

ORGANIZE SPACE LET'S REORG

- **TOOL HOLDER SYSTEM SERIES NC**

NORMAL EXTENSION DRAWERS 87%

FULL EXTENSION DRAWERS 100%

VERSATILE

SEVERAL SERIES AVAILABLE

GANZE SPACE LETS REOR

SERIES NC

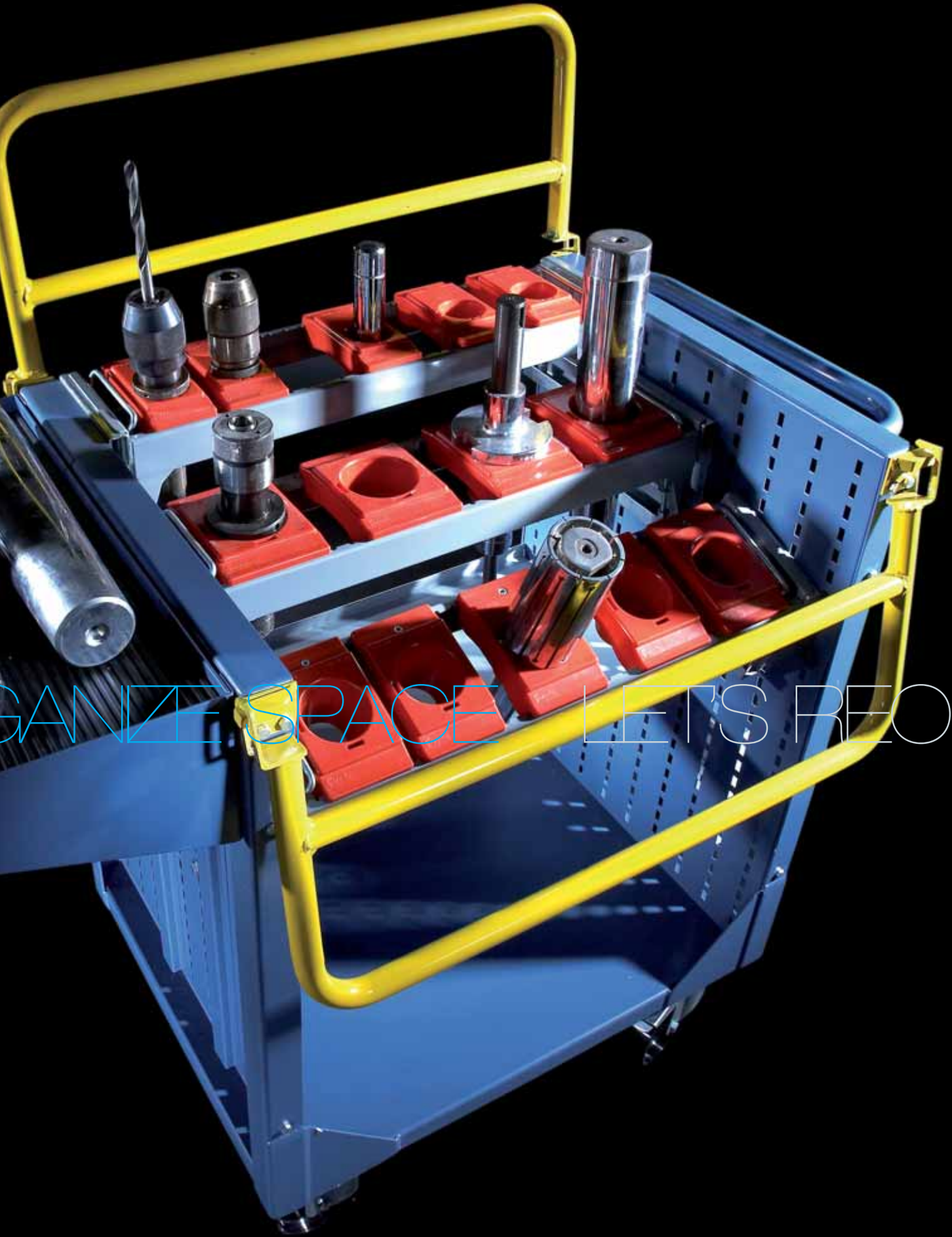

TOOL HOLDERS SERIES NC-TOOL

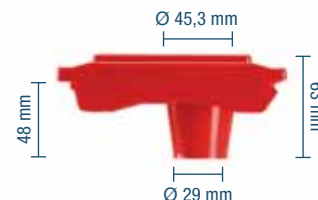
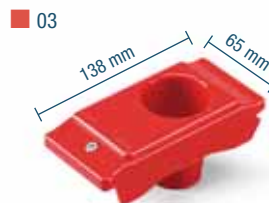
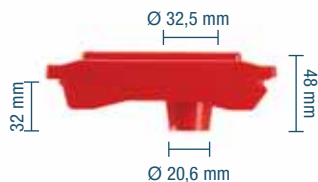
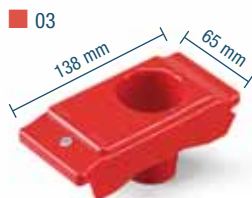

ORD. NO.	PACKAGE OF	DIMENSIONS mm
F NC 9510 00 03	1 PIECE	65x138x48 h
F NC 9510 01 03	10 PIECES	65x138x48 h

Tool holder ISO 30

ORD. NO.	PACKAGE OF	DIMENSIONS mm
F NC 9530 00 03	1 PIECE	65x138x63 h
F NC 9530 01 03	10 PIECES	65x138x63 h

Tool holder ISO 40

RED F. 03

INFO ■



www.famispa.com



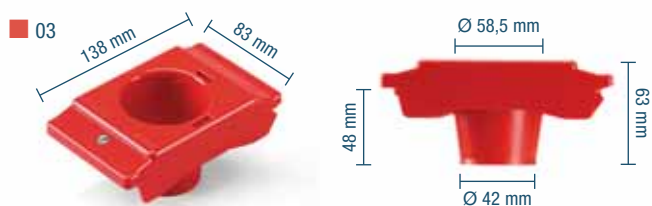

ORD. NO.	PACKAGE OF	DIMENSIONS mm
F NC 9540 00 03	1 PIECE	83x138x63 h
F NC 9540 01 03	10 PIECES	83x138x63 h

Tool holder ISO 45

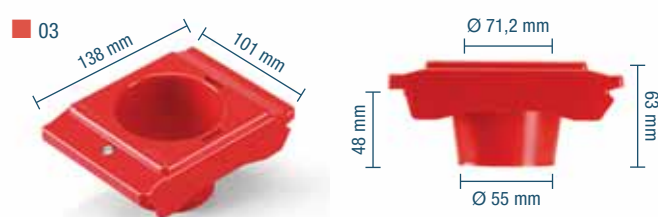

ORD. NO.	PACKAGE OF	DIMENSIONS mm
F NC 9550 00 03	1 PIECE	101x138x63 h
F NC 9550 01 03	10 PIECES	101x138x63 h

Tool holder ISO 50

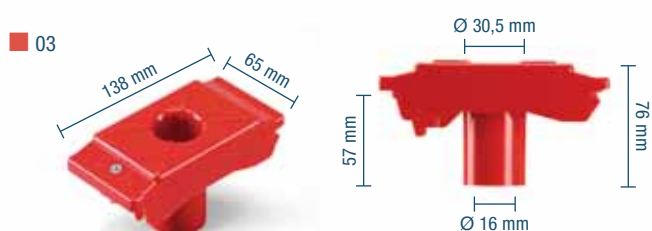

ORD. NO.	PACKAGE OF	DIMENSIONS mm
F NC 9560 00 03	1 PIECE	65x138x76 h
F NC 9560 01 03	24 PIECES	65x138x76 h

Tool holder VDI 30

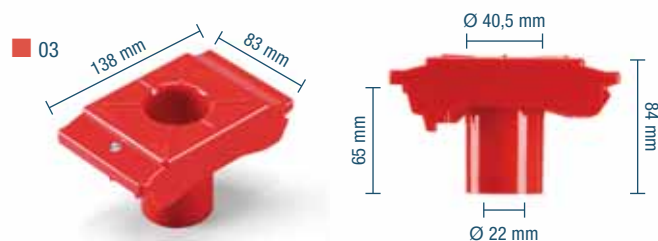

ORD. NO.	PACKAGE OF	DIMENSIONS mm
F NC 9570 00 03	1 PIECE	83x138x84 h
F NC 9570 01 03	24 PIECES	83x138x84 h

Tool holder VDI 40

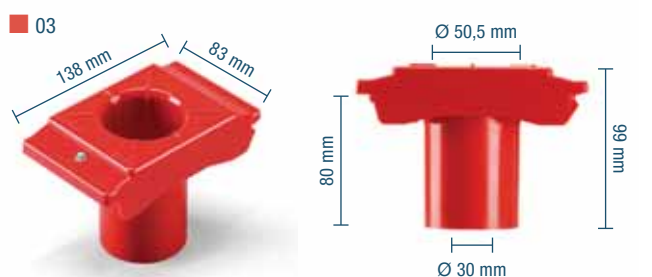

ORD. NO.	PACKAGE OF	DIMENSIONS mm
F NC 9580 00 03	1 PIECE	83x138x99 h
F NC 9580 01 03	16 PIECES	83x138x99 h

Tool holder VDI 50

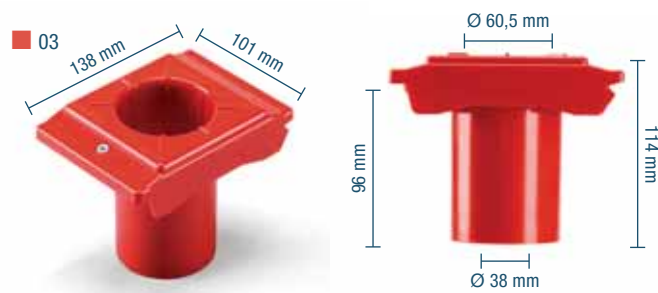

ORD. NO.	PACKAGE OF	DIMENSIONS mm
F NC 9590 00 03	1 PIECE	101x138x114 h
F NC 9590 01 03	16 PIECES	101x138x114 h

Tool holder VDI 60

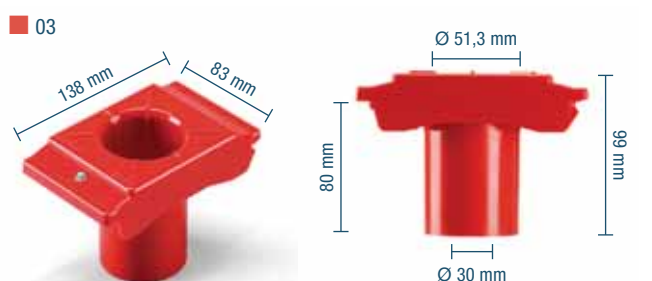

ORD. NO.	PACKAGE OF	DIMENSIONS mm
F NC 9640 00 03	1 PIECE	83x138x99 h
F NC 9640 01 03	24 PIECES	83x138x99 h

Tool holder 2"

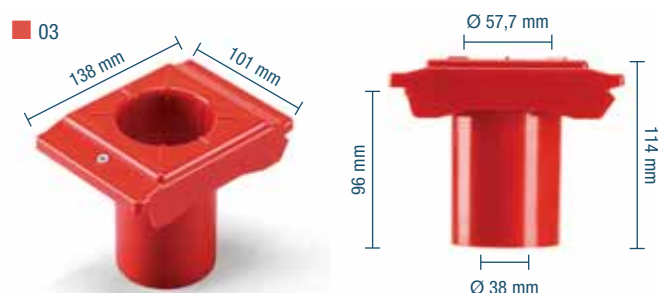

ORD. NO.	PACKAGE OF	DIMENSIONS mm
F NC 9650 00 03	1 PIECE	101x138x114 h
F NC 9650 01 03	16 PIECES	101x138x114 h

Tool holder 2" ,/4

■ INFO



www.famispa.com

RED F... .. 03

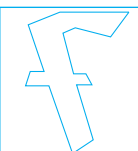

TOOL HOLDERS SERIES NC-TOOL

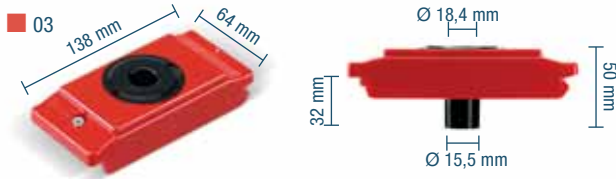

ORD. NO.	PACKAGE OF	DIMENSIONS mm
F NC 9720 00 03	1 PIECE	64x138x50 h
F NC 9720 01 03	4 PIECES	64x138x50 h

Tool holder **MORSE TAPER 2**

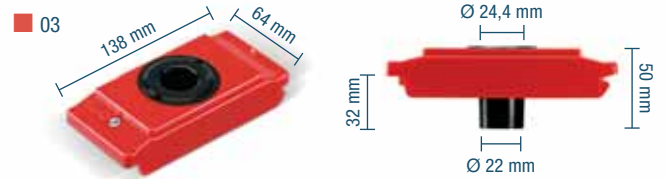

ORD. NO.	PACKAGE OF	DIMENSIONS mm
F NC 9730 00 03	1 PIECE	64x138x50 h
F NC 9730 01 03	4 PIECES	64x138x50 h

Tool holder **MORSE TAPER 3**

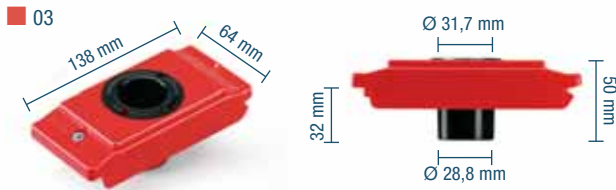

ORD. NO.	PACKAGE OF	DIMENSIONS mm
F NC 9740 00 03	1 PIECE	64x138x50 h
F NC 9740 01 03	4 PIECES	64x138x50 h

Tool holder **MORSE TAPER 4**

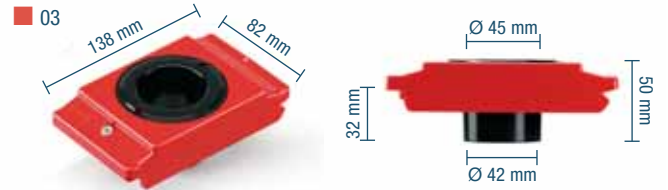

ORD. NO.	PACKAGE OF	DIMENSIONS mm
F NC 9750 00 03	1 PIECE	82x138x50 h
F NC 9750 01 03	4 PIECES	82x138x50 h

Tool holder **MORSE TAPER 5**

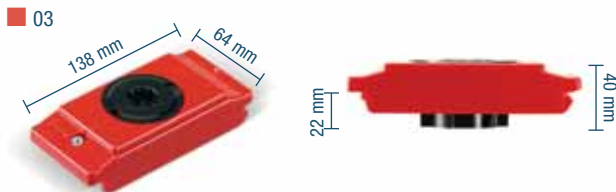

ORD. NO.	PACKAGE OF	DIMENSIONS mm
F NC 9270 00 03	1 PIECE	64x138x40 h
F NC 9270 01 03	10 PIECES	64x138x40 h

Tool holder **CAPTO C3**

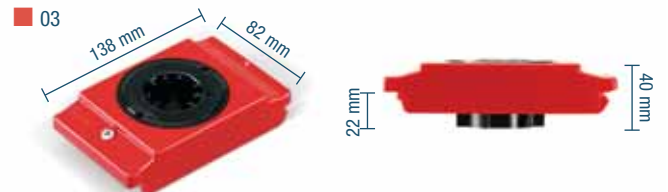

ORD. NO.	PACKAGE OF	DIMENSIONS mm
F NC 9275 00 03	1 PIECE	82x138x40 h
F NC 9275 01 03	10 PIECES	82x138x40 h

Tool holder **CAPTO C4**

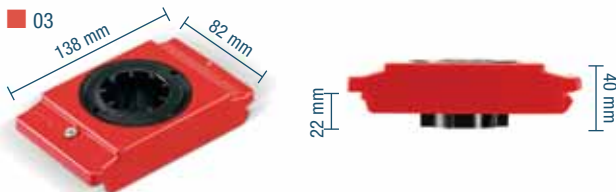

ORD. NO.	PACKAGE OF	DIMENSIONS mm
F NC 9280 00 03	1 PIECE	82x138x40 h
F NC 9280 01 03	10 PIECES	82x138x40 h

Tool holder **CAPTO C5**

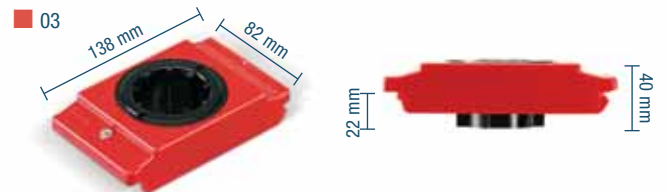

ORD. NO.	PACKAGE OF	DIMENSIONS mm
F NC 9285 00 03	1 PIECE	82x138x40 h
F NC 9285 01 03	10 PIECES	82x138x40 h

Tool holder **CAPTO C6**

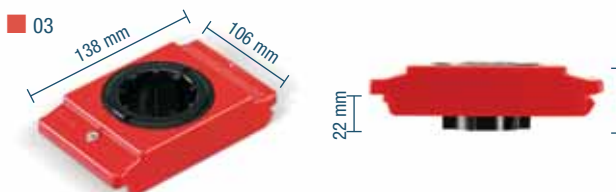

ORD. NO.	PACKAGE OF	DIMENSIONS mm
F NC 9290 00 03	1 PIECE	106x138x40 h
F NC 9290 01 03	10 PIECES	106x138x40 h

Tool holder **CAPTO C8**

RED F.. 03



INFO ■

www.famispa.com



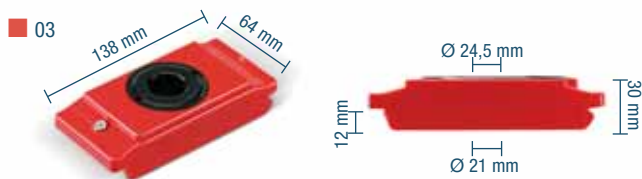

ORD. NO.	PACKAGE OF	DIMENSIONS mm H
F NC 9210 00 03	1 PIECE	64x138x30
F NC 9210 01 03	10 PIECES	64x138x30

Tool holder **HSK A32-B40**

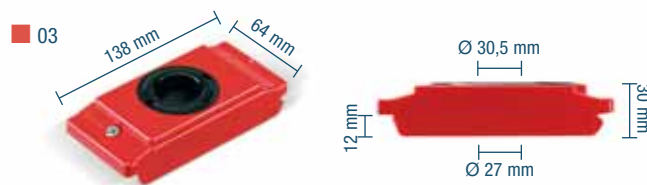

ORD. NO.	PACKAGE OF	DIMENSIONS mm
F NC 9220 00 03	1 PIECE	64x138x30 h
F NC 9220 01 03	10 PIECES	64x138x30 h

Tool holder **HSK A40-B50**

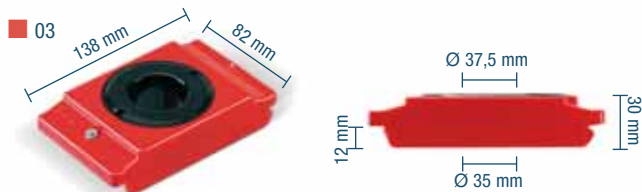

ORD. NO.	PACKAGE OF	DIMENSIONS mm
F NC 9230 00 03	1 PIECE	82x138x30 h
F NC 9230 01 03	10 PIECES	82x138x30 h

Tool holder **HSK A50-B63**

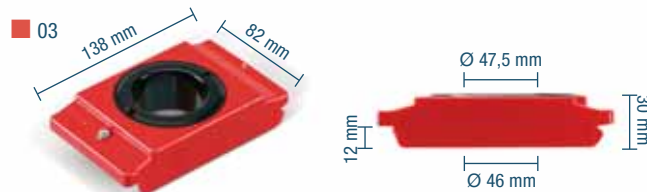

ORD. NO.	PACKAGE OF	DIMENSIONS mm
F NC 9240 00 03	1 PIECE	82x138x30 h
F NC 9240 01 03	10 PIECES	82x138x30 h

Tool holder **HSK A63-B80**

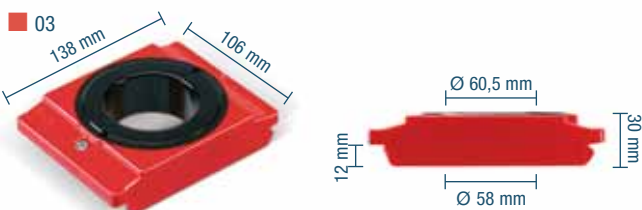

ORD. NO.	PACKAGE OF	DIMENSIONS mm
F NC 9250 00 03	1 PIECE	106x138x30 h
F NC 9250 01 03	10 PIECES	106x138x30 h

Tool holder **HSK A80-B100**

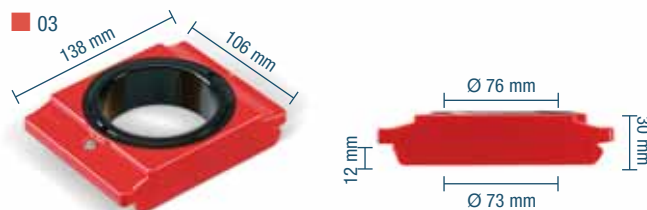

ORD. NO.	PACKAGE OF	DIMENSIONS mm
F NC 9260 00 03	1 PIECE	106x138x30 h
F NC 9260 01 03	10 PIECES	106x138x30 h

Tool holder **HSK A100-B125**

CABINET WITH LEAF DOORS

ORD. NO.

F AE 3040 S1 50

Including 4 drawers

2 tool holder frames with supports

1 cover MDF top

Dimensions mm 717x750x1030 h

Tools and tool holders excluded



■ RAL 7035 +
■ RAL 5012

■ **INFO**



www.famispa.com

RED F... .. 03



TOOL HOLDERS SERIES NC-TOOL

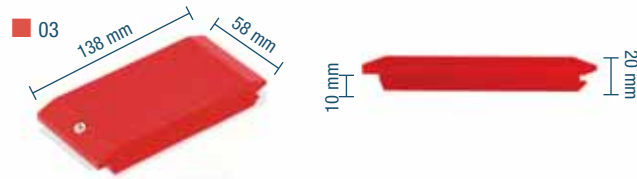

ORD. NO.	PACKAGE OF	DIMENSIONS mm
F NC 9010 00 03	1 PIECE	58x138x20 h
F NC 9010 01 03	10 PIECES	58x138x20 h

Tool holder **58 mm**

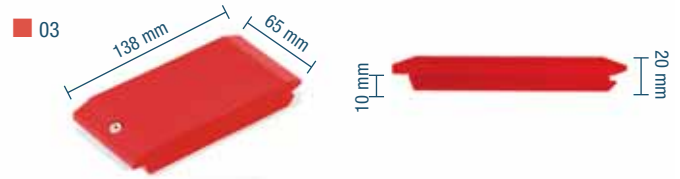

ORD. NO.	PACKAGE OF	DIMENSIONS mm
F NC 9020 00 03	1 PIECE	65x138x20 h
F NC 9020 01 03	10 PIECES	65x138x20 h

Tool holder **65 mm**

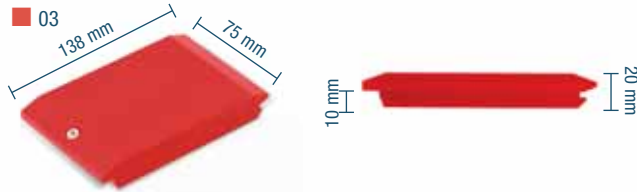

ORD. NO.	PACKAGE OF	DIMENSIONS mm
F NC 9030 00 03	1 PIECE	75x138x20 h
F NC 9030 01 03	10 PIECES	75x138x20 h

Tool holder **75 mm**

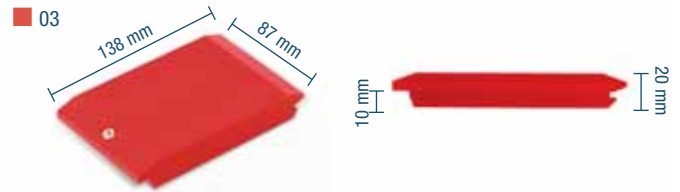

ORD. NO.	PACKAGE OF	DIMENSIONS mm
F NC 9040 00 03	1 PIECE	87x138x20 h
F NC 9040 01 03	10 PIECES	87x138x20 h

Tool holder **87 mm**

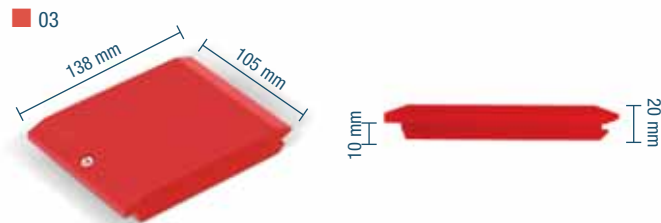

ORD. NO.	PACKAGE OF	DIMENSIONS mm
F NC 9050 00 03	1 PIECE	105x138x20 h
F NC 9050 01 03	10 PIECES	105x138x20 h

Tool holder **105 mm**



ORD. NO. TOOL HOLDERS	TOOL HOLDER TYPE	MAX. QUANTITY PER TOOL FRAME F NC 2010 00 ..
F NC 9510 00 03	ISO 30	24
F NC 9530 00 03	ISO 40	24
F NC 9540 00 03	ISO 45	18
F NC 9550 00 03	ISO 50	15
F NC 9560 00 03	VDI 30	24
F NC 9570 00 03	VDI 40	18
F NC 9580 00 03	VDI 50	18
F NC 9590 00 03	VDI 60	15
F NC 9720 00 03	MORSE TAPER 2	24
F NC 9730 00 03	MORSE TAPER 3	24
F NC 9740 00 03	MORSE TAPER 4	24
F NC 9750 00 03	MORSE TAPER 5	18
F NC 9270 00 03	CAPTO C3	24
F NC 9275 00 03	CAPTO C4	18
F NC 9280 00 03	CAPTO C5	18



ORD. NO. TOOL HOLDERS	TOOL HOLDER TYPE	MAX. QUANTITY PER TOOL FRAME F NC 2010 00 ..
F NC 9285 00 03	CAPTO C6	18
F NC 9290 00 03	CAPTO C8	12
F NC 9210 00 03	HSK A32-B40	24
F NC 9220 00 03	HSK A40-B50	24
F NC 9230 00 03	HSK A50-B63	18
F NC 9240 00 03	HSK A63-B80	18
F NC 9250 00 03	HSK A80-B100	12
F NC 9260 00 03	HSK A100-B125	12
F NC 9640 00 03	2"	18
F NC 9650 00 03	2" 1/4	15
F NC 9010 00 03	58 mm	27
F NC 9020 00 03	65 mm	24
F NC 9030 00 03	75 mm	21
F NC 9040 00 03	87 mm	18
F NC 9050 00 03	105 mm	15

RED F.. 03

INFO ■



TOOL STAND**ORD. NO.****F NC 2010 00 04**

Dimensions mm 565x450x350 h

Tool holders excluded

- 01
- 02
- 04
- 08



■ RAL 1004

- RAL 5012 +
- RAL 7000

ORD. NO.**F CN 5720 00 30**

Pair of side protections ■ RAL 1004

Dimensions mm 988x270 h

TOOL TROLLEY**ORD. NO.****F CN K600 10 51**

Including 1 frame with 4-rows

1 pair of carriers for frame 4-rows

6 frames with 1-row

4 angled carriers for frames with 1-row

2 horizontal carriers for frames with 1-row

Dimensions mm 1073x685x935 h

Tools and tool holders excluded

CABINET WITH SLIDING DOORS**ORD. NO.****F AF 1040 S1 08**

Including 4 drawers, 2 retractable shelves

2 tool holder frames

1 rubber cover top with 3 edges

Dimensions mm 1431x632x1020 h

Tools and tool holders excluded



■ RAL 7035

TROLLEY SERIES NC-COMBI



ORD. NO. F CN K600 06 51
RAL 5012+7000

ORD. NO. F CN F100 06 51
RAL 5012+7000

TOOL TROLLEY

ORD. NO.

F CN F100 06 51

Dimensions mm 1064x512x890 h

Tool holders excluded

ORD. NO.

F CN 5710 00 30

Pair of side protections ■ RAL 1004

Dimensions mm 690x270 h

TOOL TROLLEY

ORD. NO.

F CN K600 06 51

Dimensions mm 1073x685x935h

Tool holders excluded

TOOL TROLLEY

ORD. NO.

F CN F100 10 51

Dimensions mm 1064x512x890 h

Tool holders excluded



■ RAL 1004

■ RAL 5012 +
■ RAL 7000

RAL 7000 F... ..01 RAL 6011 F... ..02 RAL 5012 + RAL 7000 F... ..51 RAL 7035 + RAL 7000 F... ..56

KEY ■

■ Partitioning material: see page B47

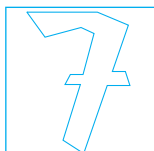

LENGTH = 1064 mm DEPTH = 512 mm

TROLLEY SERIES NC-COMBI

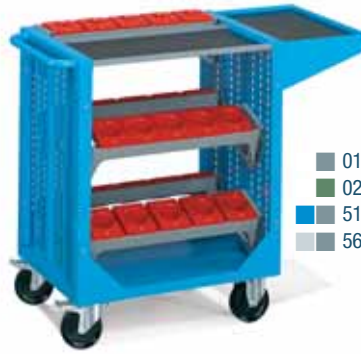
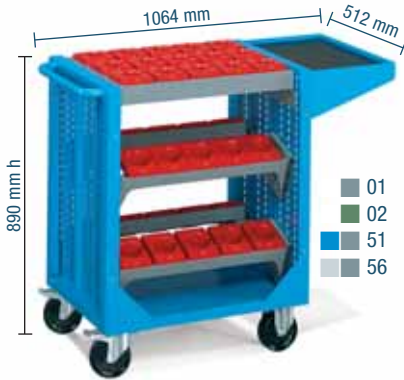

ORD. NO. TROLLEY LOAD CAPACITY kg

F CN F100 01 51 500

Including:

- 2 nylon swivel wheels with brake Ø 125 mm
- 2 nylon fixed wheels Ø 125 mm
- 1 tool holder frame 3-rows ORD. NO. **F NC 5120 00 01**
- 1 pair of carriers ORD. NO. **F NC 5620 00 01**
- 4 tool holder frames 1-row ORD. NO. **F NC 5020 00 01**
- 4 pair of angled carriers ORD. NO. **F NC 5711 00 99**
- 1 shelf ORD. NO. **F CN 5510 00 04**
- 1 rubber mat ORD. NO. **F CN 5210 00 07**

Dimensions mm 1064x512x890 h

Tool holders excluded

ORD. NO. TROLLEY LOAD CAPACITY kg

F CN F100 06 51 500

Including:

- 2 nylon swivel wheels with brake Ø 125 mm
- 2 nylon fixed wheels Ø 125 mm in
- 5 tool holder frames 1-row ORD. NO. **F NC 5020 00 01**
- 4 pair of angled carriers ORD. NO. **F NC 5711 00 99**
- 1 pair of horizontal carriers ORD. NO. **F NC 5710 00 99**
- 1 shelf ORD. NO. **F CN 5510 00 04**
- 1 rubber mat ORD. NO. **F CN 5210 00 07**
- 1 adjustable shelf ORD. NO. **F CN 5100 00 01**
- 1 rubber mat ORD. NO. **F CN 5220 00 07**

Dim. mm 1064x512x890 h Tool holders excluded

ORD. NO. TROLLEY LOAD CAPACITY kg

F CN F100 10 51 500

Including:

- 2 nylon swivel wheels with brake Ø 125 mm
- 2 nylon fixed wheels Ø 125 mm
- 1 tool holder frame 3-rows ORD. NO. **F NC 5120 00 01**
- 1 pair of carriers ORD. NO. **F NC 5620 00 01**
- 2 tool holder frames 1-row ORD. NO. **F NC 5020 00 01**
- 2 pair of angled carriers ORD. NO. **F NC 5711 00 99**
- 1 shelf ORD. NO. **F CN 5510 00 04**
- 1 rubber mat ORD. NO. **F CN 5210 00 07**

Dimensions mm 1064x512x890 h

Tool holders excluded

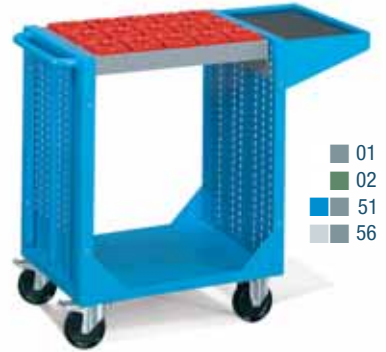

ORD. NO. TROLLEY LOAD CAPACITY kg

F CN F100 07 51 500

Including:

- 2 nylon swivel wheels with brake Ø 125 mm
- 2 nylon fixed wheels Ø 125 mm
- 4 tool holder frames 1-row ORD. NO. **F NC 5020 00 01**
- 4 pair of angled carriers ORD. NO. **F NC 5711 00 99**
- 1 shelf ORD. NO. **F CN 5510 00 04**
- 1 rubber mat ORD. NO. **F CN 5210 00 07**

Dimensions mm 1064x512x890 h

Tool holders excluded

ORD. NO. TROLLEY LOAD CAPACITY kg

F CN F100 11 51 500

Including:

- 2 nylon swivel wheels with brake Ø 125 mm
- 2 nylon fixed wheels Ø 125 mm
- 5 tool holder frames 1-row ORD. NO. **F NC 5020 00 01**
- 4 pair of angled carriers ORD. NO. **F NC 5711 00 99**
- 1 pair of horizontal carriers ORD. NO. **F NC 5710 00 99**
- 1 shelf ORD. NO. **F CN 5510 00 04**
- 1 rubber mat ORD. NO. **F CN 5210 00 07**

Dim. mm 1064x512x890 h Tool holders excluded

ORD. NO. TROLLEY LOAD CAPACITY kg

F CN F100 08 51 500

Including:

- 2 nylon swivel wheels with brake Ø 125 mm
- 2 nylon fixed wheels Ø 125 mm
- 1 tool holder frame 3-rows ORD. NO. **F NC 5120 00 01**
- 1 pair of carriers ORD. NO. **F NC 5620 00 01**
- 1 shelf ORD. NO. **F CN 5510 00 04**
- 1 rubber mat ORD. NO. **F CN 5210 00 07**

Dimensions mm 1064x512x890 h

Tool holders excluded

KEY

RAL 7000 F... ..01 RAL 6011 F... ..02 RAL 5012 + RAL 7000 F... ..51 RAL 7035 + RAL 7000 F... ..56



- Tool holders: see page B11
- All indicated loads are net and refer to evenly distributed weights.

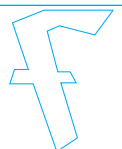

TROLLEY SERIES NC-COMBI

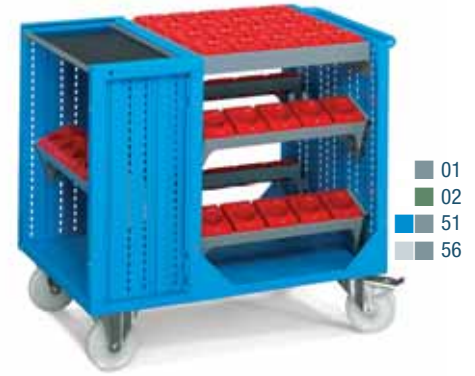
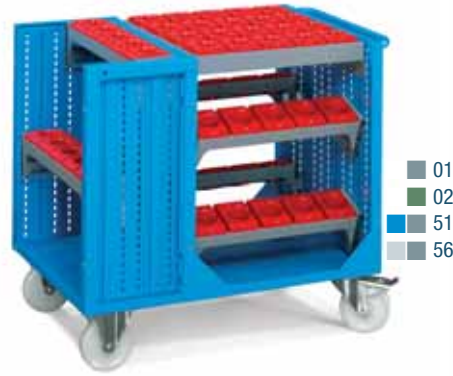
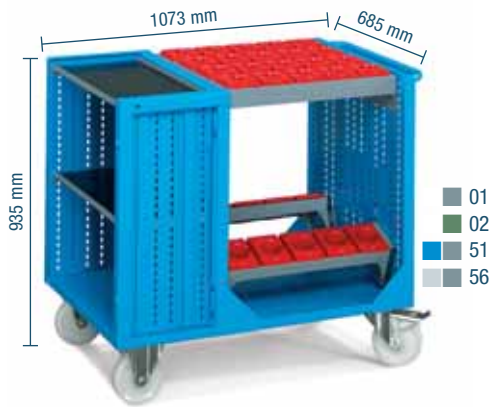

ORD. NO.	TROLLEY LOAD CAPACITY kg
F CN K600 08 51	840
Including:	
2 nylon swivel wheels with brake Ø 160 mm	
2 nylon fixed wheels Ø 160 mm	
1 tool holder frame 4-rows ORD. NO. F NC 5220 00 01	
1 pair of carriers ORD. NO. F NC 5640 00 01	
2 tool holder frames 1-row ORD. NO. F NC 5020 00 01	
2 pair of angled carriers ORD. NO. F NC 5711 00 99	
2 adjustable shelves ORD. NO. F CN 5100 00 01	
2 rubber mat ORD. NO. F CN 5220 00 07	
Dimensions mm 1073x685x935 h	
Tool holders excluded	

ORD. NO.	TROLLEY LOAD CAPACITY kg
F CN K600 10 51	840
Including:	
2 nylon swivel wheels with brake Ø 160 mm	
2 nylon fixed wheels Ø 160 mm	
1 tool holder frame 4-rows ORD. NO. F NC 5220 00 01	
1 pair of carriers ORD. NO. F NC 5640 00 01	
6 tool holder frames 1-row ORD. NO. F NC 5020 00 01	
4 pair of angled carriers ORD. NO. F NC 5711 00 99	
2 pair of horizontal carriers ORD. NO. F NC 5710 00 99	
Dimensions mm 1073x685x935 h	
Tool holders excluded	

ORD. NO.	TROLLEY LOAD CAPACITY kg
F CN K600 09 51	840
Including:	
2 nylon swivel wheels with brake Ø 160 mm	
2 nylon fixed wheels Ø 160 mm	
1 tool holder frame 4-rows ORD. NO. F NC 5220 00 01	
1 pair of carriers ORD. NO. F NC 5640 00 01	
5 tool holder frames 1-row ORD. NO. F NC 5020 00 01	
5 pair of angled carriers ORD. NO. F NC 5711 00 99	
1 adjustable shelf ORD. NO. F CN 5100 00 01	
1 rubber mat ORD. NO. F CN 5220 00 07	
Dimensions mm 1073x685x935 h	
Tool holders excluded	



ORD. NO.	TROLLEY LOAD CAPACITY kg
F CN K600 06 51	840
Including:	
2 nylon swivel wheels with brake Ø 160 mm	
2 nylon fixed wheels Ø 160 mm	
1 tool holder frame 4-rows ORD. NO. F NC 5220 00 01	
1 pair of carriers ORD. NO. F NC 5640 00 01	
4 tool holder frames 1-row ORD. NO. F NC 5020 00 01	
2 pair of angled carriers ORD. NO. F NC 5711 00 99	
2 pair of horizontal carriers ORD. NO. F NC 5710 00 99	
1 adjustable shelf ORD. NO. F CN 5120 00 01	
1 rubber mat ORD. NO. F CN 5240 00 07	
2 adjustable shelves ORD. NO. F CN 5100 00 01	
2 rubber mat ORD. NO. F CN 5220 00 07	
1 empty drawer ORD. NO. F NC 8610 00 04	
Dim. mm 1073x685x935 h Tool holders excluded	

RAL 7000 F... ..01 RAL 6011 F... ..02 RAL 5012 + RAL 7000 F... ..51 RAL 7035 + RAL 7000 F... ..56

KEY ■

■ All indicated loads are net and refer to evenly distributed weights.



TROLLEY SERIES NC-COMBI

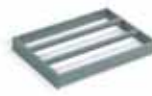

ORD. NO. TOOL HOLDERS	TOOL HOLDER TYPE	MAX. QUANTITY PER TOOL FRAME F NC 5020 00 ..	MAX. QUANTITY PER TOOL FRAME F NC 5120 00 ..	MAX. QUANTITY PER TOOL FRAME F NC 5220 00 ..
F NC 9510 00 03	ISO 30	7	24	32
F NC 9530 00 03	ISO 40	7	24	32
F NC 9540 00 03	ISO 45	5	18	24
F NC 9550 00 03	ISO 50	5	15	20
F NC 9560 00 03	VDI 30	7	24	32
F NC 9570 00 03	VDI 40	5	18	24
F NC 9580 00 03	VDI 50	5	18	24
F NC 9590 00 03	VDI 60	5	15	20
F NC 9720 00 03	MORSE TAPER 2	7	24	32
F NC 9730 00 03	MORSE TAPER 3	7	24	32
F NC 9740 00 03	MORSE TAPER 4	7	24	32
F NC 9750 00 03	MORSE TAPER 5	5	18	24
F NC 9270 00 03	CAPTO C3	7	24	32
F NC 9275 00 03	CAPTO C4	5	18	24
F NC 9280 00 03	CAPTO C5	5	18	24
F NC 9285 00 03	CAPTO C6	5	18	24
F NC 9290 00 03	CAPTO C8	4	12	16
F NC 9210 00 03	HSK A32-B40	7	24	32
F NC 9220 00 03	HSK A40-B50	7	24	32
F NC 9230 00 03	HSK A50-B63	5	18	24
F NC 9240 00 03	HSK A63-B80	5	18	24
F NC 9250 00 03	HSK A80-B100	4	12	16
F NC 9260 00 03	HSK A100-B125	4	12	16
F NC 9640 00 03	2"	5	18	24
F NC 9650 00 03	2" 1/4	5	15	20
F NC 9010 00 03	58 mm	9	27	36
F NC 9020 00 03	65 mm	8	24	32
F NC 9030 00 03	75 mm	7	21	28
F NC 9040 00 03	87 mm	6	18	24
F NC 9050 00 03	105 mm	5	15	20



■ INFO

RAL 7000 F... ..01 RAL 6011 F... ..02 RAL 5012 + RAL 7000 F... ..51 RAL 7035 + RAL 7000 F... ..56



www.famispa.com

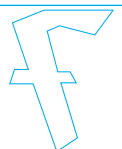

TROLLEY SERIES NC-COMBI

TOOL TROLLEY F CN 0100 (NC102)

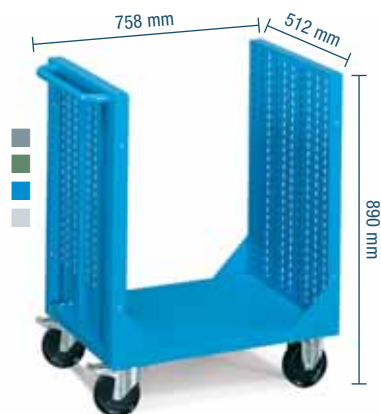

ORD. NO. TROLLEY LOAD CAPACITY kg
F CN 100 00 04 500
Including: 2 nylon swivel wheels with brake Ø 125 mm,
2 nylon fixed wheels Ø 125 mm
Dimensions mm 758x512x890 h

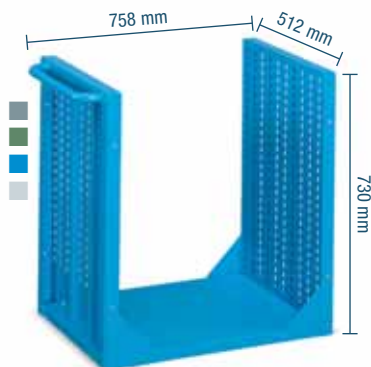

ORD. NO.
F CN 0100 00 04
Trolley prepared for wheels:
Ø 100 mm / 125 mm / 150 mm
Dimensions mm 758x512x730 h

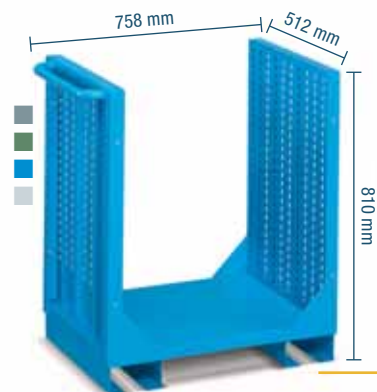

ORD. NO.
F CN 0101 00 04
Including: 2 fork lift base prepared for wheels
Ø 100 mm / 125 mm / 150 mm
Dimensions mm 758x512x810 h

1 ORD. NO. F CN 5210 00 07

Rubber mat for shelf
ORD. NO. F CN 5510 00 ..
Overall dimensions mm: **485x300**

2 ORD. NO. F CN 5510 00 01 ■ RAL 7000

2 ORD. NO. F CN 5510 00 02 ■ RAL 6011

2 ORD. NO. F CN 5510 00 04 ■ RAL 5012

2 ORD. NO. F CN 5510 00 08 ■ RAL 7035

Shelf dimensions mm: **490x300x170 h**

3 ORD. NO. F CN 5220 00 07

Rubber mat for adjustable shelf
ORD. NO. F CN 5100 00 ..
Overall dimensions mm: **595x295**

4 ORD. NO. F CN 5100 00 01 ■ RAL 7000

4 ORD. NO. F CN 5100 00 02 ■ RAL 6011

Height adjustable shelf

Overall dimensions mm: **600x300x42 h**

Load capacity: 30 kg

5 ORD. NO. F CN 5250 00 07

Rubber mat for bottom shelf of
trolley
Overall dimensions mm: **595x495**

6 ORD. NO. F CN 5230 00 07

Rubber mat for adjustable shelf
ORD. NO. F CN 5110 00 ..
Overall dimensions mm: **595x455**

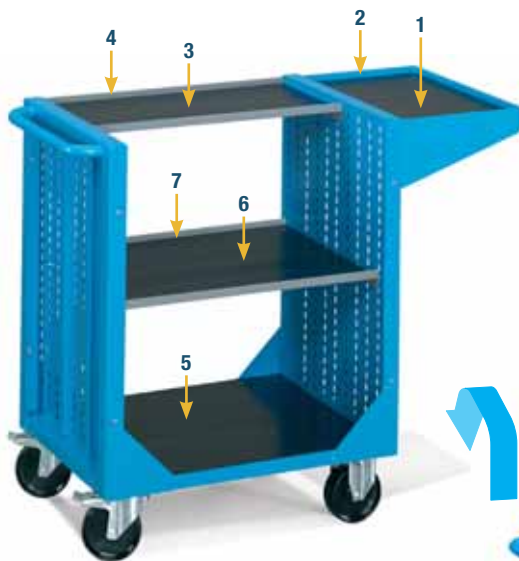

7 ORD. NO. F CN 5110 00 01 ■ RAL 7000

7 ORD. NO. F CN 5110 00 02 ■ RAL 6011

Height adjustable shelf

Overall dimensions mm: **600x460x42 h**

Load capacity: 30 kg

8+9 ORD. NO. F CN 5710 00 30 ■ RAL 1004

Pair of side protections for trolley series CN 0100

Overall dimensions mm: **690x270 h**

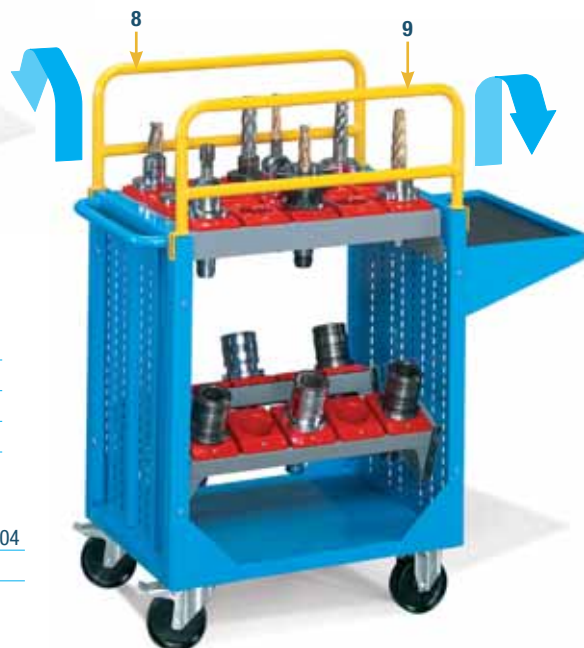

RAL 7000 F... ..01 RAL 6011 F... ..02 RAL 5012 F... ..04 RAL 7035 F... ..08

KEY ■

■ Wheels
see page
B18

■ All indicated loads are net and refer to evenly distributed weights.



LENGTH = 1073 mm DEPTH = 685 mm

TROLLEY SERIES NC-COMBI

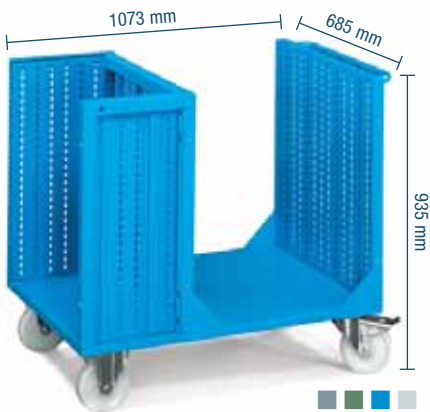

ORD. NO. TROLLEY LOAD CAPACITY kg

F CN K600 00 04 840
Including: 2 nylon swivel wheels with brake Ø 160 mm,
2 fixed wheels Ø 160 mm in nylon
Dimensions mm 1073x685x935 h

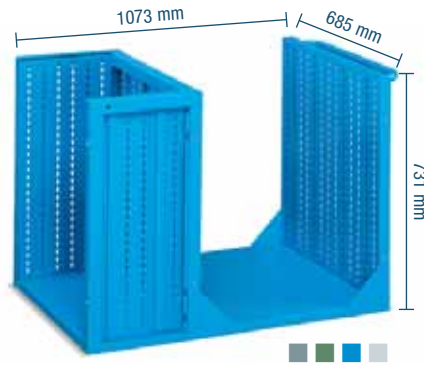

ORD. NO.

F CN 0600 00 04
Trolley prepared for wheels: Ø 160 mm / 200 mm
Dimensions mm 1073x685x731 h

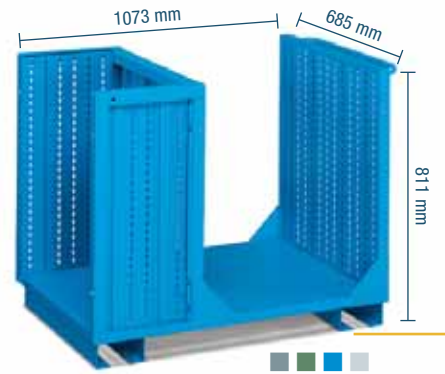

ORD. NO.

F CN 0601 00 04
Including: 2 fork lift base prepared for wheels
Ø 160 mm / 200 mm
Dimensions mm 1073x685x811 h

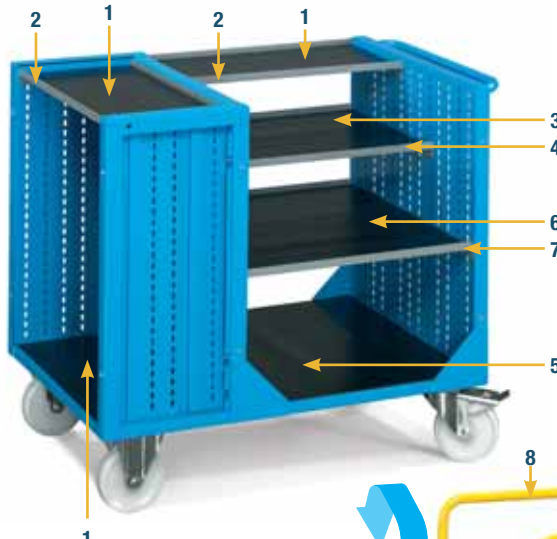

1 ORD. NO. F CN 5220 00 07
Rubber mat for adjustable shelf
ORD. NO. F CN 5100 00 ..
Overall dimensions mm: 595x295

2 ORD. NO. F CN 5100 00 01 ■ RAL 7000
2 ORD. NO. F CN 5100 00 02 ■ RAL 6011
Height adjustable shelf
Overall dimensions mm: 600x300x42 h
Load capacity: 30 kg

3 ORD. NO. F CN 5230 00 07
Rubber mat for adjustable shelf
ORD. NO. F CN 5110 00 ..
Overall dimensions mm: 595x455

4 ORD. NO. F CN 5110 00 01 ■ RAL 7000
4 ORD. NO. F CN 5110 00 02 ■ RAL 6011
Height adjustable shelf
Overall dimensions mm: 600x460x42 h
Load capacity: 30 kg

5 ORD. NO. F CN 5260 00 07
Rubber mat for bottom shelf of trolley
Overall dimensions mm: 675x595

6 ORD. NO. F CN 5240 00 07
Rubber mat for adjustable shelf
ORD. NO. F CN 5120 00 ..
Overall dimensions mm: 595x655

7 ORD. NO. F CN 5120 00 01 ■ RAL 7000
7 ORD. NO. F CN 5120 00 02 ■ RAL 6011
Height adjustable shelf
Overall dimensions mm: 600x660x42 h
Load capacity: 30 kg

8+9 ORD. NO. F CN 5720 00 30 ■ RAL 1004
Pair of side protections per carrello serie CN 0600
Overall dimensions mm: 988x270 h

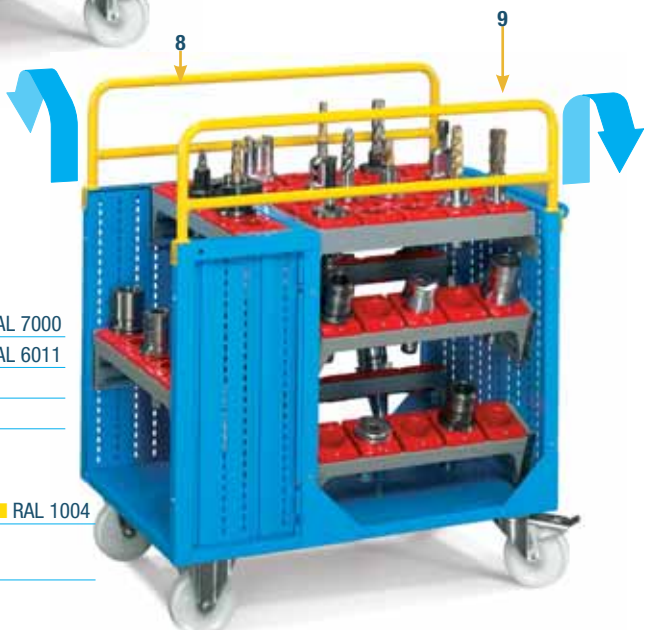

■ KEY

■ RAL 7000 F... ..01 ■ RAL 6011 F... ..02 ■ RAL 5012 F... ..04 ■ RAL 7035 F... ..08

■ Wheels see page B19

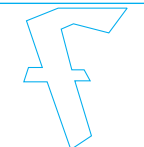

■ All indicated loads are net and refer to evenly distributed weights.

TROLLEY SERIES NC-COMBI

TOOL HOLDER FRAME AND ACCESSORIES FOR TOOL TROLLEY F CN 0100 (NC102) / F CN 0600 (NC104)



TOOL HOLDER FRAME

ORD. NO.

F NC 5020 00 01

Horizontal frame load capacity: **50 kg**

Dimensions mm 584x140x146 h

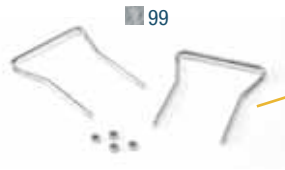

PAIR OF GALVANISED HANDLES

ORD. NO.

F NC 5005 00 99

For frame ORD. NO. F NC 5020 00 ..



PAIR OF GALVANISED TOOL HOLDER FRAME CARRIERS, HORIZONTAL

ORD. NO.

F NC 5710 00 99

For frame ORD. NO. F NC 5020 00 ..

Overall dimensions mm 140x150 h

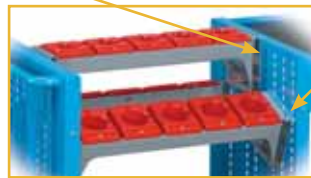

PAIR OF GALVANISED TOOL HOLDER FRAME CARRIERS, ANGLED

ORD. NO.

F NC 5711 00 99

For frame ORD. NO. F NC 5020 00 ..

Overall dimensions mm 140x150 h

TOOL HOLDER FRAME 3-ROWS AND ACCESSORIES FOR TROLLEYS F CN 0100 (NC102)



TOOL HOLDER FRAME 3-ROWS

ORD. NO.

F NC 5120 00 01

Horizontal frame load capacity: **150 kg**

Overall dimensions mm 584x444x69 h

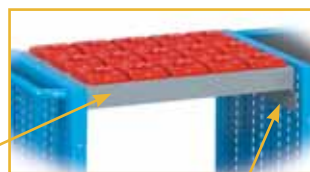

HORIZONTAL PAIR OF CARRIERS

ORD. NO.

F NC 5620 00 01

For frame ORD. NO. F NC 5120 00 ..

Overall dimensions mm 430x112 h



ANGLED PAIR OF CARRIERS

ORD. NO.

F NC 5721 00 01

For frame ORD. NO. F NC 5120 00 ..

Overall dimensions mm 430x114 h

RAL 7000 F... ..01 RAL 6011 F... ..02 ZINCATO F... ..99

KEY ■

■ All indicated loads are net and refer to evenly distributed weights.



TOOL HOLDER FRAME 4-ROWS AND ACCESSORIES FOR TROLLEYS F CN 0600 (NC104)



■ 01
■ 02

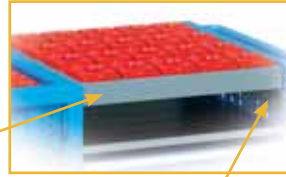

■ 01
■ 02



■ 01
■ 02

TOOL HOLDER FRAME 4 ROWS

ORD. NO.

F NC 5220 00 01

Horizontal frame load capacity: **150 kg**

Overall dimensions mm **584x592x69 h**

HORIZONTAL PAIR OF CARRIERS

ORD. NO.

F NC 5640 00 01

For frame ORD. NO. **F NC 5220 00 ..**

Overall dimensions mm **577x112 h**

ANGLED PAIR OF CARRIERS

ORD. NO.

F NC 5741 00 01

For frame ORD. NO. **F NC 5220 00 ..**

Overall dimensions mm **577x114 h**



**ORD. NO.
TOOL HOLDERS**

TOOL HOLDER
TYPE

MAX. QUANTITY PER TOOL
FRAME F NC 5020 00 ..

MAX. QUANTITY PER TOOL
FRAME F NC 5120 00 ..

MAX. QUANTITY PER TOOL
FRAME F NC 5220 00 ..

ORD. NO. TOOL HOLDERS	TOOL HOLDER TYPE	MAX. QUANTITY PER TOOL FRAME F NC 5020 00 ..	MAX. QUANTITY PER TOOL FRAME F NC 5120 00 ..	MAX. QUANTITY PER TOOL FRAME F NC 5220 00 ..
F NC 9510 00 03	ISO 30	7	24	32
F NC 9530 00 03	ISO 40	7	24	32
F NC 9540 00 03	ISO 45	5	18	24
F NC 9550 00 03	ISO 50	5	15	20
F NC 9560 00 03	VDI 30	7	24	32
F NC 9570 00 03	VDI 40	5	18	24
F NC 9580 00 03	VDI 50	5	18	24
F NC 9590 00 03	VDI 60	5	15	20
F NC 9720 00 03	MORSE TAPER 2	7	24	32
F NC 9730 00 03	MORSE TAPER 3	7	24	32
F NC 9740 00 03	MORSE TAPER 4	7	24	32
F NC 9750 00 03	MORSE TAPER 5	5	18	24
F NC 9270 00 03	CAPTO C3	7	24	32
F NC 9275 00 03	CAPTO C4	5	18	24
F NC 9280 00 03	CAPTO C5	5	18	24
F NC 9285 00 03	CAPTO C6	5	18	24
F NC 9290 00 03	CAPTO C8	4	12	16
F NC 9210 00 03	HSK A32-B40	7	24	32
F NC 9220 00 03	HSK A40-B50	7	24	32
F NC 9230 00 03	HSK A50-B63	5	18	24
F NC 9240 00 03	HSK A63-B80	5	18	24
F NC 9250 00 03	HSK A80-B100	4	12	16
F NC 9260 00 03	HSK A100-B125	4	12	16
F NC 9640 00 03	2"	5	18	24
F NC 9650 00 03	2" 1/4	5	15	20
F NC 9010 00 03	58 mm	9	27	36
F NC 9020 00 03	65 mm	8	24	32
F NC 9030 00 03	75 mm	7	21	28
F NC 9040 00 03	87 mm	6	18	24
F NC 9050 00 03	105 mm	5	15	20

■ KEY

RAL 7000 F... ..01 RAL 6011 F... ..02



■ All indicated loads are net and refer to evenly distributed weights.

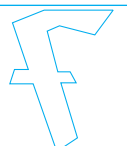

TROLLEY SERIES NC-COMBI

TOOL HOLDER FRAME FOR WOODEN INSERT OF MULTIPLEX FOR TROLLEYS F CN 0100 (NC102) / F CN 0600 (NC104)

- 01
- 02



TOOL FOR WOODEN INSERT OF MULTIPLEX

ORD. NO.

F NC 5021 00 01

Horizontal frame load capacity: 50 kg

Overall dimensions mm 584x140x146 h



WOODEN INSERT OF MULTIPLEX

ORD. NO.

F NC 2510 00 00

Overall dimensions mm 525x138x50 h



Example of tool holder frame
ORD. NO. **F NC 5021 00 ..** with
wooden insert

ALUMINIUM INSERT FOR TROLLEYS
F CN 0100 (NC102) / F CN 0600 (NC104)



ORD. NO.

F NC 2410 00 00

Aluminium insert with rubber

Overall dim. mm 525x135x45 h



Example of tool holder frame ORD. NO. **F NC 5020 00 ..** with aluminium support

DRAWING POCKET FOR TROLLEYS
F CN 0100 (NC102) / F CN 0600 (NC104)

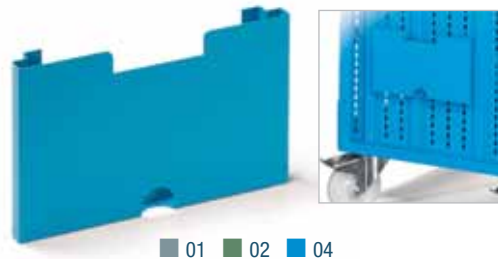

- 01
- 02
- 04

ORD. NO.

F CN 5560 00 04

Drawing pocket for size DIN A4

Overall dimensions mm 312x35x190 h

TOOLING SHELF FOR TROLLEYS
F CN 0100 (NC102) / F CN 0600 (NC104)

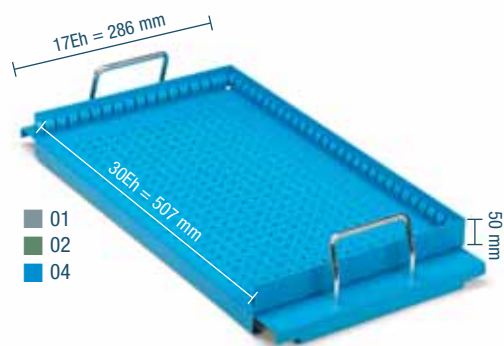

- 01
- 02
- 04

ORD. NO.

F CN 5320 00 04

Tooling shelf

Overall dimensions mm 598x303x59 h

DRAWERS 31,5x27 EH FULL TELESCOPIC EXTENSION FOR TROLLEYS
F CN 0600 (NC104)



- 01
- 02
- 04
- 08



■ Drawers including the single drawer opening device.

■ It is not possible to insert tool holder frames in these drawers.

■ Partitioning material: see page B47

ORD. NO.

FRONT HEIGHT mm

LOAD CAPACITY kg

USABLE DIM. mm

F NC 8607 00 04

75

30

523x447x54 h

F NC 8610 00 04

100

30

523x447x79 h

F NC 8615 00 04

150

30

523x447x129 h

Extension 100%

- RAL 7000 F... ..01
- RAL 6011 F... ..02
- RAL 5012 F... ..04
- RAL 7035 F... ..08

KEY ■

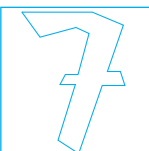

■ All indicated loads are net and refer to evenly distributed weights.

■ Partitioning material: see page A180



Arbor holders

Cutter holders

TRAVERSE GUARDS FOR TROLLEYS F CN 0600 (NC104)



A ORD. NO. F CN 3010 00 01 ■ RAL 7000

A ORD. NO. F CN 3010 00 02 ■ RAL 6011

Perforated traverse guards

Overall dimensions mm: 623x28x50 h

B ORD. NO. F CN 3030 00 07

Neoprene cover



FIXING BRACKET

ORD. NO.	FOR TOOLS Ø MAX. mm	REQUIRED Q.TY OF FIXING BRACKETS	QUANTITY UNITS
F CN 3105 00 99	15	16	2
F CN 3110 00 99	27	12	3
F CN 3115 00 99	35	9	4
F CN 3120 00 99	48	8	5
F CN 3125 00 99	60	6	6
F CN 3130 00 99	73	6	7
F CN 3135 00 99	85	5	8
F CN 3140 00 99	98	4	9
F CN 3145 00 99	110	4	10
F CN 3150 00 99	123	4	11
F CN 3155 00 99	135	3	12



TOOL HANGING FRAMES FOR TROLLEYS F CN 0600 (NC104)



ORD. NO.	FOR TOOLS	Ø MAX. mm	MAX. Q.TY OF TOOLS	WIDTH mm	DEPTH mm
F CN 3210 00 01	ISO 40	63/50	9	597	56
F CN 3220 00 01	ISO 45	82/63	7	597	75
F CN 3230 00 01	ISO 50	98/80	5	597	84
F CN 3240 00 01	ISO 50	112/80	5	597	100
F CN 3260 00 01	ISO 55	130/89	4	597	120
F CN 3270 00 01	ISO 60	160/109	3	597	140

■ INFO

RAL 7000 F... ..01 RAL 6011 F... ..02 RAL 5012 F... ..04 RAL 7035 F... ..08

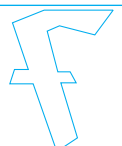

WHEELS SERIES NC-COMBI

STANDARD RUBBER



SWIVEL WHEEL WITH BRAKE

ORD. NO.	Ø mm	C mm	LOAD CAPACITY kg
C RG DAC11 100	100	130	75
C RG DAC12 125	125	160	100
C RG DAC13 150	150	185	115



FIXED WHEEL

ORD. NO.	Ø mm	C mm	LOAD CAPACITY kg
C RG BAC11 100	100	130	75
C RG BAC12 125	125	160	100
C RG BAC13 150	150	185	115

NYLON



SWIVEL WHEEL WITH BRAKE

ORD. NO.	Ø mm	C mm	LOAD CAPACITY kg
C RN DAD10 100	100	130	125
C RN DAD11 125	125	160	180



FIXED WHEEL

ORD. NO.	Ø mm	C mm	LOAD CAPACITY kg
C RN BAD10 100	100	130	125
C RN BAD11 125	125	160	180

NO-SMEAR RUBBER



SWIVEL WHEEL WITH BRAKE

ORD. NO.	Ø mm	C mm	LOAD CAPACITY kg
C RG DPH22 125	125	160	100



FIXED WHEEL

ORD. NO.	Ø mm	C mm	LOAD CAPACITY kg
C RG BPH22 125	125	160	100

ELASTIC RUBBER



SWIVEL WHEEL WITH BRAKE

ORD. NO.	Ø mm	C mm	LOAD CAPACITY kg
C RG DCE15 125	125	160	180



FIXED WHEEL

ORD. NO.	Ø mm	C mm	LOAD CAPACITY kg
C RG BCE15 125	125	160	180

POLYURETHANE



SWIVEL WHEEL WITH BRAKE

ORD. NO.	Ø mm	C mm	LOAD CAPACITY kg
C RN DDD31 125	125	160	180



FIXED WHEEL

ORD. NO.	Ø mm	C mm	LOAD CAPACITY kg
C RN BDD31 125	125	160	180

KEY ■

- Follow the formula to calculate the load capacity of the trolley:
 $(A \times 3) - 40 \text{ kg}$
 A = load capacity of the wheel
 40 kg = average weight of the trolley



WHEELS

WHEELS SERIES NC-COMBI



SWIVEL WHEEL WITH BRAKE

ORD. NO.	Ø mm	C mm	LOAD CAPACITY kg
C RG DAC15 200	200	242	205



FIXED WHEEL

ORD. NO.	Ø mm	C mm	LOAD CAPACITY kg
C RG BAC15 200	200	242	205

NYLON



SWIVEL WHEEL WITH BRAKE

ORD. NO.	Ø mm	C mm	LOAD CAPACITY kg
C RN DAD04 160	160	204	300



FIXED WHEEL

ORD. NO.	Ø mm	C mm	LOAD CAPACITY kg
C RN BAD04 160	160	204	300

NO-SMEAR RUBBER



SWIVEL WHEEL WITH BRAKE

ORD. NO.	Ø mm	C mm	LOAD CAPACITY kg
C RG DPH25 160	160	204	200



FIXED WHEEL

ORD. NO.	Ø mm	C mm	LOAD CAPACITY kg
C RG BPH25 160	160	204	200

ELASTIC RUBBER



SWIVEL WHEEL WITH BRAKE

ORD. NO.	Ø mm	C mm	LOAD CAPACITY kg
C RG DCE15 160	160	204	300



FIXED WHEEL

ORD. NO.	Ø mm	C mm	LOAD CAPACITY kg
C RG BCE15 160	160	204	300

POLYURETHANE



SWIVEL WHEEL WITH BRAKE

ORD. NO.	Ø mm	C mm	LOAD CAPACITY kg
C RN DDD44 160	160	204	300



FIXED WHEEL

ORD. NO.	Ø mm	C mm	LOAD CAPACITY kg
C RN BDD44 160	160	204	300

KEY



Follow the formula to calculate the load capacity of the trolley:
 $(A \times 3) - 60 \text{ kg}$
 A = load capacity of the wheel
 60 kg = average weight of the trolley

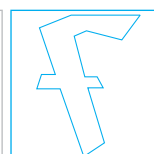
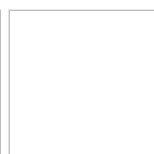
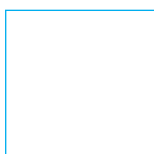

CABINETS SERIES NC-PERFORM

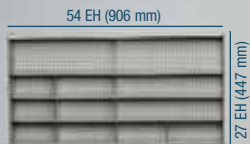

ORD. NO. F AA 1400 19 08
RAL 7035



ORD. NO. F AA 1800 08 08
RAL 7035

■ The max. height of the tool holder taper which can be inserted in the drawer frame is **143 mm**. For higher tapers, please see page **B28**.

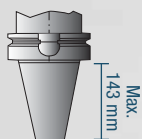

■ Frames ORD. NO. **F NC 5160 00 04** are height-adjustable and can be assembled horizontally or angled.

FLOOR FIXING SET



2x

- 2 "HILTI" plugs for concrete floors \geq to classes B25/RBK250/MPA 25 N/mm²
- Recommended traction of the plug: 2.9 KN
- Plug diameter: \varnothing 6 mm

ORD. NO. F AG 9204 00 99

CABINET WITH LEAF DOORS

ORD. NO.	DRAWERS
F AA 1400 19 08	2
Including 2 drawers (100 kg)	
2 tool holder frames for drawers	
1 height adjustable tool holder frame	
2 height adjustable galvanised shelves (100 kg)	
Dimensions mm 1023x555x2000 h	
Tools and tool holders excluded	

ROLLER SHUTTER CABINET

ORD. NO.
F AA 1800 08 08
Including 4 height adjustable tool holder frames
Dimensions mm 1023x555x2200 h
Tools and tool holders excluded

RAL 7000 F... ..01 RAL 6011 F... ..02 RAL 5012 F... ..04 RAL 7035 F... ..08

SUPPLEMENTARY PARTS ■

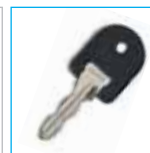
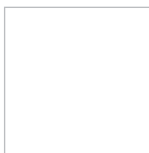
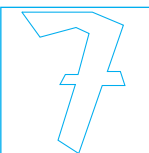

- **Spare key.** Always indicate the number on the cylinder lock of the key to be replaced.
ORD. NO. R CSC 0002 00
- **Master key.** This type of key opens all the 45 and 46 series locks.
ORD. NO. R CSC 0001 00



LENGTH = 1023 mm DEPTH = 555 mm (54x27 Eh)

CABINETS SERIES NC-PERFORM



ORD. NO.

F AA 1401 01 04

Including: 2 frames 3-rows with carriers ORD. NO. **F NC 5160 00 04**
2 frames 3-rows ORD. NO. **F NC 5140 00 01**
2 pair of carriers ORD. NO. **F NC 5630 00 01**
2 telescopic extension drawers ORD. NO. **F AC 1250 00 04**
Dimensions mm 1023x555x2000 h Tool holders excluded

ORD. NO.

F AA 1401 02 04

Including: 4 frames 3-rows with carriers ORD. NO. **F NC 5160 00 04**
Dimensions mm 1023x555x2000 h
Tool holders excluded



ORD. NO.
TOOL HOLDERS

TOOL HOLDER TYPE	MAX. QUANTITY PER TOOL FRAME F NC 5160 00 ..	MAX. QUANTITY PER TOOL FRAME F NC 5140 00 ..
------------------	--	--

F NC 9510 00 03	ISO 30	36	33
F NC 9530 00 03	ISO 40	36	33
F NC 9540 00 03	ISO 45	30	27
F NC 9550 00 03	ISO 50	24	24
F NC 9560 00 03	VDI 30	36	33
F NC 9570 00 03	VDI 40	30	27
F NC 9580 00 03	VDI 50	30	27
F NC 9590 00 03	VDI 60	24	24
F NC 9720 00 03	MORSE TAPER 2	36	33
F NC 9730 00 03	MORSE TAPER 3	36	33
F NC 9740 00 03	MORSE TAPER 4	36	33
F NC 9750 00 03	MORSE TAPER 5	30	27
F NC 9270 00 03	CAPTO C3	36	33
F NC 9275 00 03	CAPTO C4	30	27
F NC 9280 00 03	CAPTO C5	30	27

ORD. NO.
TOOL HOLDERS

TIPO TOOL HOLDER	MAX. QUANTITY PER TOOL FRAME F NC 5160 00 ..	MAX. QUANTITY PER TOOL FRAME F NC 5140 00 ..
------------------	--	--

F NC 9285 00 03	CAPTO C6	30	27
F NC 9290 00 03	CAPTO C8	24	21
F NC 9210 00 03	HSK A32-B40	36	33
F NC 9220 00 03	HSK A40-B50	36	33
F NC 9230 00 03	HSK A50-B63	30	27
F NC 9240 00 03	HSK A63-B80	30	27
F NC 9250 00 03	HSK A80-B100	24	21
F NC 9260 00 03	HSK A100-B125	24	21
F NC 9640 00 03	2"	30	27
F NC 9650 00 03	2" 1/4	24	24
F NC 9010 00 03	58 mm	45	42
F NC 9020 00 03	65 mm	42	39
F NC 9030 00 03	75 mm	36	33
F NC 9040 00 03	87 mm	30	27
F NC 9050 00 03	105 mm	24	24

KEY

RAL 7000 F... ..01 RAL 6011 F... ..02 RAL 5012 F... ..04 RAL 7035 F... ..08



- Cabinet load capacity: **800 kg**
- Frame load capacity: **150 kg**
- Drawers load capacity: **100 kg**
- All indicated loads are net and refer to evenly distributed weights.

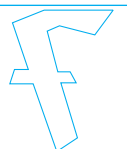

CABINETS SERIES NC-PERFOM



ORD. NO.

F AA 1400 17 04

Including: 2 frames 3-rows with carriers ORD. NO. **F NC 5160 00 04**, 2 frames 3-rows ORD. NO. **F NC 5140 00 01**, 2 pair of carriers ORD. NO. **F NC 5630 00 01**
2 telescopic extension drawers ORD. NO. **F AC 1250 00 04**

Dimensions mm 1023x555x2000 h

Tool holders excluded



ORD. NO.

F AA 1400 18 04

Including: 4 frames 3-rows with carriers ORD. NO. **F NC 5160 00 04**

Dimensions mm 1023x555x2000 h

Tool holders excluded



ORD. NO.

F AA 1402 07 04

Including: 2 frames 3-rows with carriers ORD. NO. **F NC 5160 00 04**, 2 frames 3-rows ORD. NO. **F NC 5140 00 01**, 2 pair of carriers ORD. NO. **F NC 5630 00 01**
2 telescopic extension drawers ORD. NO. **F AC 1250 00 04**

Dimensions mm 1023x555x2000 h

Tool holders excluded

■ 3 mm thickness polycarbonate doors



ORD. NO.

F AA 1402 08 04

Including: 4 frames 3-rows with carriers ORD. NO. **F NC 5160 00 04**

Dimensions mm 1023x555x2000 h

Tool holders excluded

LENGTH = 1023 mm DEPTH = 555 mm (54x27 Eh)

CABINETS SERIES NC-PERFORM



■ RAL 7035

CABINET WITH LEAF DOORS

ORD. NO.	DRAWERS
F AA 1400 19 08	2
Including 2 drawers (100 kg)	
2 tool holder frames for drawers	
1 height adjustable tool holder frame	
2 height adjustable galvanised shelves (100 kg)	
Dimensions mm 1023x555x2000 h	
Tools, tool holders and toolboxes excluded	



■ RAL 7035

ROLLER SHUTTER CABINET

ORD. NO.
F AA 1800 09 08
Including 2 height adjustable tool holder frames
2 height adjustable galvanised shelves (100 kg)
Dimensions mm 1023x555x2200 h
Tools, tool holders and toolboxes excluded

■ KEY

RAL 7000 F... ..01 RAL 6011 F... ..02 RAL 5012 F... ..04 RAL 7035 F... ..08



- Cabinet load capacity: **800 kg**
- Frame load capacity: **150 kg**
- Drawers load capacity: **100 kg**
- All indicated loads are net and refer to evenly distributed weights
- The cabinets must be secured to the floor or to the wall



■ Detail of roller shutter door

■ Partitioning material see page B29

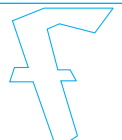

CABINETS SERIES NC-PERFOM



SLIDING DOORS CABINET

ORD. NO.

F AB 8302 05 04

Including:

4 frames 3-rows with carriers ORD. NO. **F NC 5160 00 04**4 frames 3-rows ORD. NO. **F NC 5140 00 01**4 pair of carriers ORD. NO. **F NC 5630 00 01**4 telescopic extension drawers ORD. NO. **F AC 1250 00 04****Dimensions mm 2046x600x2000 h**

Tool holders excluded

- 4 mm thickness polycarbonate doors



SLIDING DOORS CABINET

ORD. NO.

F AB 8300 12 04

Including:

4 frames 3-rows with carriers ORD. NO. **F NC 5160 00 04**4 frames 3-rows ORD. NO. **F NC 5140 00 01**4 pair of carriers ORD. NO. **F NC 5630 00 01**4 telescopic extension drawers ORD. NO. **F AC 1250 00 04****Dimensions mm 2046x600x2000 h**

Tool holders excluded

RAL 7000 F.01 RAL 6011 F.02 RAL 5012 F.04 RAL 7035 F.08

KEY ■



■ Partitioning material see page B29

- Cabinet load capacity: **800 kg** per compartment
- Frame load capacity: **150 kg**
- Drawers load capacity: **100 kg**
- All indicated loads are net and refer to evenly distributed weights
- The cabinets must be secured to the floor or to the wall



LENGTH = 1023 mm DEPTH = 555 mm (54x27 Eh)

CABINETS SERIES NC-PERFORM

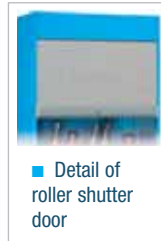

■ Detail of roller shutter door



ORD. NO.

F AA 1800 07 04

Including: 2 frames 3-rows with carriers ORD. NO. **F NC 5160 00 04**, 2 frames 3-rows ORD. NO. **F NC 5140 00 01**, 2 pair of carriers ORD. NO. **F NC 5630 00 01**
2 telescopic extension drawers ORD. NO. **F AC 1250 00 04**

Dimensions mm 1023x555x2200 h

Tool holders excluded

ORD. NO.

F AA 1800 08 04

Including: 4 frames 3-rows with carriers ORD. NO. **F NC 5160 00 04**

Dimensions mm 1023x555x2200 h

Tool holders excluded



ORD. NO.
TOOL HOLDERS

TOOL HOLDER
TYPE

MAX. QUANTITY
PER TOOL FRAME
F NC 5160 00 ..

MAX. QUANTITY
PER TOOL FRAME
F NC 5140 00 ..

ORD. NO. TOOL HOLDERS	TOOL HOLDER TYPE	MAX. QUANTITY PER TOOL FRAME F NC 5160 00 ..	MAX. QUANTITY PER TOOL FRAME F NC 5140 00 ..
F NC 9510 00 03	ISO 30	36	33
F NC 9530 00 03	ISO 40	36	33
F NC 9540 00 03	ISO 45	30	27
F NC 9550 00 03	ISO 50	24	24
F NC 9560 00 03	VDI 30	36	33
F NC 9570 00 03	VDI 40	30	27
F NC 9580 00 03	VDI 50	30	27
F NC 9590 00 03	VDI 60	24	24
F NC 9720 00 03	MORSE TAPER 2	36	33
F NC 9730 00 03	MORSE TAPER 3	36	33
F NC 9740 00 03	MORSE TAPER 4	36	33
F NC 9750 00 03	MORSE TAPER 5	30	27
F NC 9270 00 03	CAPTO C3	36	33
F NC 9275 00 03	CAPTO C4	30	27
F NC 9280 00 03	CAPTO C5	30	27

ORD. NO.
TOOL HOLDERS

TOOL HOLDER
TYPE

MAX. QUANTITY
PER TOOL FRAME
F NC 5160 00 ..

MAX. QUANTITY
PER TOOL FRAME
F NC 5140 00 ..

ORD. NO. TOOL HOLDERS	TOOL HOLDER TYPE	MAX. QUANTITY PER TOOL FRAME F NC 5160 00 ..	MAX. QUANTITY PER TOOL FRAME F NC 5140 00 ..
F NC 9285 00 03	CAPTO C6	30	27
F NC 9290 00 03	CAPTO C8	24	21
F NC 9210 00 03	HSK A32-B40	36	33
F NC 9220 00 03	HSK A40-B50	36	33
F NC 9230 00 03	HSK A50-B63	30	27
F NC 9240 00 03	HSK A63-B80	30	27
F NC 9250 00 03	HSK A80-B100	24	21
F NC 9260 00 03	HSK A100-B125	24	21
F NC 9640 00 03	2"	30	27
F NC 9650 00 03	2" 1/4	24	24
F NC 9010 00 03	58 mm	45	42
F NC 9020 00 03	65 mm	42	39
F NC 9030 00 03	75 mm	36	33
F NC 9040 00 03	87 mm	30	27
F NC 9050 00 03	105 mm	24	24

KEY

RAL 7000 F... ..01 RAL 6011 F... ..02 RAL 5012 F... ..04 RAL 7035 F... ..08



- Cabinet load capacity: **800 kg**
- Frame load capacity: **150 kg**
- Drawers load capacity: **100 kg**
- All indicated loads are net and refer to evenly distributed weights
- The cabinets must be secured to the floor or to the wall



■ Detail of roller shutter door

■ Partitioning material see page **B29**

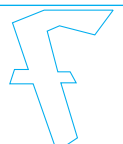

CABINETS SERIES NC-PERFORM

EMPTY CABINET WITH DOORS

- 01
- 02
- 04
- 08



ORD. NO.

F AA 1400 00 04

Cabinet load capacity: 800 kg

Dimensions mm 1023x555x2000 h

Internal dimensions mm 995x500x1850 h

The cabinet series F AA 1400 is standard supplied with 2 floor fixing brackets and 2 wall fixing brackets.

EMPTY CABINET WITH DOORS WITH PERFORATED PANELS

- 01
- 02
- 04
- 08



ORD. NO.

F AA 1403 00 04

Cabinet load capacity: 800 kg

Load capacity of each individual door: 40 kg

Dimensions mm 1023x555x2000 h

Internal dimensions mm 995x500x1850 h

The cabinet series F AA 1403 is standard supplied with 2 floor fixing brackets and 2 wall fixing brackets.

EMPTY CABINET WITH PAIR OF 3 mm THICKNESS POLYCARBONATE DOORS

- 01
- 02
- 04
- 08



ORD. NO.

F AA 1402 00 04

Cabinet load capacity: 800 kg

Dimensions mm 1023x555x2000 h

Internal dimensions mm 995x500x1850 h

The cabinet series F AA 1402 is standard supplied with 2 floor fixing brackets and 2 wall fixing brackets.

EMPTY CABINET WITHOUT DOOR

- 01
- 02
- 04
- 08



ORD. NO.

F AA 1401 00 04

Cabinet load capacity: 800 kg

Dimensions mm 1023x555x2000 h

Internal dimensions mm 995x500x1850 h

The cabinet series F AA 1401 is standard supplied with 2 floor fixing brackets and 2 wall fixing brackets.

EMPTY CABINET WITH ROLLER SHUTTER DOOR

- 01
- 02
- 04
- 08



ORD. NO.

F AA 1800 00 04

Cabinet load capacity: 800 kg

Dimensions mm 1023x555x2200 h

Internal dimensions mm 995x500x1820 h

The cabinet series F AA 1800 is standard supplied with 2 floor fixing brackets and 2 wall fixing brackets.

EMPTY CABINET WITH POLYCARB. DOORS 4 mm THICKNESS AND CENTRE SUPPORT

- 01
- 02
- 04
- 08



ORD. NO.

F AB 8302 00 04

Cabinet load capacity: 800 kg per compartment

Dimensions mm 2046x600x2000 h

Internal dim. of each compart. mm 995x500x1850 h

The cabinet series F AB 8302 is standard supplied with 4 floor fixing brackets and 4 wall fixing brackets.

■ **The cabinet must be secured to the floor or wall.** If one or more drawers are fitted, the cabinets must be secured to the floor or to the wall (if the drawers are fitted at a height over 1000 mm from the floor, the cabinet must be secured to the wall only). **The cabinet with doors with perforated panels must be fixed to the wall.**



■ Each drawer introduced into the cabinet compartments has a maximum load capacity of 350 kg regardless of the load capacity of the cabinet

- 01
- 02
- 04
- 08



EMPTY CABINET WITH DOORS AND CENTRE SUPPORT

ORD. NO.

F AB 8300 00 04

Cabinet load capacity: 800 kg per compartment

Dimensions mm 2046x600x2000 h

Internal dim. of each compart. mm 995x500x1850 h

The cabinet series F AB 8300 is standard supplied with 4 floor fixing brackets and 4 wall fixing brackets.

LENGTH = 1023/2046 mm DEPTH = 555/600 mm (54x27 Eh)

CABINETS SERIES NC-PERFORM

PAIR OF NORMAL OR TELESCOPIC EXTENSION DRAWERS 24x27 EH

ORD. NO.	EXTENSION
F AC 1600 00 04	NORMAL
F AC 1650 00 04	TELESCOPIC

Load capacity of each normal extension drawer: 50 kg

Load capacity of each telescopic extension drawer: 60 kg

Internal dimensions mm 396x447x85 h (for drawer)

01
02
04

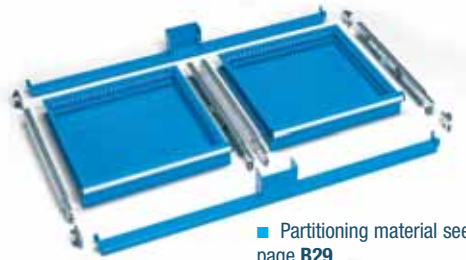

■ Partitioning material see page B29

NORMAL OR TELESCOPIC EXTENSION DRAWERS 54x27 EH

ORD. NO.	EXTENSION
F AC 1200 00 04	NORMAL
F AC 1250 00 04	TELESCOPIC

Load capacity of normal extension drawer: 50 kg

Load capacity of telescopic extension drawer: 100 kg

Internal dimensions mm 906x447x85 h

01
02
04



FULL EXTENSION SUSPENSION FOLDER FRAME FOR SUSPENSION FOLDER DIN A4

ORD. NO.
F AC 7500 00 07

The suspension folder frames are supplied with full extension guide rails (100% extraction) with 30 kg load capacity

Overall dimensions: 990x500 mm

For suspension folder DIN A4



07

ADJUSTABLE SHELF DEPTH 500 mm



99

ORD. NO.	DIM. mm	Q.TY STRENG. BAR	LOAD CAPACITY kg
F AC 2500 01 99	995x500x35 h	0	100
F AC 2500 03 99	995x500x35 h	1	180

Including 4 hooks

The depth of this shelf is suitable for the following containers:
size 4A2 / size 4 / size 4A5



size 4A2



size 4



size 4A5



■ This type of shelf can be assembled only if the perforated back panel is not fitted.

■ Contenitori vedi pag. G28 – G30



CABINETS SERIES NC-PERFORM

TOOL HOLDER FRAMES 3-ROWS FOR DRAWERS



■ 01
■ 02

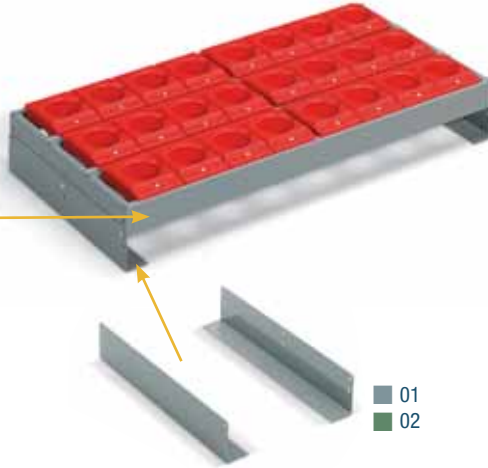

■ 01
■ 02

■ The tool holder frame load capacity is given by the drawer load capacity.

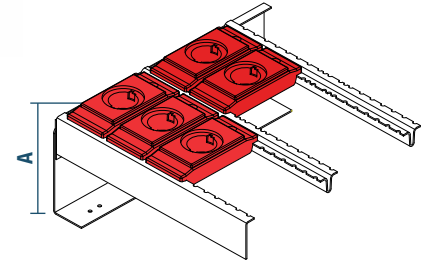

ORD. NO.

F NC 5140 00 01

Overall dim. mm 890x444x69 h

PAIR OF CARRIERS

ORD. NO.

DIMENSIONS mm

FOR LENGTH TAPERS mm REF. A

F NC 5630 00 01

446x86 h

A = 93 / 118 / 143

F NC 5830 00 01

446x136 h

A = 143 / 168 / 193

ORD. NO. TOOL HOLDERS



TOOL HOLDER TYPE

MAX. QUANTITY PER TOOL FRAME F NC 5140 00..

F NC 9510 00 03	ISO 30	33
F NC 9530 00 03	ISO 40	33
F NC 9540 00 03	ISO 45	27
F NC 9550 00 03	ISO 50	24
F NC 9560 00 03	VDI 30	33
F NC 9570 00 03	VDI 40	27
F NC 9580 00 03	VDI 50	27
F NC 9590 00 03	VDI 60	24
F NC 9720 00 03	MORSE TAPER 2	33
F NC 9730 00 03	MORSE TAPER 3	33

ORD. NO. TOOL HOLDERS



TOOL HOLDER TYPE

MAX. QUANTITY PER TOOL FRAME F NC 5140 00..

F NC 9740 00 03	MORSE TAPER 4	33
F NC 9750 00 03	MORSE TAPER 5	27
F NC 9270 00 03	CAPTO C3	33
F NC 9275 00 03	CAPTO C4	27
F NC 9280 00 03	CAPTO C5	27
F NC 9285 00 03	CAPTO C6	27
F NC 9290 00 03	CAPTO C8	21
F NC 9210 00 03	HSK A32-B40	33
F NC 9220 00 03	HSK A40-B50	33
F NC 9230 00 03	HSK A50-B63	27

ORD. NO. TOOL HOLDERS



TOOL HOLDER TYPE

MAX. QUANTITY PER TOOL FRAME F NC 5140 00..

F NC 9240 00 03	HSK A63-B80	27
F NC 9250 00 03	HSK A80-B100	21
F NC 9260 00 03	HSK A100-B125	21
F NC 9640 00 03	2"	27
F NC 9650 00 03	2" 1/4	24
F NC 9010 00 03	58 mm	42
F NC 9020 00 03	65 mm	39
F NC 9030 00 03	75 mm	33
F NC 9040 00 03	87 mm	27
F NC 9050 00 03	105 mm	24

TILTING TOOL HOLDER FRAMES WITH 3 ROWS FOR CABINET

■ 01 ■ 02 ■ 04



TOOL HOLDER FRAME 3-ROWS

ORD. NO.

F NC 5160 00 01

Horizontal frame load capacity: 150 kg

Overall dimensions mm 965x500x69



ORD. NO. TOOL HOLDERS



TOOL HOLDER TYPE

MAX. QUANTITY PER TOOL FRAME F NC 5160 00..

F NC 9510 00 03	ISO 30	36
F NC 9530 00 03	ISO 40	36
F NC 9540 00 03	ISO 45	30
F NC 9550 00 03	ISO 50	24
F NC 9560 00 03	VDI 30	36
F NC 9570 00 03	VDI 40	30
F NC 9580 00 03	VDI 50	30
F NC 9590 00 03	VDI 60	24
F NC 9720 00 03	MORSE TAPER 2	36
F NC 9730 00 03	MORSE TAPER 3	36

ORD. NO. TOOL HOLDERS



TOOL HOLDER TYPE

MAX. QUANTITY PER TOOL FRAME F NC 5160 00..

F NC 9740 00 03	MORSE TAPER 4	36
F NC 9750 00 03	MORSE TAPER 5	30
F NC 9270 00 03	CAPTO C3	36
F NC 9275 00 03	CAPTO C4	30
F NC 9280 00 03	CAPTO C5	30
F NC 9285 00 03	CAPTO C6	30
F NC 9290 00 03	CAPTO C8	24
F NC 9210 00 03	HSK A32-B40	36
F NC 9220 00 03	HSK A40-B50	36
F NC 9230 00 03	HSK A50-B63	30

ORD. NO. TOOL HOLDERS



TOOL HOLDER TYPE

MAX. QUANTITY PER TOOL FRAME F NC 5160 00..

F NC 9240 00 03	HSK A63-B80	30
F NC 9250 00 03	HSK A80-B100	24
F NC 9260 00 03	HSK A100-B125	24
F NC 9640 00 03	2"	30
F NC 9650 00 03	2" 1/4	24
F NC 9010 00 03	58 mm	45
F NC 9020 00 03	65 mm	42
F NC 9030 00 03	75 mm	36
F NC 9040 00 03	87 mm	30
F NC 9050 00 03	105 mm	24

24x27 EH / 54x27 EH

CABINETS SERIES NC-PERFORM

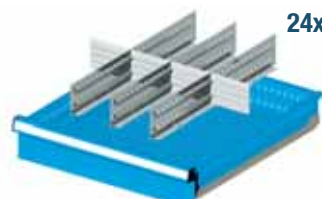
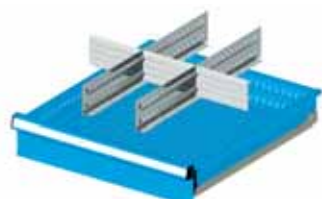
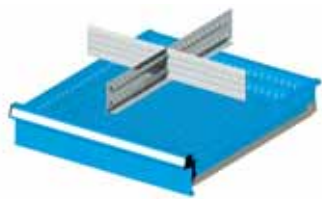

24x27 EH

ORD. NO. FOR FRONT HEIGHTS

F FH 0050 01 00 100

Set including:	
1 Slotted partition	455 mm
2 Plain partitions	200 mm

ORD. NO. FOR FRONT HEIGHTS

F FH 0050 02 00 100

Set including:	
2 Slotted partitions	455 mm
3 Plain partitions	132 mm

ORD. NO. FOR FRONT HEIGHTS

F FH 0050 03 00 100

Set including:	
3 Slotted partitions	455 mm
4 Plain partitions	98 mm

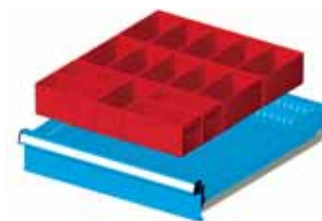
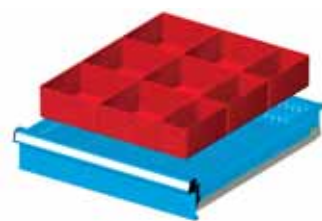
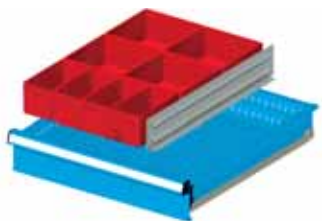

ORD. NO. FOR FRONT HEIGHTS

F FH 0050 07 00 100

Set including:	
1 Slotted partition	455 mm
4 Plastic boxes	150x75 mm
4 Plastic boxes	150x150 mm

ORD. NO. FOR FRONT HEIGHTS

F FH 0050 08 00 100

Set including:	
3 Plastic boxes	150x75 mm
6 Plastic boxes	150x150 mm

ORD. NO. FOR FRONT HEIGHTS

F FH 0050 09 00 100

Set including:	
15 Plastic boxes	150x75 mm

■ Partitioning material see page A180

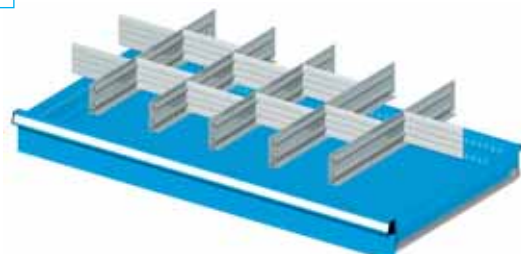
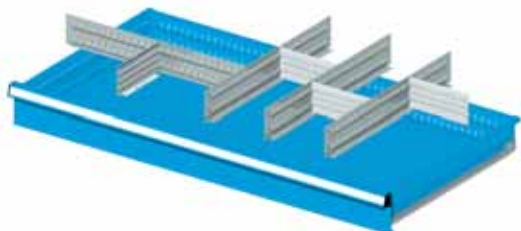

54x27 EH

ORD. NO. FOR FRONT HEIGHTS

F FH 0200 01 00 100

Set including:	
4 Slotted partitions	455 mm
4 Plain partitions	149 mm

ORD. NO. FOR FRONT HEIGHTS

F FH 0200 02 00 100

Set including:	
5 Slotted partitions	455 mm
10 Plain partitions	149 mm

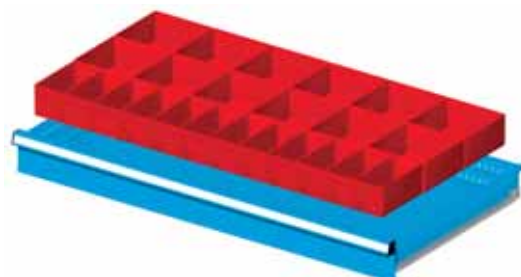
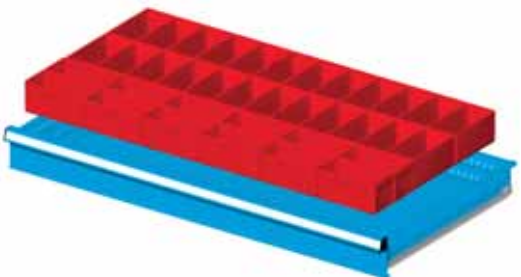

ORD. NO. FOR FRONT HEIGHTS

F FH 0200 05 00 100

Set including:	
36 Plastic boxes	150x75 mm

ORD. NO. FOR FRONT HEIGHTS

F FH 0200 06 00 100

Set including:	
12 Plastic boxes	150x75 mm
12 Plastic boxes	150x150 mm



ORD. NO. F NC 0822 12 51
RAL 5012+7000



ORD. NO. F NC 0211 01 51
RAL 5012+7000

FIXING SET



■ Fixing material including (for 1 upright frame) 2 steel floor bolts M8x75 mm for uninterrupted concrete floors equal to higher than class: B25 / RBK250 / MPa 25 N for mm².

ORD. NO. F NC 8999 00 99

■ The shelving system must be fixed to the floor or to the wall.

SHELVING SYSTEM WITH ROLLER SHUTTER

ORD. NO.

F NC 0822 12 51

Including 4 telescopic extension drawers with tool holder frame 3-rows and carriers

Dimensions mm 1042x645x2200 h

Tools and tool holders excluded

SHELVING SYSTEM WITH LEAF DOORS

ORD. NO.

F NC 0211 01 51

Including 16 tool holder frames 1-row with angled carriers

Dimensions mm 1290x505x2000 h

Tools and tool holders excluded

RAL 7000 F..01

RAL 6011 F..02

RAL 5012 +
RAL 7000F..51

RAL 7035 +
RAL 7000F..56

SUPPLEMENTARY PARTS ■

■ **Spare key.** Always indicate the number on the cylinder lock of the key to be replaced.

ORD. NO. R CSC 0002 00

■ **Master key.** This type of key opens all the 45 and 46 series locks.

ORD. NO. R CSC 0001 00



SHELVING SYSTEM SERIES NC-SYSTEM



ORD. NO.

F NC 0110 01 51

Including: 8 frames 1-row ORD. NO. **F NC 5020 00 01**

8 pair of angled carriers ORD. NO. **F NC 5711 00 99**

Load capacity of shelving system: 1500 kg

Dimensions mm 660x470x2000 h

Tool holders excluded

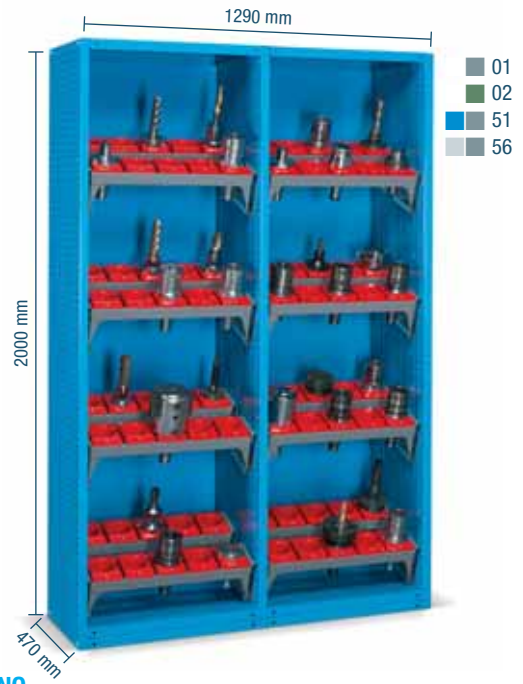

ORD. NO.

F NC 0210 01 51

Including: 16 frames 1-row ORD. NO. **F NC 5020 00 01**

16 pair of angled carriers ORD. NO. **F NC 5711 00 99**

Load capacity of shelving system for compartment: 500 kg

Dimensions mm 1290x470x2000 h

Tool holders excluded



ORD. NO.

F NC 0111 01 51

Including: 8 frames 1-row ORD. NO. **F NC 5020 00 01**

8 pair of angled carriers ORD. NO. **F NC 5711 00 99**

Load capacity of shelving system: 1500 kg

Dimensions mm 660x495x2000 h

Tool holders excluded



ORD. NO.

F NC 0211 01 51

Including: 16 frames 1-row ORD. NO. **F NC 5020 00 01**

16 pair of angled carriers ORD. NO. **F NC 5711 00 99**

Load capacity of shelving system for compartment: 500 kg

Dimensions mm 1290x495x2000 h

Tool holders excluded

KEY

RAL 7000 F... ..01 RAL 6011 F... ..02 RAL 5012 + RAL 7000 F... ..51 RAL 7035 + RAL 7000 F... ..56



- The shelving system must be fixed to the floor or to the wall
- All indicated loads are net and refer to evenly distributed weights

■ Tool holders see page B32

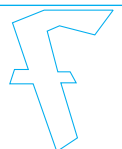

SHELVING SYSTEM SERIES NC-SYSTEM

**ORD. NO.
TOOL HOLDERS**TOOL HOLDER
TYPEMAX. QUANTITY PER
TOOL FRAME F NC 5020 00 ..

F NC 9510 00 03	ISO 30	7
F NC 9530 00 03	ISO 40	7
F NC 9540 00 03	ISO 45	5
F NC 9550 00 03	ISO 50	5
F NC 9560 00 03	VDI 30	7
F NC 9570 00 03	VDI 40	5
F NC 9580 00 03	VDI 50	5
F NC 9590 00 03	VDI 60	5
F NC 9720 00 03	MORSE TAPER 2	7
F NC 9730 00 03	MORSE TAPER 3	7
F NC 9740 00 03	MORSE TAPER 4	7
F NC 9750 00 03	MORSE TAPER 5	5
F NC 9270 00 03	CAPTO C3	7
F NC 9275 00 03	CAPTO C4	5
F NC 9280 00 03	CAPTO C5	5

**ORD. NO.
TOOL HOLDERS**TOOL HOLDER
TYPEMAX. QUANTITY PER
TOOL FRAME F NC 5020 00 ..

F NC 9285 00 03	CAPTO C6	5
F NC 9290 00 03	CAPTO C8	4
F NC 9210 00 03	HSK A32-B40	7
F NC 9220 00 03	HSK A40-B50	7
F NC 9230 00 03	HSK A50-B63	5
F NC 9240 00 03	HSK A63-B80	5
F NC 9250 00 03	HSK A80-B100	4
F NC 9260 00 03	HSK A100-B125	4
F NC 9640 00 03	2"	5
F NC 9650 00 03	2" 1/4	5
F NC 9010 00 03	58 mm	9
F NC 9020 00 03	65 mm	8
F NC 9030 00 03	75 mm	7
F NC 9040 00 03	87 mm	6
F NC 9050 00 03	105 mm	5



RAL 7000 F... ..01

RAL 6011 F... ..02

RAL 5012 F... ..04

RAL 7035 F... ..08

INFO ■

www.famispa.com

SHELVING SYSTEM SERIES NC-SYSTEM

EMPTY SHELVING SYSTEM SERIES F NC 0110 / F NC 0111



ORD. NO.
F NC 0110 00 04
Single shelving system
Load capacity of single shelving system: 1500 kg
Dim. mm 660x470x2000 h

ORD. NO.
F NC 0110 X0 04
Add-on shelving system
Load cap. of single shelving system + add-on: 500 kg for compartment
Dim. mm 630x470x2000 h



ORD. NO.
F NC 0111 00 04
Single shelving system
Load capacity of single shelving system: 1500 kg
Dim. mm 660x495x2000 h

ORD. NO.
F NC 0111 X0 04
Add-on shelving system
Load cap. of single shelving system + add-on: 500 kg for compartment
Dim. mm 630x495x2000 h

ADJUSTABLE SHELF



ORD. NO.
F NC 3200 01 04
LOAD CAPACITY kg: 30
Overall dimensions mm 600x470x30 h

RUBBER MAT



ORD. NO.
F NC 3950 00 07
Overall dimensions mm 595x465

ALUMINIUM INSERT FOR SHELVING SYSTEM F NC 0110 / F NC 0111



ORD. NO.
F NC 2410 00 00
Aluminium insert with rubber
Overall dimensions mm 525x135x45 h



KEY

RAL 7000 F... ..01 RAL 6011 F... ..02 RAL 5012 F... ..04 RAL 7035 F... ..08



- The shelving system must be fixed to the floor or to the wall
- All indicated loads are net and refer to evenly distributed weights



SHELVING SYSTEM SERIES NC-SYSTEM

TOOL FOR WOODEN INSERT OF MULTIPLEX FOR SHELVING SYSTEM F NC 0110 / F NC 0111

■ 01
■ 02



TOOL FOR WOODEN INSERT OF MULTIPLEX
ORD. NO.
F NC 5021 00 01
Horizontal frame load capacity: 50 kg
Overall dimensions mm 584x140x146 h



WOODEN INSERT OF MULTIPLEX
ORD. NO.
F NC 2510 00 00
Overall dimensions mm 525x138x50 h



Example of tool holder frame
ORD. NO. F NC 5021 00 ..

TOOL HOLDER FRAME AND ACCESSORIES FOR SHELVING SYSTEM F NC 0110 / F NC 0111

■ 01
■ 02

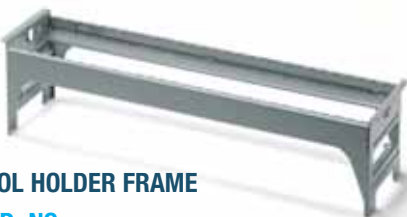

TOOL HOLDER FRAME
ORD. NO.

F NC 5020 00 01
Horizontal frame load capacity: 50 kg
Dimensions mm 584x140x146 h



PAIR OF GALVANISED HANDLES
ORD. NO.

F NC 5005 00 99
For frame ORD. NO. F NC 5020 00 ..



■ 99



PAIR OF GALVANISED HORIZONTAL CARRIERS
ORD. NO.

F NC 5710 00 99
For frame ORD. NO. F NC 5020 00 ..
Overall dimensions mm 140x150 h



■ 99



PAIR OF GALVANISED ANGLED CARRIERS
ORD. NO.

F NC 5711 00 99
For frame ORD. NO. F NC 5020 00 ..
Overall dimensions mm 140x150 h

TOOL HOLDER FRAME 3-ROWS AND ACCESSORIES FOR SHELVING SYSTEM F NC 0110 / F NC 0111



■ 01
■ 02

TOOL HOLDER FRAME 3-ROWS
ORD. NO.

F NC 5120 00 01
Horizontal frame load capacity: 150 kg
Overall dimensions mm 584x444x69 h



■ 01
■ 02

HORIZONTAL PAIR OF CARRIERS
ORD. NO.

F NC 5620 00 01
For frame ORD. NO. F NC 5120 00 ..
Overall dimensions mm 430x112 h



■ 01
■ 02

ANGLED PAIR OF CARRIERS
ORD. NO.

F NC 5721 00 01
For frame ORD. NO. F NC 5120 00 ..
Overall dimensions mm 430x114 h

RAL 7000 F... ..01 RAL 6011 F... ..02

KEY ■

■ All indicated loads are net and refer to evenly distributed weights



SHELVING SYSTEM SERIES NC-SYSTEM



**ORD. NO.
TOOL HOLDERS**

TOOL HOLDER TYPE	MAX. QUANTITY PER TOOL FRAME F NC 5020 00 ..	MAX. QUANTITY PER TOOL FRAME F NC 5120 00 ..
------------------	--	--

F NC 9510 00 03	ISO 30	7	24
F NC 9530 00 03	ISO 40	7	24
F NC 9540 00 03	ISO 45	5	18
F NC 9550 00 03	ISO 50	5	15
F NC 9560 00 03	VDI 30	7	24
F NC 9570 00 03	VDI 40	5	18
F NC 9580 00 03	VDI 50	5	18
F NC 9590 00 03	VDI 60	5	15
F NC 9720 00 03	MORSE TAPER 2	7	24
F NC 9730 00 03	MORSE TAPER 3	7	24
F NC 9740 00 03	MORSE TAPER 4	7	24
F NC 9750 00 03	MORSE TAPER 5	5	18
F NC 9270 00 03	CAPTO C3	7	24
F NC 9275 00 03	CAPTO C4	5	18
F NC 9280 00 03	CAPTO C5	5	18

**ORD. NO.
TOOL HOLDERS**

TOOL HOLDER TYPE	MAX. QUANTITY PER TOOL FRAME F NC 5020 00 ..	MAX. QUANTITY PER TOOL FRAME F NC 5120 00 ..
------------------	--	--

F NC 9285 00 03	CAPTO C6	5	18
F NC 9290 00 03	CAPTO C8	4	12
F NC 9210 00 03	HSK A32-B40	7	24
F NC 9220 00 03	HSK A40-B50	7	24
F NC 9230 00 03	HSK A50-B63	5	18
F NC 9240 00 03	HSK A63-B80	5	18
F NC 9250 00 03	HSK A80-B100	4	12
F NC 9260 00 03	HSK A100-B125	4	12
F NC 9640 00 03	2"	5	18
F NC 9650 00 03	2" 1/4	5	15
F NC 9010 00 03	58 mm	9	27
F NC 9020 00 03	65 mm	8	24
F NC 9030 00 03	75 mm	7	21
F NC 9040 00 03	87 mm	6	18
F NC 9050 00 03	105 mm	5	15



■ INFO



www.famispa.com

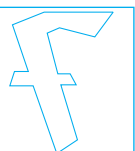

SHELVING SYSTEM SERIES NC-SYSTEM



ORD. NO.

F NC 0120 01 51

Including:

3 frames 4-rows ORD. NO. **F NC 5220 00 01**

3 pair of carriers ORD. NO. **F NC 5741 00 01**

Load capacity of shelving system: 1500 kg

Dimensions mm 660x620x2000 h

Tool holders excluded



ORD. NO.

F NC 0220 01 51

DRAWERS

2

Including: 18 frames 1-row ORD. NO. **F NC 5020 00 01**

18 pair of angled carriers ORD. NO. **F NC 5711 00 99**

2 adjustable shelves ORD. NO. **F NC 3210 00 04**

2 telescopic extension drawers ORD. NO. **F NC 8610 00 04**

Load capacity of shelving system for compartment: 500 kg

Dimensions mm 1290x620x2000 h

Tool holders excluded



ORD. NO.

F NC 0121 01 51

Including: 9 frames 1-row ORD. NO. **F NC 5020 00 01**

9 pair of angled carriers ORD. NO. **F NC 5711 00 99**

Load capacity of shelving system: 1500 kg

Dimensions mm 660x645x2000 h

Tool holders excluded



ORD. NO.

F NC 0221 01 51

Including: 18 frames 1-row ORD. NO. **F NC 5020 00 01**

18 pair of angled carriers ORD. NO. **F NC 5711 00 99**

Load capacity of shelving system for compartment: 500 kg

Dimensions mm 1290x645x2000 h

Tool holders excluded

RAL 7000 F... ..01 RAL 6011 F... ..02 RAL 5012 RAL 7035 RAL 7000 F... ..51 RAL 7000 F... ..56

KEY ■

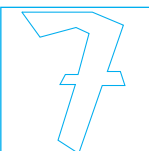

■ Partitioning material see page B47

- The shelving system must be fixed to the floor or to the wall
- All indicated loads are net and refer to evenly distributed weights



SHELVING SYSTEM SERIES NC-SYSTEM

EMPTY SHELVING SYSTEM SERIES F NC 0120 / F NC 0121



- 01
- 02
- 04
- 08

- 01
- 02
- 04
- 08



- 01
- 02
- 04
- 08

- 01
- 02
- 04
- 08

ORD. NO.

F NC 0120 00 04

Single shelving system

Load capacity of single shelving system: 1500 kg

Dim. mm 660x620x2000 h

ORD. NO.

F NC 0120 X0 04

Add-on shelving system

Load capacity of single shelving system + add-on: 500 kg for compartment

Dim. mm 630x620x2000 h

ORD. NO.

F NC 0121 00 04

Single shelving system with door

Load capacity of single shelving system: 1500 kg

Dim. mm 660x645x2000 h

ORD. NO.

F NC 0121 X0 04

Add-on shelving system with door

Load capacity of single shelving system+add-on: 500 kg for comp.

Dim. mm 630x645x2000 h

ADJUSTABLE SHELF



- 01
- 02
- 04

ORD. NO.

F NC 3210 01 04

Overall dimensions mm 600x620x30 h

LOAD CAPACITY kg

30

RUBBER MAT



- 07

ORD. NO.

F NC 3955 00 07

Overall dimensions mm 595x615

FIXING SET



■ Fixing material including (for 1 upright frame) 2 steel floor bolts M8x75 mm for uninterrupted concrete floors equal to higher than class: B25 / RBK250 / MPA 25 N for mm².

ORD. NO. **F NC 8999 00 99**

■ The shelving system must be fixed to the floor or to the wall.

ALUMINIUM INSERT FOR SHELVING SYSTEM F NC 0120 / F NC 0121



ORD. NO.

F NC 2410 00 00

Aluminium insert with rubber

Overall dimensions mm 525x135x45 h



Example of tool holder frame ORD. NO. **F NC 5020 00 ..** with aluminium support

KEY

RAL 7000 F... ..01 RAL 6011 F... ..02 RAL 5012 F... ..04 RAL 7035 F... ..08



- The shelving system must be fixed to the floor or to the wall
- All indicated loads are net and refer to evenly distributed weights



SHELVING SYSTEM SERIES NC-SYSTEM

TOOL HOLDER FRAMES 3-ROWS FOR DRAWERS FOR SHELVING SYSTEM F NC 0120 / F NC 0121

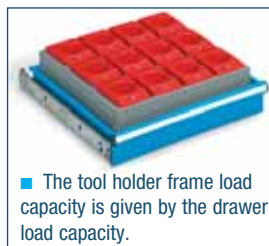
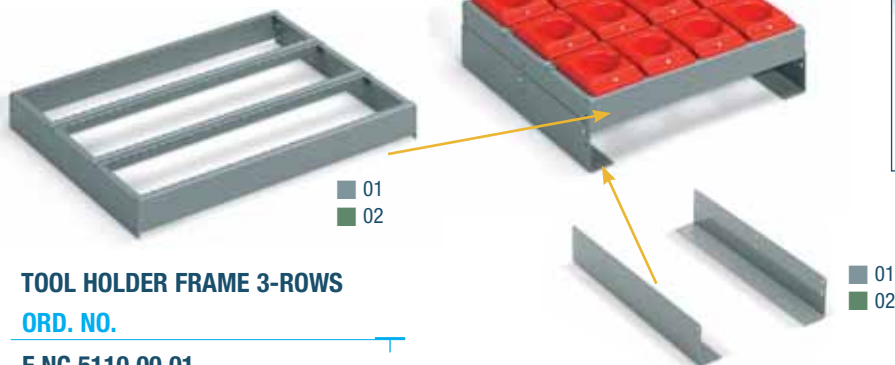

Example of drawer application with tool holder frame 3-rows
ORD. NO. **F NC 8610 00 04**
1 pair of carriers
ORD. NO. **F NC 5110 00 01**
and 12 tool holders ISO 50.

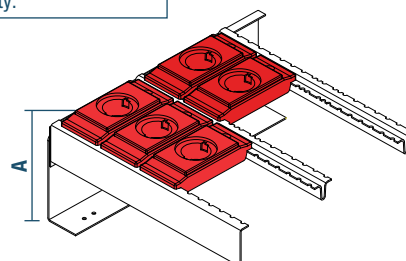

TOOL HOLDER FRAME 3-ROWS

ORD. NO.

F NC 5110 00 01

Overall dimensions mm 515x444x69 h

PAIR OF CARRIERS

ORD. NO.

DIMENSIONS mm

FOR LENGTH TAPERS MM REF. A

F NC 5630 00 01

446x86 h

A = 93 / 118 / 143

F NC 5830 00 01

446x136 h

A = 143 / 168 / 193

ORD. NO.
TOOL HOLDERS

TOOL HOLDER
TYPE

MAX. QUANTITY
PER TOOL FRAME
F NC 5110 00..

F NC 9510 00 03	ISO 30	21
F NC 9530 00 03	ISO 40	21
F NC 9540 00 03	ISO 45	15
F NC 9550 00 03	ISO 50	12
F NC 9560 00 03	VDI 30	21
F NC 9570 00 03	VDI 40	15
F NC 9580 00 03	VDI 50	15
F NC 9590 00 03	VDI 60	12
F NC 9720 00 03	MORSE TAPER 2	21
F NC 9730 00 03	MORSE TAPER 3	21

ORD. NO.
TOOL HOLDERS

TOOL HOLDER
TYPE

MAX. QUANTITY
PER TOOL FRAME
F NC 5110 00..

F NC 9740 00 03	MORSE TAPER 4	21
F NC 9750 00 03	MORSE TAPER 5	15
F NC 9270 00 03	CAPTO C3	21
F NC 9275 00 03	CAPTO C4	15
F NC 9280 00 03	CAPTO C5	15
F NC 9285 00 03	CAPTO C6	15
F NC 9290 00 03	CAPTO C8	12
F NC 9210 00 03	HSK A32-B40	21
F NC 9220 00 03	HSK A40-B50	21
F NC 9230 00 03	HSK A50-B63	15

ORD. NO.
TOOL HOLDERS

TOOL HOLDER
TYPE

MAX. QUANTITY
PER TOOL FRAME
F NC 5110 00..

F NC 9240 00 03	HSK A63-B80	15
F NC 9250 00 03	HSK A80-B100	12
F NC 9260 00 03	HSK A100-B125	12
F NC 9640 00 03	2"	15
F NC 9650 00 03	2" 1/4	12
F NC 9010 00 03	58 mm	24
F NC 9020 00 03	65 mm	21
F NC 9030 00 03	75 mm	18
F NC 9040 00 03	87 mm	15
F NC 9050 00 03	105 mm	12

31,5x27 EH FULL TELESCOPIC EXTENSION DRAWERS FOR SHELVING SYSTEM F NC 0120 / F NC 0121



ORD. NO.

USABLE DIM.
mm

FRONT
HEIGHT mm

LOAD CAPACITY
kg

F NC 8607 00 04

523x447x54 h

75

150

F NC 8610 00 04

523x447x79 h

100

150

F NC 8615 00 04

523x447x129 h

150

150

Extension: 100%

In the tool storage shelving system series **F NC 0120 / 121 / 220 / 221** drawers have to be assembled from the bottom to the top till a max. height of 1000 mm, paying attention that the load capacity of one drawer is 150 kg and that the total weight in all the drawers do not exceed 400 kg per compartment.



Drawers including the single drawer opening device.

Partitioning material see page **B47**

TOOL FOR WOODEN INSERT OF MULTIPLEX FOR SHELVING SYSTEM F NC 0120 / F NC 0121



TOOL FOR WOODEN INSERT OF MULTIPLEX

ORD. NO. **F NC 5021 00 01**

Horizontal frame load capacity: 50 kg

Overall dimensions mm 584x140x146 h



WOODEN INSERT OF MULTIPLEX

ORD. NO. **F NC 2510 00 00**

Overall dimensions mm 525x138x50 h



Example of tool holder frame
ORD. NO. **F NC 5021 00 ..**

SHELVING SYSTEM SERIES NC-SYSTEM

TOOL HOLDER FRAME AND ACCESSORIES FOR SHELVING SYSTEM F NC 0120 / F NC 0121



TOOL HOLDER FRAME

ORD. NO. F NC 5020 00 01

Horizontal frame load capacity: 50 kg

Dimensions mm 584x140x146 h



PAIR OF GALVANISED HANDLES

ORD. NO. F NC 5005 00 99

For frame ORD. NO. F NC 5020 00 ..



PAIR OF GALVANISED HORIZONTAL CARRIERS

ORD. NO. F NC 5710 00 99

For frame ORD. NO. F NC 5020 00 ..

Overall dimensions mm 140x150 h



PAIR OF GALVANISED ANGLED CARRIERS

ORD. NO. F NC 5711 00 99

For frame ORD. NO. F NC 5020 00 ..

Overall dimensions mm 140x150 h

TOOL HOLDER FRAME 4-ROWS AND ACCESSORIES FOR SHELVING SYSTEM F NC 0120 / F NC 0121



TOOL HOLDER FRAME 4-ROWS

ORD. NO.

F NC 5220 00 01

Horizontal frame load capacity: 150 kg

Overall dimensions mm 584x592x69 h



HORIZONTAL PAIR OF CARRIERS

ORD. NO.

F NC 5640 00 01

For frame ORD. NO. F NC 5220 00 ..

Overall dimensions mm 577x112 h

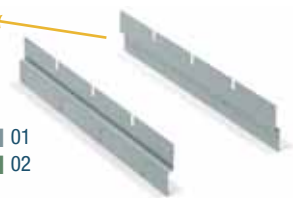

ANGLED PAIR OF CARRIERS

ORD. NO.

F NC 5741 00 01

For frame ORD. NO. F NC 5220 00 ..

Overall dimensions mm 577x114 h



ORD. NO. TOOL HOLDERS

ORD. NO. TOOL HOLDERS	TOOL HOLDER TYPE	MAX. QUANTITY PER TOOL FRAME F NC 5020 00 ..	MAX. QUANTITY PER TOOL FRAME F NC 5220 00 ..
F NC 9510 00 03	ISO 30	7	32
F NC 9530 00 03	ISO 40	7	32
F NC 9540 00 03	ISO 45	5	24
F NC 9550 00 03	ISO 50	5	20
F NC 9560 00 03	VDI 30	7	32
F NC 9570 00 03	VDI 40	5	24
F NC 9580 00 03	VDI 50	5	24
F NC 9590 00 03	VDI 60	5	20
F NC 9720 00 03	MORSE TAPER 2	7	32
F NC 9730 00 03	MORSE TAPER 3	7	32
F NC 9740 00 03	MORSE TAPER 4	7	32
F NC 9750 00 03	MORSE TAPER 5	5	24
F NC 9270 00 03	CAPTO C3	7	32
F NC 9275 00 03	CAPTO C4	5	24
F NC 9280 00 03	CAPTO C5	5	24

ORD. NO. TOOL HOLDERS

ORD. NO. TOOL HOLDERS	TOOL HOLDER TYPE	MAX. QUANTITY PER TOOL FRAME F NC 5020 00 ..	MAX. QUANTITY PER TOOL FRAME F NC 5220 00 ..
F NC 9285 00 03	CAPTO C6	5	24
F NC 9290 00 03	CAPTO C8	4	16
F NC 9210 00 03	HSK A32-B40	7	32
F NC 9220 00 03	HSK A40-B50	7	32
F NC 9230 00 03	HSK A50-B63	5	24
F NC 9240 00 03	HSK A63-B80	5	24
F NC 9250 00 03	HSK A80-B100	4	16
F NC 9260 00 03	HSK A100-B125	4	16
F NC 9640 00 03	2"	5	24
F NC 9650 00 03	2" 1/4	5	20
F NC 9010 00 03	58 mm	9	36
F NC 9020 00 03	65 mm	8	32
F NC 9030 00 03	75 mm	7	28
F NC 9040 00 03	87 mm	6	24
F NC 9050 00 03	105 mm	5	20

SHELVING SYSTEM SERIES NC-SYSTEM



ORD. NO.

F NC 0822 01 51

Including:

- 4 frames 1-row ORD. NO. **F NC 5050 00 01**
- 4 angled pair of carriers ORD. NO. **F NC 5711 00 99**
- 1 telescopic extension drawer
ORD. NO. **F NC 8910 00 04**
- 1 tool frame a 3 file ORD. NO. **F NC 5140 00 01**
- 1 pair of carriers ORD. NO. **F NC 5630 00 01**
- 1 telescopic extension drawer
ORD. NO. **F NC 8915 00 04**
- 1 telescopic retract. shelf ORD. NO. **F NC 8660 00 04**
- Load capacity of shelving system: 1500 kg

Dimensions mm 1042x645x2200 h

Tool holders excluded

ORD. NO.

F NC 0822 04 51

Including:

- 8 frames 1-row ORD. NO. **F NC 5050 00 01**
- 8 pair of angled carriers ORD. NO. **F NC 5711 00 99**
- Load capacity of shelving system: 1500 kg
- Dimensions mm 1042x645x2200 h**

Tool holders excluded

ORD. NO.

F NC 0822 06 51

Including:

- 4 frames 4-rows ORD. NO. **F NC 5250 00 01**
- 4 pair of angled carriers ORD. NO. **F NC 5741 00 01**
- Load capacity of shelving system: 1500 kg
- Dimensions mm 1042x645x2200 h**

Tool holders excluded

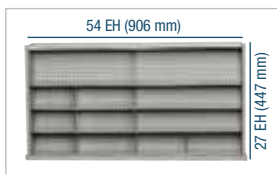

■ Detail of roller shutter door

RAL 7000 F.01 RAL 6011 F.02 RAL 5012 + RAL 7000 F.51

RAL 7035 + RAL 7000 F.56

INFO ■

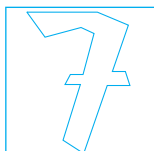

■ Partitioning material see page B46

www.famispa.com

DIMENSIONS = 1042x645x2200 mm

SHELVING SYSTEM SERIES NC-SYSTEM

01 02 51 56



ORD. NO. F NC 0822 13 51

ORD. NO.

F NC 0822 13 51

- Including:
- 3 frames 1-row ORD. NO. **F NC 5050 00 01**
 - 3 pair of angled carriers ORD. NO. **F NC 5711 00 99**
 - 2 frames 3-rows ORD. NO. **F NC 5140 00 01**
 - 2 pair of carriers ORD. NO. **F NC 5630 00 01**
 - 2 telescopic extension drawers
ORD. NO. **F NC 8915 00 04**
 - 1 telescopic retract. shelf ORD. NO. **F NC 8660 00 04**
- Load capacity of shelving system: 1500 kg

Dimensions mm 1042x645x2200 h

Tool holders excluded

ORD. NO.

F NC 0822 12 51

- Including:
- 4 frames 3-rows ORD. NO. **F NC 5140 00 01**
 - 4 pair of carriers ORD. NO. **F NC 5630 00 01**
 - 4 telescopic extension drawers
ORD. NO. **F NC 8915 00 04**

Dimensions mm 1042x645x2200 h

Tool holders excluded

01 02 51 56



ORD. NO. F NC 0822 12 51



ORD. NO.
TOOL HOLDERS

TOOL HOLDER
TYPE

MAX. QUANTITY PER
TOOL FRAME F NC 5050 00 ..

MAX. QUANTITY PER
TOOL FRAME F NC 5140 00 ..

MAX. QUANTITY PER
TOOL FRAME F NC 5250 00 ..

ORD. NO. TOOL HOLDERS	TOOL HOLDER TYPE	MAX. QUANTITY PER TOOL FRAME F NC 5050 00 ..	MAX. QUANTITY PER TOOL FRAME F NC 5140 00 ..	MAX. QUANTITY PER TOOL FRAME F NC 5250 00 ..
F NC 9510 00 03	ISO 30	12	33	48
F NC 9530 00 03	ISO 40	12	33	48
F NC 9540 00 03	ISO 45	10	27	40
F NC 9550 00 03	ISO 50	8	24	32
F NC 9560 00 03	VDI 30	12	33	48
F NC 9570 00 03	VDI 40	10	27	40
F NC 9580 00 03	VDI 50	10	27	40
F NC 9590 00 03	VDI 60	8	24	32
F NC 9720 00 03	MORSE TAPER 2	12	33	48
F NC 9730 00 03	MORSE TAPER 3	12	33	48
F NC 9740 00 03	MORSE TAPER 4	12	33	48
F NC 9750 00 03	MORSE TAPER 5	10	27	40
F NC 9270 00 03	CAPTO C3	12	33	48
F NC 9275 00 03	CAPTO C4	10	27	40
F NC 9280 00 03	CAPTO C5	10	27	40
F NC 9285 00 03	CAPTO C6	10	27	40
F NC 9290 00 03	CAPTO C8	8	21	32
F NC 9210 00 03	HSK A32-B40	12	33	48
F NC 9220 00 03	HSK A40-B50	12	33	48
F NC 9230 00 03	HSK A50-B63	10	27	40
F NC 9240 00 03	HSK A63-B80	10	27	40
F NC 9250 00 03	HSK A80-B100	8	21	32
F NC 9260 00 03	HSK A100-B125	8	21	32
F NC 9640 00 03	2"	10	27	40
F NC 9650 00 03	2" 1/4	8	24	32
F NC 9010 00 03	58 mm	15	42	60
F NC 9020 00 03	65 mm	14	39	56
F NC 9030 00 03	75 mm	12	33	48
F NC 9040 00 03	87 mm	10	27	40
F NC 9050 00 03	105 mm	8	24	32

SHELVING SYSTEM SERIES NC-SYSTEM

EMPTY SHELVING SYSTEM SERIES F NC 0822



ORD. NO.

ANTI-TILT
ROD LENGTH

F NC 0822 00 04

-

Load capacity: 1500 kg

Dim. mm 1042x645x2200 h

ORD. NO.

ANTI-TILT
ROD LENGTH

F NC 0822 11 04

900 mm

F NC 0822 10 04

1225 mm

Load capacity: 1500 kg

Dim. mm 1042x645x2200 h

ORD. NO.

ANTI-TILT
ROD LENGTH

F NC 0822 09 04

1900 mm

Load capacity: 1500 kg

Dim. mm 1042x645x2200 h

FIXING SET



■ Fixing material including (for 1 upright frame) 2 steel floor bolts M8x75 mm for uninterrupted concrete floors equal to higher than class: B25 / RBK250 / MPa 25 N for mm².

ORD. NO. **F NC 8999 00 99**

■ The shelving system must be fixed to the floor or to the wall.

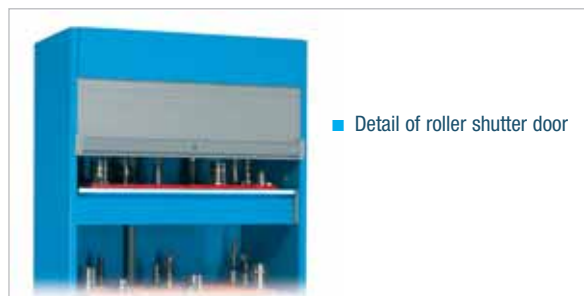

■ Detail of roller shutter door

PLINTHS FOR TRANSPALLET FOR SHELVING SYSTEM F NC 0822



ORD. NO.

F NC 8410 00 07 Plinth height 100 mm

F NC 8430 00 07 Facing piece

RAL 7000 F.01 RAL 6011 F.02 RAL 5012 F.04 RAL 7035 F.08

KEY ■

- The shelving system must be fixed to the floor or to the wall
- All indicated loads are net and refer to evenly distributed weights

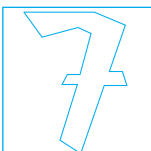

DIMENSIONS = 1042x645x2200 mm

SHELVING SYSTEM SERIES NC-SYSTEM

ADJUSTABLE SHELF FOR SHELVING SYSTEM WITHOUT ANTI-TILT ROD F NC 0822

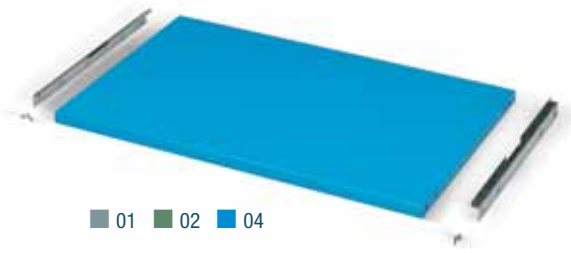

■ 01 ■ 02 ■ 04

ORD. NO.	OVERALL DIMENSIONS mm	LOAD CAPACITY kg
F NC 3810 01 04	980x625x30 h	100

ADJUSTABLE SHELF FOR SHELVING SYSTEM WITH ANTI-TILT ROD F NC 0822



x 4

■ 01 ■ 02 ■ 04

ORD. NO.	USABLE DIMENSIONS mm	SIDE HEIGHT mm	LOAD CAPACITY kg
F NC 3820 01 04	967x465	25	100
Extension: 100%			

54x27 EH FULL TELESCOPIC EXTENSION DRAWERS FOR SHELVING SYSTEM F NC 0822



■ 01 ■ 02 ■ 04 ■ 08

ORD. NO.	USABLE DIMENSIONS mm	FRONT HEIGHT mm	LOAD CAPACITY kg
F NC 8907 00 04	906x447x54 h	75	150
F NC 8910 00 04	906x447x79 h	100	150
F NC 8915 00 04	906x447x129 h	150	150
Extension: 100%			

■ Drawers can be assembled in shelvings with anti-tilt rod.

■ Partitioning material see page B46

54x27 EH FULL TELESCOPIC EXTENSION SHELVES FOR SHELVING SYSTEM F NC 0822



■ 01 ■ 02 ■ 04 ■ 08

ORD. NO.	USABLE DIMENSIONS mm	FRONT HEIGHT mm	LOAD CAPACITY kg
F NC 8660 00 04	916x457 h	85	150
Extension: 100%			

■ Full telescopic extension shelves must be assembled in shelvings with anti-tilt rod.

■ KEY

■ RAL 7000 F... ..01 ■ RAL 6011 F... ..02 ■ RAL 5012 F... ..04 ■ RAL 7035 F... ..08



■ All indicated loads are net and refer to evenly distributed weights

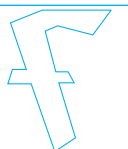

SHELVING SYSTEM SERIES NC-SYSTEM

TOOL HOLDER FRAME 4-ROWS AND ACCESSORIES FOR SHELVING SYSTEM F NC 0822



■ 01
■ 02

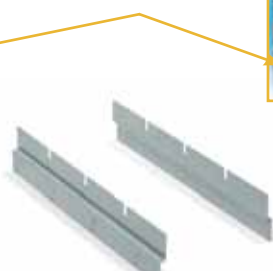

■ 01
■ 02

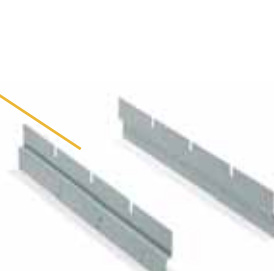

■ 01
■ 02

TOOL HOLDER FRAME 4-ROWS

ORD. NO.

F NC 5250 00 01

Horizontal frame load capacity: 150 kg

Overall dimensions mm 966x592x69 h

HORIZONTAL PAIR OF CARRIERS

ORD. NO.

F NC 5640 00 01

For frame ORD. NO. F NC 5250 00 ..

Overall dimensions mm 577x112 h

ANGLED PAIR OF CARRIERS

ORD. NO.

F NC 5741 00 01

For frame ORD. NO. F NC 5250 00 ..

Overall dimensions mm 577x114 h

TOOL HOLDER FRAME AND ACCESSORIES FOR SHELVING SYSTEM F NC 0822



■ 01
■ 02



■ 99



TOOL HOLDER FRAME

ORD. NO.

F NC 5050 00 01

Horizontal frame load capacity: 80 kg

Dimensions mm 968x140x146 h

PAIR OF GALVANISED HANDLES

ORD. NO.

F NC 5005 00 99

For frame ORD. NO. F NC 5050 00 ..



■ 99



■ 99

PAIR OF GALVANISED HORIZONTAL CARRIERS

ORD. NO.

F NC 5710 00 99

For frame ORD. NO. F NC 5050 00 ..

Overall dimensions mm 140x150 h

PAIR OF GALVANISED ANGLED CARRIERS

ORD. NO.

F NC 5711 00 99

For frame ORD. NO. F NC 5050 00 ..

Overall dimensions mm 140x150 h

RAL 7000 F... ..01 RAL 6011 F... ..02

KEY ■

■ All indicated loads are net and refer to evenly distributed weights



DIMENSIONS = 1042x645x2200 mm

SHELVING SYSTEM SERIES NC-SYSTEM

TOOL HOLDER FRAME 3-ROWS FOR DRAWERS FOR SHELVING SYSTEM F NC 0822

- 01
- 02

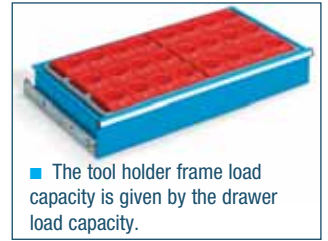
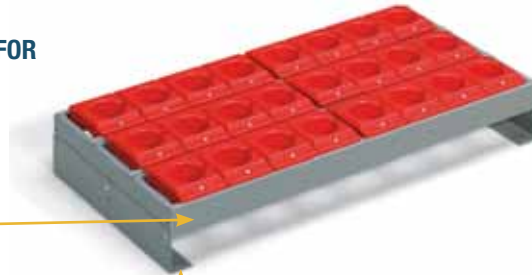

■ The tool holder frame load capacity is given by the drawer load capacity.

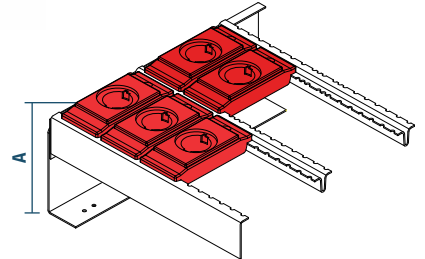

TOOL HOLDER FRAME 3-ROWS

ORD. NO.

F NC 5140 00 01

Overall dimensions mm 890x444x69 h

PAIR OF CARRIERS

ORD. NO.

F NC 5630 00 01

DIMENSIONS mm

446x86 h

FOR LENGTH TAPERS MM REF. A

A = 93 / 118 / 143

F NC 5830 00 01

446x136 h

A = 143 / 168 / 193



ORD. NO.
TOOL HOLDERS

TOOL HOLDER
TYPE

MAX. QUANTITY PER
TOOL FRAME F NC 5050 00 ..

MAX. QUANTITY PER
TOOL FRAME F NC 5140 00 ..

MAX. QUANTITY PER
TOOL FRAME F NC 5250 00 ..

ORD. NO. TOOL HOLDERS	TOOL HOLDER TYPE	MAX. QUANTITY PER TOOL FRAME F NC 5050 00 ..	MAX. QUANTITY PER TOOL FRAME F NC 5140 00 ..	MAX. QUANTITY PER TOOL FRAME F NC 5250 00 ..
F NC 9510 00 03	ISO 30	12	33	48
F NC 9530 00 03	ISO 40	12	33	48
F NC 9540 00 03	ISO 45	10	27	40
F NC 9550 00 03	ISO 50	8	24	32
F NC 9560 00 03	VDI 30	12	33	48
F NC 9570 00 03	VDI 40	10	27	40
F NC 9580 00 03	VDI 50	10	27	40
F NC 9590 00 03	VDI 60	8	24	32
F NC 9720 00 03	MORSE TAPER 2	12	33	48
F NC 9730 00 03	MORSE TAPER 3	12	33	48
F NC 9740 00 03	MORSE TAPER 4	12	33	48
F NC 9750 00 03	MORSE TAPER 5	10	27	40
F NC 9270 00 03	CAPTO C3	12	33	48
F NC 9275 00 03	CAPTO C4	10	27	40
F NC 9280 00 03	CAPTO C5	10	27	40
F NC 9285 00 03	CAPTO C6	10	27	40
F NC 9290 00 03	CAPTO C8	8	21	32
F NC 9210 00 03	HSK A32-B40	12	33	48
F NC 9220 00 03	HSK A40-B50	12	33	48
F NC 9230 00 03	HSK A50-B63	10	27	40
F NC 9240 00 03	HSK A63-B80	10	27	40
F NC 9250 00 03	HSK A80-B100	8	21	32
F NC 9260 00 03	HSK A100-B125	8	21	32
F NC 9640 00 03	2"	10	27	40
F NC 9650 00 03	2" 1/4	8	24	32
F NC 9010 00 03	58 mm	15	42	60
F NC 9020 00 03	65 mm	14	39	56
F NC 9030 00 03	75 mm	12	33	48
F NC 9040 00 03	87 mm	10	27	40
F NC 9050 00 03	105 mm	8	24	32

■ INFO

RAL 7000 F... ..01 RAL 6011 F... ..02



www.famispa.com

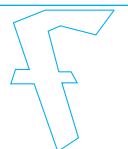

SHELVING SYSTEM SERIES NC-SYSTEM

SET OF PARTITIONS FOR DRAWERS 54x27 EH

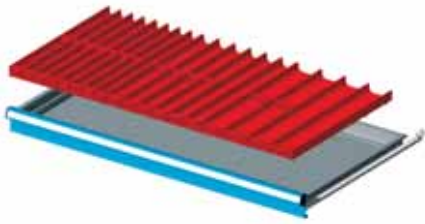

ORD. NO.	FOR FRONT HEIGHTS
----------	-------------------

F FH 4005 12 00	75-150
Set including:	
6 Throughs	4 grooves
15 Through dividers	36 mm
6 Throughs	3 grooves
10 Plain partitions	47 mm
6 Throughs	2 grooves
6 Plain partitions	73 mm

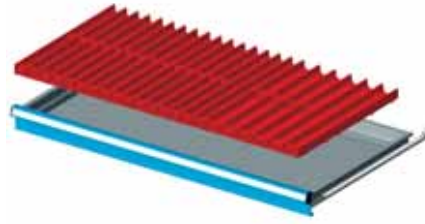

ORD. NO.	FOR FRONT HEIGHTS
----------	-------------------

F FH 4005 15 00	75-150
Set including:	
12 Throughs	4 grooves
30 Through dividers	36 mm
6 Throughs	3 grooves
10 Plain partitions	47 mm



ORD. NO.	FOR FRONT HEIGHTS
----------	-------------------

F FH 4007 01 00	75
F FH 4010 01 00	100
F FH 4015 01 00	150
Set including:	
2 Plain partitions	914 mm

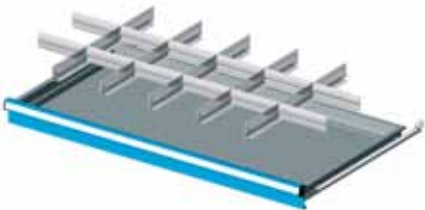

ORD. NO.	FOR FRONT HEIGHTS
----------	-------------------

F FH 4007 03 00	75
F FH 4010 03 00	100
F FH 4015 03 00	150
Set including:	
5 Slotted partitions	455 mm
12 Plain partitions	149 mm

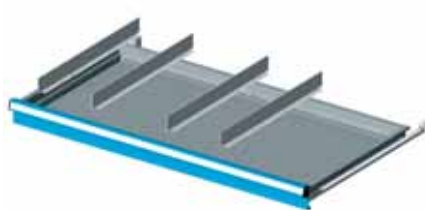

ORD. NO.	FOR FRONT HEIGHTS
----------	-------------------

F FH 4007 04 00	75
F FH 4010 04 00	100
F FH 4015 04 00	150
Set including:	
4 Plain partitions	455 mm

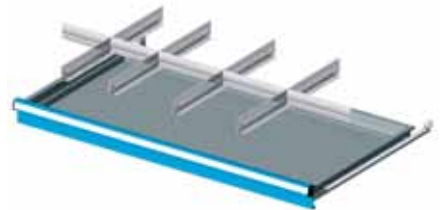

ORD. NO.	FOR FRONT HEIGHTS
----------	-------------------

F FH 4007 05 00	75
F FH 4010 05 00	100
F FH 4015 05 00	150
Set including:	
4 Slotted partitions	455 mm
2 Plain partitions	149 mm
3 Plain partitions	200 mm

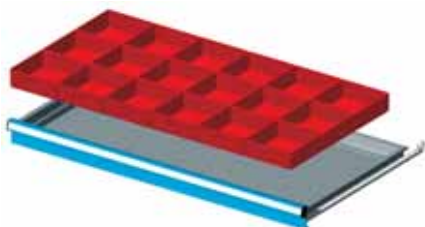

ORD. NO.	FOR FRONT HEIGHTS
----------	-------------------

F FH 4007 11 00	75
F FH 4010 11 00	100
Set including:	
18 Plastic boxes	150x150 mm

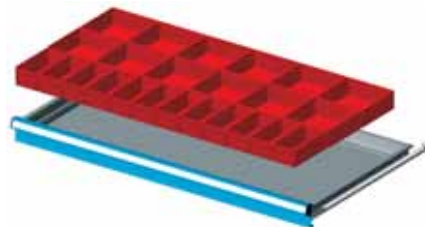

ORD. NO.	FOR FRONT HEIGHTS
----------	-------------------

F FH 4007 13 00	75
F FH 4010 13 00	100
Set including:	
12 Plastic boxes	150x75 mm
12 Plastic boxes	150x150 mm

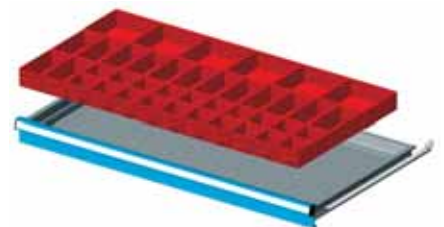

ORD. NO.	FOR FRONT HEIGHTS
----------	-------------------

F FH 4007 16 00	75
Set including:	
20 Plastic boxes	75x75 mm
14 Plastic boxes	150x75 mm
6 Plastic boxes	150x150 mm

KEY ■

■ Partitioning material see page A180



31,5x27 EH

SHELVING SYSTEM SERIES NC-SYSTEM

SET OF PARTITIONS FOR DRAWERS 31,5x27 EH

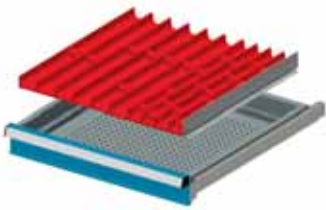

ORD. NO. FOR FRONT HEIGHTS

F FH 8707 01 00 75-150

Set including:

3 Throughs	4 grooves
6 Throughs	3 grooves
16 Through dividers	36 mm
7 Plain partitions	47 mm
1 Plain partition	455 mm

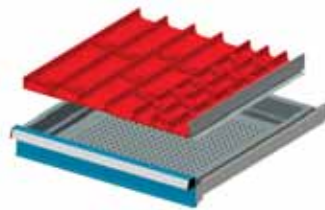

ORD. NO. FOR FRONT HEIGHTS

F FH 8707 02 00 75-150

Set including:

3 Throughs	3 grooves
6 Throughs	2 grooves
15 Through dividers	47 mm
8 Plain partitions	73 mm
1 Plain partition	455 mm

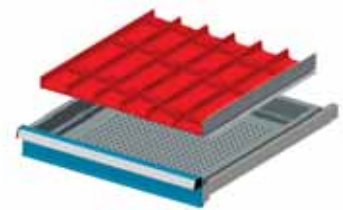

ORD. NO. FOR FRONT HEIGHTS

F FH 8707 03 00 75-150

Set including:

9 Throughs	2 grooves
18 Through dividers	73 mm
1 Plain partition	455 mm

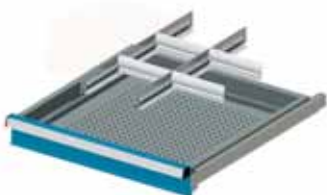

ORD. NO. FOR FRONT HEIGHTS

F FH 8707 04 00 75

F FH 8710 04 00 100

F FH 8715 04 00 150

Set including:

2 Slotted partitions	455 mm
4 Plain partitions	149 mm

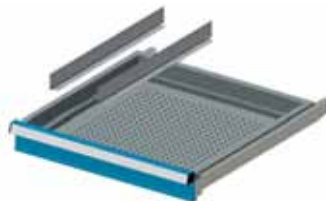

ORD. NO. FOR FRONT HEIGHTS

F FH 8407 13 00 75

F FH 8410 13 00 100

F FH 8415 13 00 150

Set including:

2 Plain partitions	455 mm
--------------------	--------

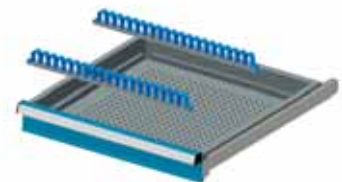

ORD. NO. FOR FRONT HEIGHTS

F FH 8605 19 00 75-150

Set including:

2 Multi-purpose supports	440 mm
--------------------------	--------

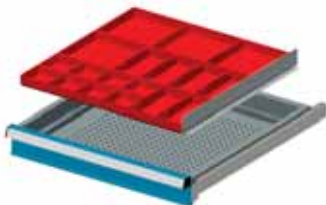

ORD. NO. FOR FRONT HEIGHTS

F FH 8707 05 00 75

Set including:

8 Plastic boxes	75x75 mm
6 Plastic boxes	150x75 mm
4 Plastic boxes	150x150 mm
1 Plain partition	455 mm

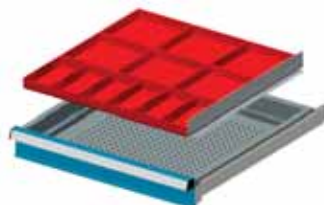

ORD. NO. FOR FRONT HEIGHTS

F FH 8707 06 00 75

F FH 8710 06 00 100

Set including:

6 Plastic boxes	150x75 mm
6 Plastic boxes	150x150 mm
1 Plain partition	455 mm



■ KEY



■ Partitioning material see page A180

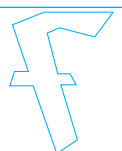



ORD. NO. F AF 1040 15 08
RAL 7035

ORD. NO. F AE 1040 14 50
RAL 7035 + 5012

■ The max. height of the tool holder taper which can be inserted in the drawer frame is **143 mm**. For higher tapers, please see page **B69**.

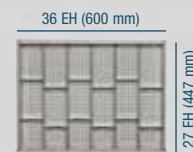
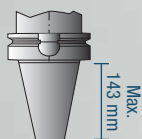

FLOOR FIXING SET



2x

- 2 "HILTI" plugs for concrete floors ≥ to classes B25/RBK250/MPA 25 N/mm²
- Recommended traction of the plug: 2.9 KN
- Plug diameter: Ø 6 mm

ORD. NO. F AG 9204 00 99

CABINET WITH SLIDING DOORS

ORD. NO.	DRAWERS
F AF 1040 15 08	4
Including 4 drawers	
2 retractable shelves	
2 tool holder frames	
Dimensions mm 1431x632x1000 h	
Tools and tool holders excluded	

CABINET WITH LEAF DOORS

ORD. NO.	DRAWERS
F AE 1040 14 50	2
Including 2 drawers	
2 retractable shelves	
Dimensions mm 717x597x1000 h	
Tools excluded	

RAL 7000 F... ..01 RAL 6011 F... ..02 RAL 5012 F... ..04 RAL 7035 F... ..08

SUPPLEMENTARY PARTS ■

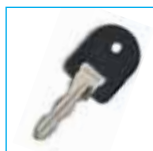
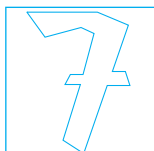

- **Spare key.** Always indicate the number on the cylinder lock of the key to be replaced.
ORD. NO. R CSC 0002 00
- **Master key.** This type of key opens all the 45 and 46 series locks.
ORD. NO. R CSC 0001 00



LENGTH = 717 mm DEPTH = 597/632 mm (36x27 Eh)

CABINETS SERIES NC-STANDARD F27

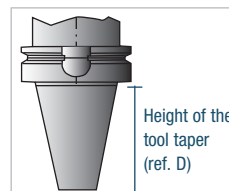
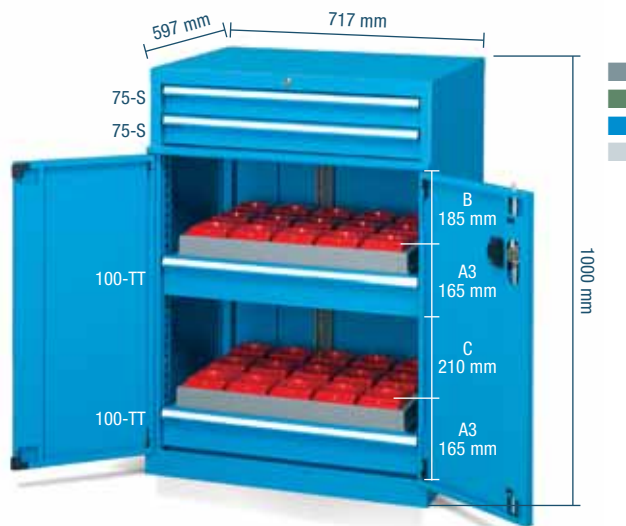

ORD. NO.

F AE 1040 17 04

Including:

- 2 normal extension drawers ORD. NO. **F FG 1007 00 04**
- 2 telescopic extension drawers ORD. NO. **F FG 1110 00 04**
- 2 frames 3-rows ORD. NO. **F NC 5120 00 01**
- 2 pairs of carriers ORD. NO. **F NC 5630 00 01**

Dimensions mm **717x597x1000 h**

Tools excluded

THE TOOL FRAME CAN BE ADJUSTED IN 3 DIFFERENT HEIGHTS

Height frame with drawer	Usable height	Max. height of the tool taper
A1 115 mm	B 235 mm	D 93 mm
A2 140 mm	B 210 mm	D 118 mm
A3 165 mm	B 185 mm	D 143 mm
A1 115 mm	C 260 mm	D 93 mm
A2 140 mm	C 235 mm	D 118 mm
A3 165 mm	C 210 mm	D 143 mm

The adjustment pitch of the drawer is 25 mm in height.

Height drawer with frame

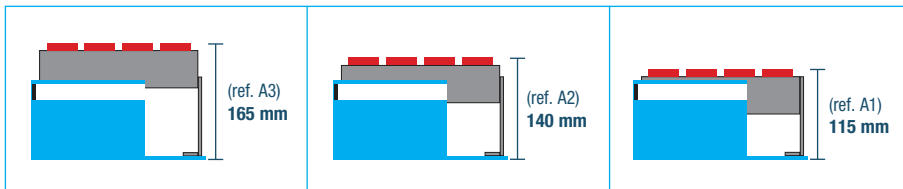

ORD. NO. TOOL HOLDERS

ORD. NO.	TOOL HOLDER TYPE	MAX. QUANTITY PER TOOL FRAME F NC 5120 00 ..
F NC 9510 00 03	ISO 30	24
F NC 9530 00 03	ISO 40	24
F NC 9540 00 03	ISO 45	18
F NC 9550 00 03	ISO 50	15
F NC 9560 00 03	VDI 30	24
F NC 9570 00 03	VDI 40	18
F NC 9580 00 03	VDI 50	18
F NC 9590 00 03	VDI 60	15
F NC 9720 00 03	MORSE TAPER 2	24
F NC 9730 00 03	MORSE TAPER 3	24
F NC 9740 00 03	MORSE TAPER 4	24
F NC 9750 00 03	MORSE TAPER 5	18
F NC 9270 00 03	CAPTO C3	24
F NC 9275 00 03	CAPTO C4	18
F NC 9280 00 03	CAPTO C5	18

ORD. NO. TOOL HOLDERS

ORD. NO.	TOOL HOLDER TYPE	MAX. QUANTITY PER TOOL FRAME F NC 5120 00 ..
F NC 9285 00 03	CAPTO C6	18
F NC 9290 00 03	CAPTO C8	12
F NC 9210 00 03	HSK A32-B40	24
F NC 9220 00 03	HSK A40-B50	24
F NC 9230 00 03	HSK A50-B63	18
F NC 9240 00 03	HSK A63-B80	18
F NC 9250 00 03	HSK A80-B100	12
F NC 9260 00 03	HSK A100-B125	12
F NC 9640 00 03	2"	18
F NC 9650 00 03	2" 1/4	15
F NC 9010 00 03	58 mm	27
F NC 9020 00 03	65 mm	24
F NC 9030 00 03	75 mm	21
F NC 9040 00 03	87 mm	18
F NC 9050 00 03	105 mm	15

KEY



- **S** = normal extension (87%)
- **TT** = telescopic full extension (100%)
- All indicated loads are net and refer to evenly distributed weights



■ Tool frame in the lowest position

■ Partitioning material see page **B57**



RAL 7000 F... ..01 RAL 6011 F... ..02 RAL 5012 F... ..04 RAL 7035 F... ..08

CABINETS SERIES NC-STANDARD F27

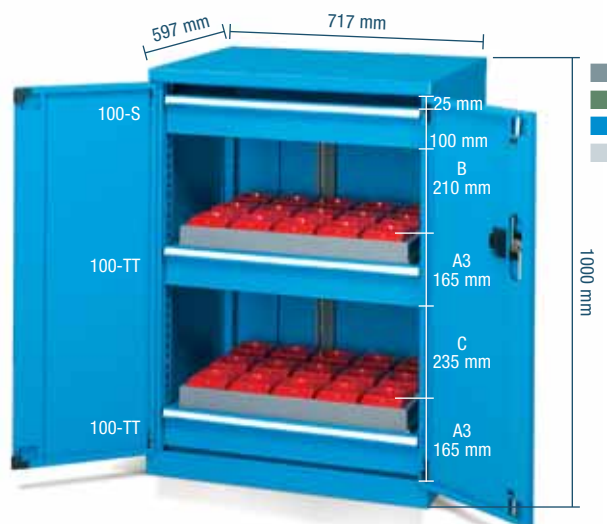
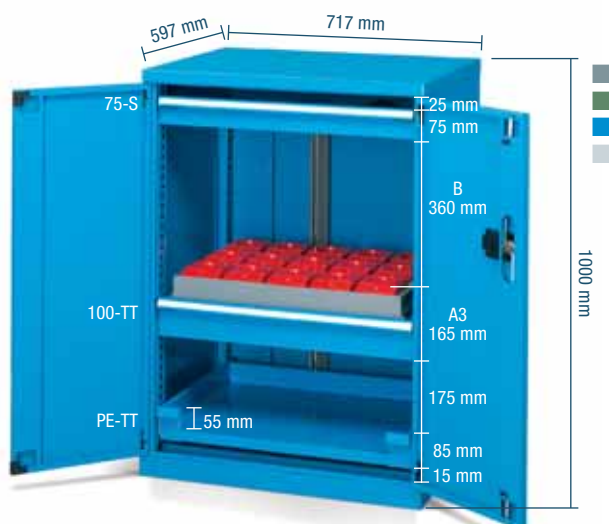

ORD. NO.

F AE 2040 14 04

- Including: 1 normal extension drawer ORD. NO. **F FG 1007 00 04**
 - 1 telescopic extension drawer ORD. NO. **F FG 1110 00 04**
 - 1 telescopic retractable shelf ORD. NO. **F FG 8110 00 04**
 - 1 frame 3-rows ORD. NO. **F NC 5120 00 01**, 1 pair of carriers ORD. NO. **F NC 5630 00 01**
- Dimensions mm 717x597x1000 h Tools excluded

ORD. NO.

F AE 2040 15 04

- Including: 1 normal extension drawer ORD. NO. **F FG 1010 00 04**
 - 2 telescopic extension drawers ORD. NO. **F FG 1110 00 04**
 - 2 frames 3-rows ORD. NO. **F NC 5120 00 01**
 - 2 pairs of carriers ORD. NO. **F NC 5630 00 01**
- Dimensions mm 717x597x1000 h Tools excluded

THE TOOL FRAME CAN BE ADJUSTED IN 3 DIFFERENT HEIGHTS

Height frame with drawer	Usable height	Max. height of the tool taper
A1 115 mm	B 410 mm	D 93 mm
A2 140 mm	B 385 mm	D 118 mm
A3 165 mm	B 360 mm	D 143 mm

The adjustment pitch of the drawer is 25 mm in height.

THE TOOL FRAME CAN BE ADJUSTED IN 3 DIFFERENT HEIGHTS

Height frame with drawer	Usable height	Max. height of the tool taper
A1 115 mm	B 260 mm	D 93 mm
A2 140 mm	B 235 mm	D 118 mm
A3 165 mm	B 210 mm	D 143 mm
A1 115 mm	C 285 mm	D 93 mm
A2 140 mm	C 260 mm	D 118 mm
A3 165 mm	C 235 mm	D 143 mm

The adjustment pitch of the drawer is 25 mm in height.

Height drawer with frame

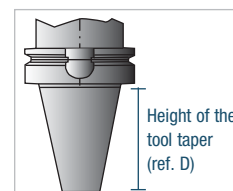
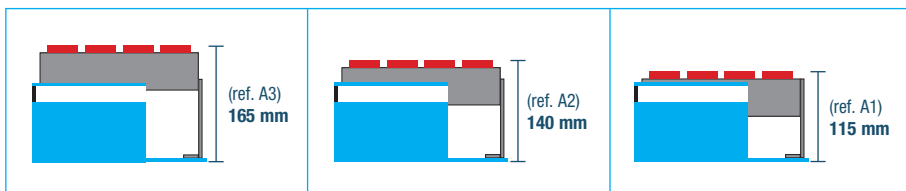

ORD. NO. TOOL HOLDERS

TOOL HOLDER TYPE
MAX. QUANTITY PER TOOL FRAME F NC 5120 00..

F NC 9510 00 03	ISO 30	24
F NC 9530 00 03	ISO 40	24
F NC 9540 00 03	ISO 45	18
F NC 9550 00 03	ISO 50	15
F NC 9560 00 03	VDI 30	24
F NC 9570 00 03	VDI 40	18
F NC 9580 00 03	VDI 50	18
F NC 9590 00 03	VDI 60	15
F NC 9720 00 03	MORSE TAPER 2	24
F NC 9730 00 03	MORSE TAPER 3	24

ORD. NO. TOOL HOLDERS

TOOL HOLDER TYPE
MAX. QUANTITY PER TOOL FRAME F NC 5120 00..

F NC 9740 00 03	MORSE TAPER 4	24
F NC 9750 00 03	MORSE TAPER 5	18
F NC 9270 00 03	CAPTO C3	24
F NC 9275 00 03	CAPTO C4	18
F NC 9280 00 03	CAPTO C5	18
F NC 9285 00 03	CAPTO C6	18
F NC 9290 00 03	CAPTO C8	12
F NC 9210 00 03	HSK A32-B40	24
F NC 9220 00 03	HSK A40-B50	24
F NC 9230 00 03	HSK A50-B63	18

ORD. NO. TOOL HOLDERS

TOOL HOLDER TYPE
MAX. QUANTITY PER TOOL FRAME F NC 5120 00..

F NC 9240 00 03	HSK A63-B80	18
F NC 9250 00 03	HSK A80-B100	12
F NC 9260 00 03	HSK A100-B125	12
F NC 9640 00 03	2"	18
F NC 9650 00 03	2" 1/4	15
F NC 9010 00 03	58 mm	27
F NC 9020 00 03	65 mm	24
F NC 9030 00 03	75 mm	21
F NC 9040 00 03	87 mm	18
F NC 9050 00 03	105 mm	15

RAL 7000 F... ..01 RAL 6011 F... ..02 RAL 5012 F... ..04 RAL 7035 F... ..08

KEY ■

■ Partitioning material see page B57

■ Tool frame in the lowest position



- S = normal extension (87%)
- TT = telescopic full extension (100%)
- All indicated loads are net and refer to evenly distributed weights



LENGTH = 717 mm DEPTH = 597/632 mm (36x27 Eh)

CABINETS SERIES NC-STANDARD F27



RAL 7035 + RAL 5012

CABINET WITH LEAF DOORS

ORD. NO.

F AE 1040 S1 50

including 2 drawers

2 retractable shelves

1 rubber cover with 4 edges

Dimensions mm 717x597x1020 h

Tools excluded

CABINET WITH LEAF DOORS

ORD. NO.

F AE 2040 S1 01

including 4 drawers

2 tool holder frames

1 rubber cover with 3 edges

Dimensions mm 717x597x1020 h

Tools, tool holders,
partitioning material excluded

RAL 7000

■ INFO

RAL 7000 F... ..01 RAL 6011 F... ..02 RAL 5012 F... ..04 RAL 7035 F... ..08



www.famispa.com

■ Tool
frame in the
lowest
position

■ Partitioning
material see
page A180

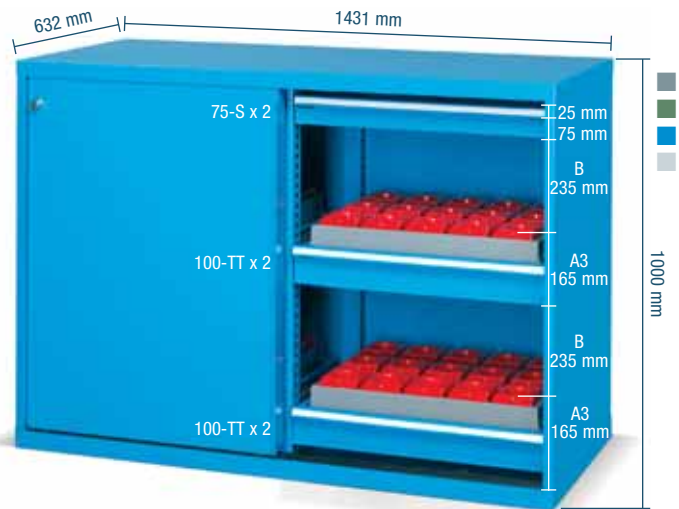
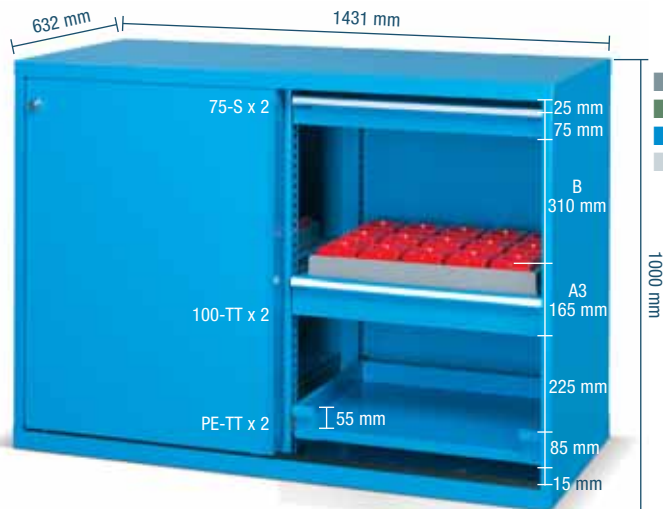

CABINETS SERIES NC-STANDARD F27



ORD. NO.

F AF 1040 15 04

Including: 2 normal extension drawers ORD. NO. **F FG 1007 00 04**
 2 telescopic extension drawers ORD. NO. **F FG 1110 00 04**
 2 telescopic retractable shelves ORD. NO. **F FG 8110 00 04**
 2 frame 3-rows ORD. NO. **F NC 5120 00 01**, 2 pairs of carriers ORD. NO. **F NC 5630 00 01**
Dimensions mm 1431x632x1000 h Tools excluded

THE TOOL FRAME CAN BE ADJUSTED IN 3 DIFFERENT HEIGHTS

Height frame with drawer	Usable height	Max. height of the tool taper
A1 115 mm	B 360 mm	D 93 mm
A2 140 mm	B 335 mm	D 118 mm
A3 165 mm	B 310 mm	D 143 mm

The adjustment pitch of the drawer is 25 mm in height.

ORD. NO.

F AF 1040 16 04

Including: 2 normal extension drawers ORD. NO. **F FG 1007 00 04**
 4 telescopic extension drawers ORD. NO. **F FG 1110 00 04**
 4 frames 3-rows ORD. NO. **F NC 5120 00 01**
 4 pairs of carriers ORD. NO. **F NC 5630 00 01**
Dimensions mm 1431x632x1000 h Tools excluded

THE TOOL FRAME CAN BE ADJUSTED IN 3 DIFFERENT HEIGHTS

Height frame with drawer	Usable height	Max. height of the tool taper
A1 115 mm	B 285 mm	D 93 mm
A2 140 mm	B 260 mm	D 118 mm
A3 165 mm	B 235 mm	D 143 mm

The adjustment pitch of the drawer is 25 mm in height.

Height drawer with frame

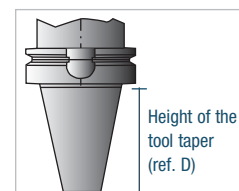
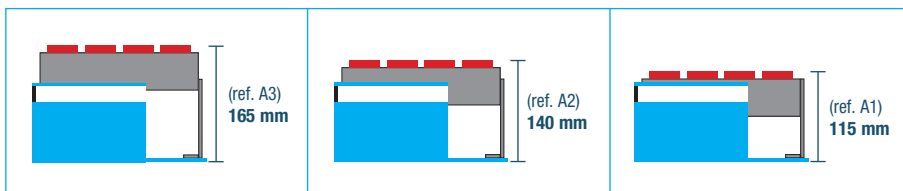

ORD. NO. TOOL HOLDERS	TOOL HOLDER TYPE	MAX. QUANTITY PER TOOL FRAME F NC 5120 00..
F NC 9510 00 03	ISO 30	24
F NC 9530 00 03	ISO 40	24
F NC 9540 00 03	ISO 45	18
F NC 9550 00 03	ISO 50	15
F NC 9560 00 03	VDI 30	24
F NC 9570 00 03	VDI 40	18
F NC 9580 00 03	VDI 50	18
F NC 9590 00 03	VDI 60	15
F NC 9720 00 03	MORSE TAPER 2	24
F NC 9730 00 03	MORSE TAPER 3	24



ORD. NO. TOOL HOLDERS	TOOL HOLDER TYPE	MAX. QUANTITY PER TOOL FRAME F NC 5120 00..
F NC 9740 00 03	MORSE TAPER 4	24
F NC 9750 00 03	MORSE TAPER 5	18
F NC 9270 00 03	CAPTO C3	24
F NC 9275 00 03	CAPTO C4	18
F NC 9280 00 03	CAPTO C5	18
F NC 9285 00 03	CAPTO C6	18
F NC 9290 00 03	CAPTO C8	12
F NC 9210 00 03	HSK A32-B40	24
F NC 9220 00 03	HSK A40-B50	24
F NC 9230 00 03	HSK A50-B63	18



ORD. NO. TOOL HOLDERS	TOOL HOLDER TYPE	MAX. QUANTITY PER TOOL FRAME F NC 5120 00..
F NC 9240 00 03	HSK A63-B80	18
F NC 9250 00 03	HSK A80-B100	12
F NC 9260 00 03	HSK A100-B125	12
F NC 9640 00 03	2"	18
F NC 9650 00 03	2" 1/4	15
F NC 9010 00 03	58 mm	27
F NC 9020 00 03	65 mm	24
F NC 9030 00 03	75 mm	21
F NC 9040 00 03	87 mm	18
F NC 9050 00 03	105 mm	15

RAL 7000 F... ..01 RAL 6011 F... ..02 RAL 5012 F... ..04 RAL 7035 F... ..08

KEY ■

■ Partitioning material see page B57

■ Tool frame in the lowest position

- **S** = normal extension (87%)
- **TT** = telescopic full extension (100%)
- All indicated loads are net and refer to evenly distributed weights

LENGTH = 717 mm DEPTH = 597/632 mm (36x27 Eh)

CABINETS SERIES NC-STANDARD F27



RAL 7035

CABINET WITH SLIDING DOORS**ORD. NO.****F AF 1040 S1 08**including 4 drawers, 2 retractable shelves, 2 tool holder frames,
1 rubber cover with 3 edges**Dimensions mm 1431x632x1020 h**

Tools and tool holders excluded

■ **INFO**

RAL 7000 F... ..01

RAL 6011 F... ..02

RAL 5012 F... ..04

RAL 7035 F... ..08

www.famispa.com

■ Tool
frame in the
lowest
position

■ Partitioning
material see
page **A180**



CABINETS SERIES NC-STANDARD F27

EMPTY CABINET (FB102)

01
02
04
08



ORD. NO. LOAD CAPACITY kg

F AE 1040 00 04 3000

Dimensions mm 717x597x1000 h

Usable height mm 150+725

Cabinet including 2 cylinder locks and 4 keys

ORD. NO.

R CSR 0003 00

Spare lock (for cabinet)

R CSR 0008 00

Spare lock (for door)

R XAE 0001 99

Pair of spare rods (for door)

EMPTY CABINET (FB100)

01
02
04
08



ORD. NO. LOAD CAPACITY kg

F AE 2040 00 04 3000

Dimensions mm 717x597x1000 h

Usable height mm 875

Cabinet including cylinder lock and 2 keys

ORD. NO.

R CSR 0008 00

Spare lock (for door)

R XAE 0002 99

Pair of spare rods (for door)

EMPTY CABINET (FD100)

01
02
04
08



ORD. NO. LOAD CAPACITY kg

F AF 1040 00 04 1500+1500

Dimensions mm 1431x632x1000 h

Usable height mm 875

Cabinet including cylinder lock and 2 keys

ORD. NO.

R CSR 0012 00

Spare lock (for door)

■ The cabinet must be fixed to the wall or floor.
Further information of set of fixing
see page B48.

NORMAL EXTENSION DRAWERS (S)

ORD. NO.	FRONT HEIGHT mm	LOAD CAPACITY kg	USABLE DIM. mm
F FG 1005 00 04	50	60	600x447x36 h
F FG 1007 00 04	75	80	600x447x61 h
F FG 1010 00 04	100	100	600x447x86 h
F FG 1012 00 04	125	100	600x447x111 h

Normal extension (87%)

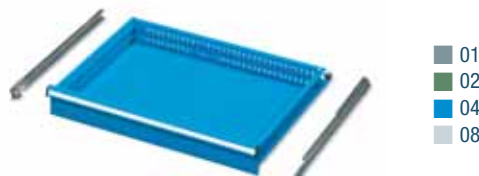

■ Partitioning material see page B57

TELESCOPIC EXTENSION DRAWERS (TT)

ORD. NO.	FRONT HEIGHT mm	LOAD CAPACITY kg	USABLE DIM. mm
F FG 1107 00 04	75	200	600x447x54 h
F FG 1110 00 04	100	200	600x447x79 h
F FG 1112 00 04	125	200	600x447x104 h
F FG 1115 00 04	150	200	600x447x129 h
F FG 1120 00 04	200	200	600x447x179 h
F FG 1125 00 04	250	200	600x447x229 h
F FG 1130 00 04	300	200	600x447x279 h

Telescopic extension (100%)



■ Partitioning material see page B57

NORMAL EXTENSION SHELVES (PE-S)

ORD. NO.	SIDE HEIGHT mm	LOAD CAPACITY kg	USABLE DIM. mm
F FG 8010 00 04	-	100	610x459

Normal extension (87%)



TELESCOPIC EXTENSION SHELVES (PE-TT)

ORD. NO.	SIDE HEIGHT mm	LOAD CAPACITY kg	USABLE DIM. mm
F FG 8110 00 04	-	200	610x459

Telescopic extension (100%)



ADJUSTABLE SHELVES

ORD. NO.	SIDE HEIGHT mm	LOAD CAPACITY kg	USABLE DIM. mm
F SR 1210 01 04	25	150	655x460

Without extension system



LENGTH = 717 mm DEPTH = 597/632 mm (36x27 Eh)

CABINETS SERIES NC-STANDARD F27

CABINET TO CABINET FIXING

■ The article includes:
4 M8 nuts and bolts.
Suitable for fixing same
series cabinets only.

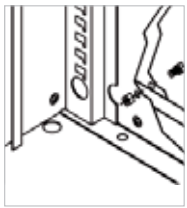
ORD. NO. F AG 9202 00 99**TWO SIDED ADHESIVE TAPE****ORD. NO.****R CMV 0025 00**width 15 mm
length 50 metres

■ 07

PLINTHS

for cabinet F AE 1040 - F AE 2040

ORD. NO.**F RR 0060 00 07**

Plinth height 50 mm



■ 07

PLINTHS

for cabinet F AF 1040

ORD. NO.**F RR 0110 00 07**

Plinth height 50 mm



■ 07

PLINTHS FOR TRANSPALLET

for cabinet F AE 1040 - F AE 2040

ORD. NO.**F RR 0305 00 07** Plinth height 100 mm**F RR 0405 00 07** Facing piece

■ 07

PLINTHS FOR TRANSPALLET

for cabinet F AF 1040

ORD. NO.**F RR 0225 00 07**

Pair of plinths height 100 mm

F RR 0445 00 07

Facing piece



■ 07

PLINTHS FOR FORK LIFT TRUCK

for cabinet F AE 1040 - F AE 2040

ORD. NO.**F RR 0210 00 07**

Pair of plinths height 60 mm

F RR 0400 00 07

Facing piece



■ 07

PLINTHS FOR FORK LIFT TRUCK

for cabinet F AF 1040

ORD. NO.**F RR 0220 00 07**

Pair of plinths height 60 mm

F RR 0440 00 07

Facing piece



■ 07

TOP SHELF

for cabinet F AE 1040

ORD. NO.

DIMENSIONS mm

F AG 9000 01 07

717x573x20 H

oil-resistant rubber cover top with 3 edges



■ 07

TOP SHELF

for cabinet F AE 2040

ORD. NO.

DIMENSIONS mm

F AE 9003 01 07

717x597x20 h

oil-resistant rubber cover top with 3 edges



■ 07

TOP SHELF

for cabinet F AF 1040

ORD. NO.

DIMENSIONS mm

F AF 9000 01 07

1431x630x20 h

oil-resistant rubber cover top with 3 edges

CABINETS SERIES NC-STANDARD F27

TOOL HOLDERS FRAME



ORD. NO.

F NC 5020 00 01

Horizontal frame load capacity: 50 kg
Dimensions mm 584x140x146 h

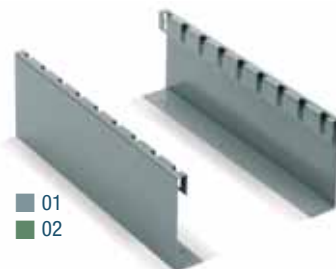

01
02

PAIR OF CARRIERS FOR FRAME

ORD. NO.

F NC 5730 00 01

For frame ORD. NO. F NC 5020 00 ..
Overall dim. mm 442x150 h



■ Example of drawer ORD. NO. F FG 1110 00 04 application with the frames 1-row ORD. NO. F NC 5020 00 01, pair of carriers ORD. NO. F NC 5730 00 01 and 15 tool holders ISO 50.



PAIR OF GALVANISED HANDLES

ORD. NO.

F NC 5005 00 99

For frame ORD. NO. F NC 5020 00 ..

TOOL FOR WOODEN INSERT OF MULTIPLEX



ORD. NO.

F NC 5021 00 01

Horizontal frame load capacity: 50 kg
Overall dimensions mm 584x140x146 h



ORD. NO.

F NC 2510 00 00

Wooden insert of multiplex
Overall dimensions mm 525x138x50 h



Example of tool holder frame ORD. NO. F NC 5021 00 .. with wooden insert

ALUMINIUM INSERT



ORD. NO.

F NC 2410 00 00

Aluminium insert with rubber

OVERALL DIMENSIONS mm

525x135x45 h

WOODEN INSERT



ORD. NO.

F NC 2530 00 01

Wooden insert

OVERALL DIMENSIONS mm

600x450x160 h

01
02



Example of tool holder frame ORD. NO. F NC 5020 00 .. with aluminium support

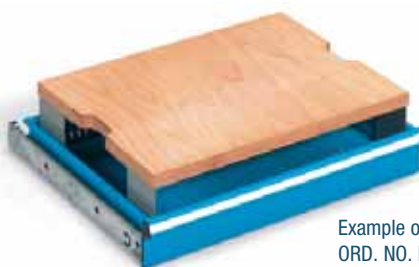

Example of drawer ORD. NO. F FG 1110 00 04 with wooden insert

LENGTH = 717 mm DEPTH = 597/632 mm (36x27 Eh)

CABINETS SERIES NC-STANDARD F27

TOOL HOLDER FRAMES 3-ROWS FOR DRAWERS

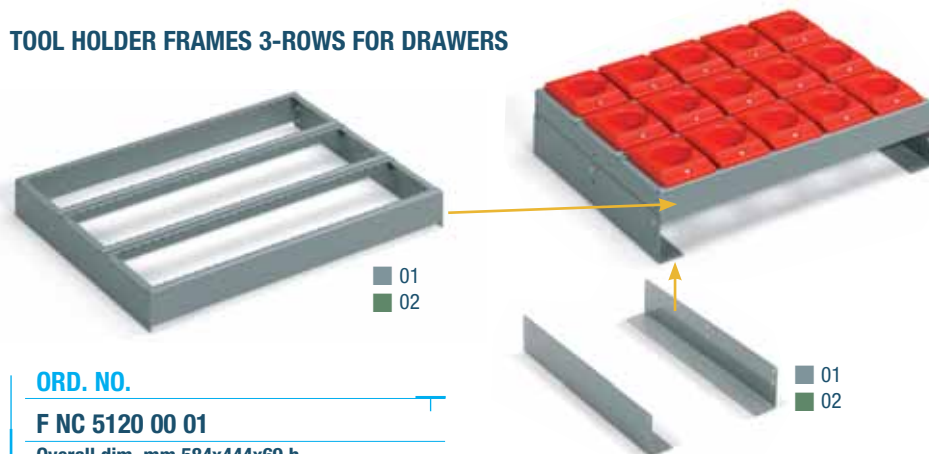

The tool holder frame load capacity is given by the drawer load capacity.

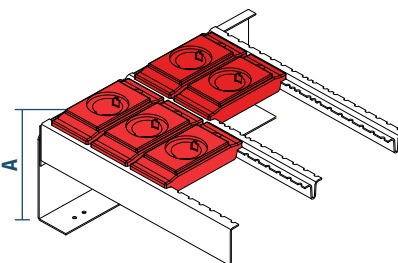

ORD. NO.

F NC 5120 00 01

Overall dim. mm 584x444x69 h

PAIR OF CARRIERS

ORD. NO.

DIMENSIONS mm

FOR HEIGHT TAPER mm REF. A

F NC 5630 00 01

446x86 h

A = 93 / 118 / 143

F NC 5830 00 01

446x136 h

A = 143 / 168 / 193

ORD. NO. TOOL HOLDERS

TOOL HOLDER TYPE

MAX. QUANTITY PER TOOL FRAME F NC 5020 00 ..

MAX. QUANTITY PER TOOL FRAME F NC 5120 00 ..

F NC 9510 00 03	ISO 30	7	24
F NC 9530 00 03	ISO 40	7	24
F NC 9540 00 03	ISO 45	5	18
F NC 9550 00 03	ISO 50	5	15
F NC 9560 00 03	VDI 30	7	24
F NC 9570 00 03	VDI 40	5	18
F NC 9580 00 03	VDI 50	5	18
F NC 9590 00 03	VDI 60	5	15
F NC 9720 00 03	MORSE TAPER 2	7	24
F NC 9730 00 03	MORSE TAPER 3	7	24
F NC 9740 00 03	MORSE TAPER 4	7	24
F NC 9750 00 03	MORSE TAPER 5	5	18
F NC 9270 00 03	CAPTO C3	7	24
F NC 9275 00 03	CAPTO C4	5	18
F NC 9280 00 03	CAPTO C5	5	18

ORD. NO. TOOL HOLDERS

TOOL HOLDER TYPE

MAX. QUANTITY PER TOOL FRAME F NC 5020 00 ..

MAX. QUANTITY PER TOOL FRAME F NC 5120 00 ..

F NC 9285 00 03	CAPTO C6	5	18
F NC 9290 00 03	CAPTO C8	4	12
F NC 9210 00 03	HSK A32-B40	7	24
F NC 9220 00 03	HSK A40-B50	7	24
F NC 9230 00 03	HSK A50-B63	5	18
F NC 9240 00 03	HSK A63-B80	5	18
F NC 9250 00 03	HSK A80-B100	4	12
F NC 9260 00 03	HSK A100-B125	4	12
F NC 9640 00 03	2"	5	18
F NC 9650 00 03	2" 1/4	5	15
F NC 9010 00 03	58 mm	9	27
F NC 9020 00 03	65 mm	8	24
F NC 9030 00 03	75 mm	7	21
F NC 9040 00 03	87 mm	6	18
F NC 9050 00 03	105 mm	5	15

Partitioning material see page A180

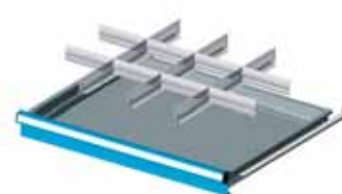
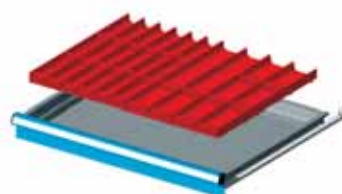
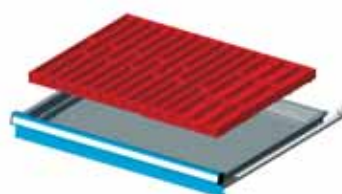
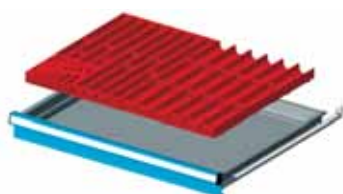

ORD. NO.

FOR FRONT HEIGHTS

F FH 1005 15 00

50-300

Set including:

5 Troughs	4 grooves
20 Plain partitions	36 mm
6 Troughs	3 grooves
20 Plain partitions	47 mm
1 Allen key tray	150x150 mm

ORD. NO.

FOR FRONT HEIGHTS

F FH 1005 10 00

50-300

Set including:

9 Troughs	4 grooves
36 Plain partitions	36 mm
3 Troughs	3 grooves
12 Plain partitions	47 mm

ORD. NO.

FOR FRONT HEIGHTS

F FH 1005 13 00

50-300

Set including:

6 Troughs	3 grooves
18 Plain partitions	47 mm
6 Troughs	2 grooves
12 Plain partitions	73 mm

ORD. NO.

FOR FRONT HEIGHTS

F FH 1005 03 00

50

F FH 1007 03 00

75

F FH 1010 03 00

100-125

F FH 1015 03 00

150-175

F FH 1020 03 00

200-250

Set including:

3 Slotted partitions

455 mm

8 Plain partitions

149 mm

Partitioning material see page A80 - A81

CABINETS SERIES NC-STANDARD F36

LENGTH = 717 mm DEPTH = 750/785 mm (36x36 Eh)



ORD. NO. F AF 3040 17 08
RAL 7035

ORD. NO. F AE 4058 14 01
RAL 7000

■ The max. height of the tool holder taper which can be inserted in the drawer frame is **143 mm**. For higher tapers, please see page **B69**.

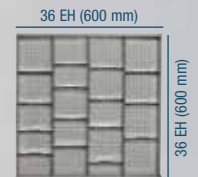
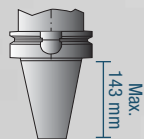

FLOOR FIXING SET



2x

- 2 "HILTI" plugs for concrete floors \geq to classes B25/RBK250/MP_A 25 N/mm²
- Recommended traction of the plug: 2.9 KN
- Plug diameter: \varnothing 6 mm

ORD. NO. F AG 9204 00 99

CABINET WITH SLIDING DOORS

ORD. NO. DRAWERS

F AF 3040 17 08 4

- Including 4 drawers
- 2 retractable shelves
- 2 tool holder frames

Dimensions mm 1431x785x1000 h

Tools and tool holders excluded

CABINET WITH LEAF DOORS

ORD. NO. DRAWERS

F AE 4058 14 01 3

- Including 3 drawers
- 2 retractable shelves
- 1 tool holders frame

Dimensions mm 717x750x1450 h

Tools and tool holders excluded

RAL 7000 F... ..01 RAL 6011 F... ..02 RAL 5012 F... ..04 RAL 7035 F... ..08

SUPPLEMENTARY PARTS

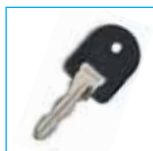
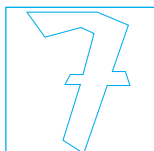

- **Spare key.** Always indicate the number on the cylinder lock of the key to be replaced.
ORD. NO. R CSC 0002 00
- **Master key.** This type of key opens all the 45 and 46 series locks.
ORD. NO. R CSC 0001 00



LENGTH = 717 mm DEPTH = 750/785 mm (36x36 Eh)

CABINETS SERIES NC-STANDARD F36

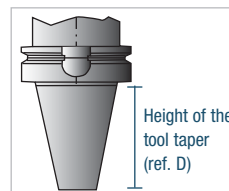
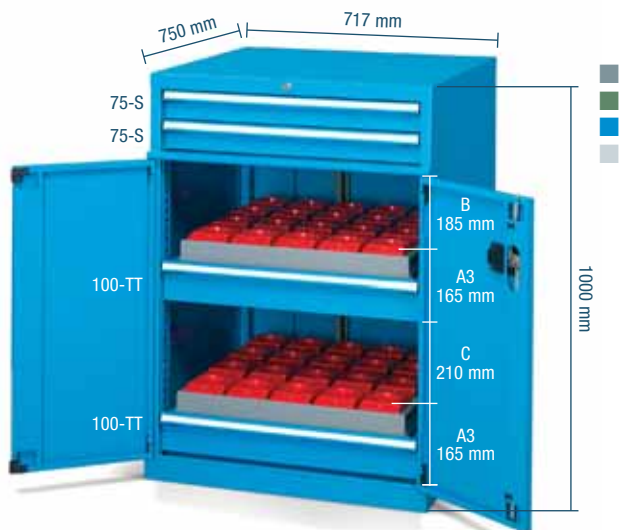

ORD. NO.

F AE 3040 19 04

Including:

- 2 normal extension drawers ORD. NO. **F FG 2007 00 04**
- 2 telescopic extension drawers ORD. NO. **F FG 2110 00 04**
- 2 frames 4-rows ORD. NO. **F NC 5220 00 01**
- 2 pair of carriers ORD. NO. **F NC 5650 00 01**

Dimensions mm 717x750x1000 h

Tools excluded

THE TOOL FRAME CAN BE ADJUSTED IN 3 DIFFERENT HEIGHTS

	Height frame with drawer	Usable height	Max. height of the tool taper
A1	115 mm	B 235 mm	D 93 mm
A2	140 mm	B 210 mm	D 118 mm
A3	165 mm	B 185 mm	D 143 mm
A1	115 mm	C 260 mm	D 93 mm
A2	140 mm	C 235 mm	D 118 mm
A3	165 mm	C 210 mm	D 143 mm

The adjustment pitch of the drawer is 25 mm in height.

Height drawer with frame

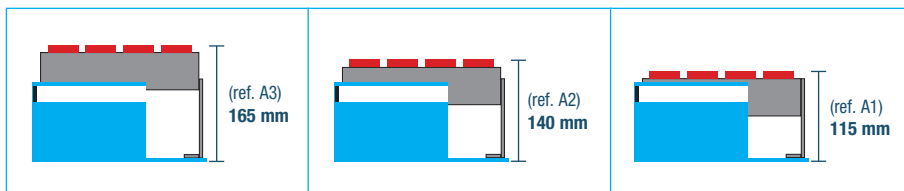

ORD. NO. TOOL HOLDERS

ORD. NO.	TOOL HOLDER TYPE	MAX. QUANTITY PER TOOL FRAME F NC 5220 00 ..
F NC 9510 00 03	ISO 30	32
F NC 9530 00 03	ISO 40	32
F NC 9540 00 03	ISO 45	24
F NC 9550 00 03	ISO 50	20
F NC 9560 00 03	VDI 30	32
F NC 9570 00 03	VDI 40	24
F NC 9580 00 03	VDI 50	24
F NC 9590 00 03	VDI 60	20
F NC 9720 00 03	MORSE TAPER 2	32
F NC 9730 00 03	MORSE TAPER 3	32
F NC 9740 00 03	MORSE TAPER 4	32
F NC 9750 00 03	MORSE TAPER 5	24
F NC 9270 00 03	CAPTO C3	32
F NC 9275 00 03	CAPTO C4	24
F NC 9280 00 03	CAPTO C5	24

ORD. NO. TOOL HOLDERS

ORD. NO.	TOOL HOLDER TYPE	MAX. QUANTITY PER TOOL FRAME F NC 5220 00 ..
F NC 9285 00 03	CAPTO C6	24
F NC 9290 00 03	CAPTO C8	16
F NC 9210 00 03	HSK A32-B40	32
F NC 9220 00 03	HSK A40-B50	32
F NC 9230 00 03	HSK A50-B63	24
F NC 9240 00 03	HSK A63-B80	24
F NC 9250 00 03	HSK A80-B100	16
F NC 9260 00 03	HSK A100-B125	16
F NC 9640 00 03	2"	24
F NC 9650 00 03	2" 1/4	20
F NC 9010 00 03	58 mm	36
F NC 9020 00 03	65 mm	32
F NC 9030 00 03	75 mm	28
F NC 9040 00 03	87 mm	24
F NC 9050 00 03	105 mm	20

KEY

- RAL 7000 F... ..01
- RAL 6011 F... ..02
- RAL 5012 F... ..04
- RAL 7035 F... ..08



- **S** = normal extension (87%)
- **TT** = telescopic full extension (100%)
- All indicated loads are net and refer to evenly distributed weights



■ Tool frame in the lowest position

■ Partitioning material see page **B69**



LENGTH = 717 mm DEPTH = 750/785 mm (36x36 Eh)

CABINETS SERIES NC-STANDARD F36

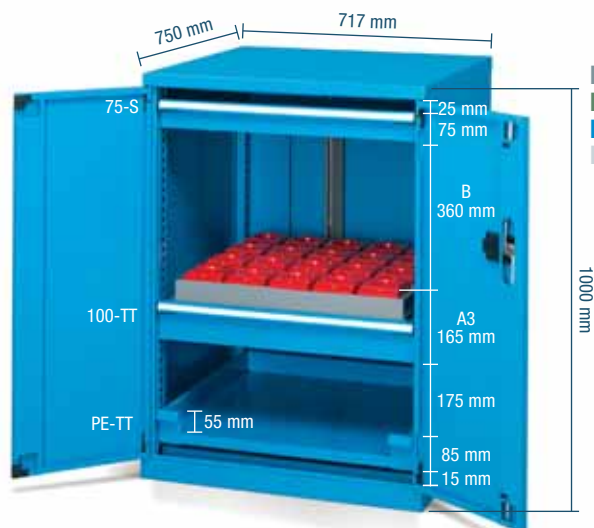

ORD. NO.

F AE 4040 16 04

- Including: 1 normal extension drawer ORD. NO. **F FG 2007 00 04**
 - 1 telescopic extension drawer ORD. NO. **F FG 2110 00 04**
 - 1 telescopic retractable shelf ORD. NO. **F FG 8120 00 04**
 - 1 frame 4-rows ORD. NO. **F NC 5220 00 01**, 1 pair of carriers ORD. NO. **F NC 5650 00 01**
- Dimensions mm 717x750x1000 h** Tools excluded

ORD. NO.

F AE 4040 17 04

- Including: 1 normal extension drawer ORD. NO. **F FG 2010 00 04**
 - 2 telescopic extension drawers ORD. NO. **F FG 2110 00 04**
 - 2 frames 4-rows ORD. NO. **F NC 5220 00 01**
 - 2 pairs of carriers ORD. NO. **F NC 5650 00 01**
- Dimensions mm 717x750x1000 h** Tools excluded

THE TOOL FRAME CAN BE ADJUSTED IN 3 DIFFERENT HEIGHTS

Height frame with drawer	Usable height	Max. height of the tool taper
A1 115 mm	B 410 mm	D 93 mm
A2 140 mm	B 385 mm	D 118 mm
A3 165 mm	B 360 mm	D 143 mm

The adjustment pitch of the drawer is 25 mm in height.

THE TOOL FRAME CAN BE ADJUSTED IN 3 DIFFERENT HEIGHTS

Height frame with drawer	Usable height	Max. height of the tool taper
A1 115 mm	B 260 mm	D 93 mm
A2 140 mm	B 235 mm	D 118 mm
A3 165 mm	B 210 mm	D 143 mm
A1 115 mm	C 285 mm	D 93 mm
A2 140 mm	C 260 mm	D 118 mm
A3 165 mm	C 235 mm	D 143 mm

The adjustment pitch of the drawer is 25 mm in height.

Height drawer with frame

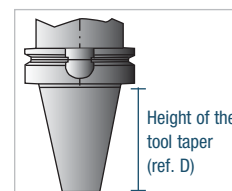
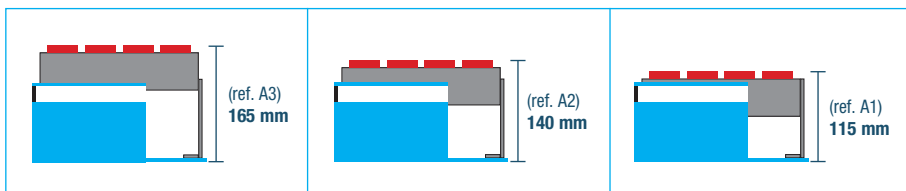

ORD. NO. TOOL HOLDERS

TOOL HOLDER TYPE
MAX. QUANTITY PER TOOL FRAME
F NC 5220 00..

F NC 9510 00 03	ISO 30	32
F NC 9530 00 03	ISO 40	32
F NC 9540 00 03	ISO 45	24
F NC 9550 00 03	ISO 50	20
F NC 9560 00 03	VDI 30	32
F NC 9570 00 03	VDI 40	24
F NC 9580 00 03	VDI 50	24
F NC 9590 00 03	VDI 60	20
F NC 9720 00 03	MORSE TAPER 2	32
F NC 9730 00 03	MORSE TAPER 3	32

ORD. NO. TOOL HOLDERS

TOOL HOLDER TYPE
MAX. QUANTITY PER TOOL FRAME
F NC 5220 00..

F NC 9740 00 03	MORSE TAPER 4	32
F NC 9750 00 03	MORSE TAPER 5	24
F NC 9270 00 03	CAPTO C3	32
F NC 9275 00 03	CAPTO C4	24
F NC 9280 00 03	CAPTO C5	24
F NC 9285 00 03	CAPTO C6	24
F NC 9290 00 03	CAPTO C8	16
F NC 9210 00 03	HSK A32-B40	32
F NC 9220 00 03	HSK A40-B50	32
F NC 9230 00 03	HSK A50-B63	24

ORD. NO. TOOL HOLDERS

TOOL HOLDER TYPE
MAX. QUANTITY PER TOOL FRAME
F NC 5220 00..

F NC 9240 00 03	HSK A63-B80	24
F NC 9250 00 03	HSK A80-B100	16
F NC 9260 00 03	HSK A100-B125	16
F NC 9640 00 03	2"	24
F NC 9650 00 03	2" 1/4	20
F NC 9010 00 03	58 mm	36
F NC 9020 00 03	65 mm	32
F NC 9030 00 03	75 mm	28
F NC 9040 00 03	87 mm	24
F NC 9050 00 03	105 mm	20

RAL 7000 F... ..01 RAL 6011 F... ..02 RAL 5012 F... ..04 RAL 7035 F... ..08

KEY ■

- S = normal extension (87%)
- TT = telescopic full extension (100%)
- All indicated loads are net and refer to evenly distributed weights



■ Partitioning material see page B69

■ Tool frame in the lowest position



LENGTH = 717 mm DEPTH = 750/785 mm (36x36 Eh)

CABINETS SERIES NC-STANDARD F36

**CABINET WITH LEAF DOORS****ORD. NO.****F AE 3040 S1 50**

including 4 drawers

2 tool holder frames

1 MDF top shelf

Dimensions mm 717x750x1030 h

Tools and tool holders excluded

■ RAL 7035 + ■ RAL 5012

CABINET WITH LEAF DOORS**ORD. NO.****F AE 4058 S1 01**

Including 3 drawers

2 retractable shelves

1 tool holders frame

1 rubber cover with 3 edges

Dimensions mm 717x750x1470 h

Tools and tool holders excluded



■ RAL 7000

■ INFO

RAL 7000 F... ..01 RAL 6011 F... ..02 RAL 5012 F... ..04 RAL 7035 F... ..08

www.famispa.com

■ Tool holder frame in the lowest position

■ Partitioning material see page A180



CABINETS SERIES NC-STANDARD F36

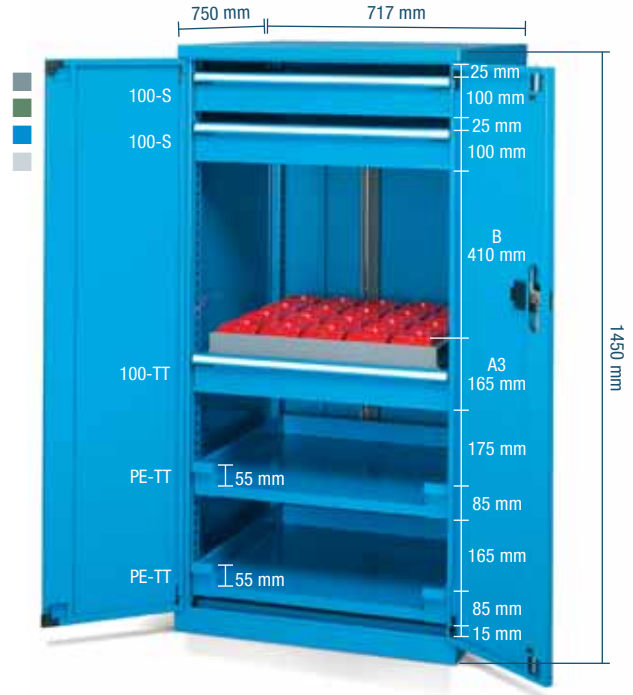
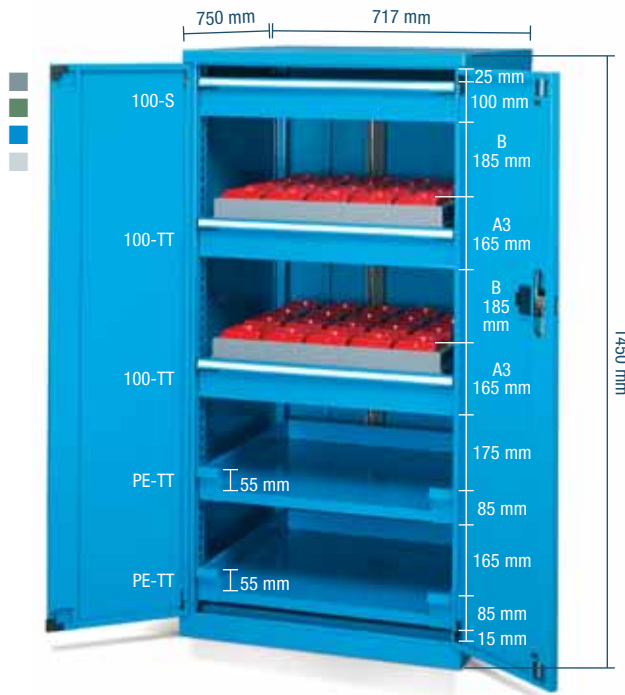

ORD. NO.

F AE 4058 13 04

- Including: 1 normal extension drawer ORD. NO. **F FG 2010 00 04**
- 2 telescopic extension drawers ORD. NO. **F FG 2110 00 04**
- 2 frames 4-rows ORD. NO. **F NC 5220 00 01**, 2 pairs of carriers ORD. NO. **F NC 5650 00 01**
- 2 telescopic retractable shelves ORD. NO. **F FG 8120 00 04**

Dimensions mm 717x750x1450 h Tools excluded

THE TOOL FRAME CAN BE ADJUSTED IN 3 DIFFERENT HEIGHTS

Height frame with drawer	Usable height	Max. height of the tool taper
A1 115 mm	B 235 mm	D 93 mm
A2 140 mm	B 210 mm	D 118 mm
A3 165 mm	B 185 mm	D 143 mm

The adjustment pitch of the drawer is 25 mm in height.

ORD. NO.

F AE 4058 14 04

- Including: 2 normal extension drawers ORD. NO. **F FG 2010 00 04**
- 1 telescopic extension drawer ORD. NO. **F FG 2110 00 04**
- 1 frames 4-rows ORD. NO. **F NC 5220 00 01**, 1 pair of carriers ORD. NO. **F NC 5650 00 01**
- 2 telescopic retractable shelves ORD. NO. **F FG 8120 00 04**

Dimensions mm 717x750x1450 h Tools excluded

THE TOOL FRAME CAN BE ADJUSTED IN 3 DIFFERENT HEIGHTS

Height frame with drawer	Usable height	Max. height of the tool taper
A1 115 mm	B 460 mm	D 93 mm
A2 140 mm	B 435 mm	D 118 mm
A3 165 mm	B 410 mm	D 143 mm

The adjustment pitch of the drawer is 25 mm in height.

Height drawer with frame

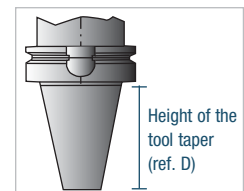
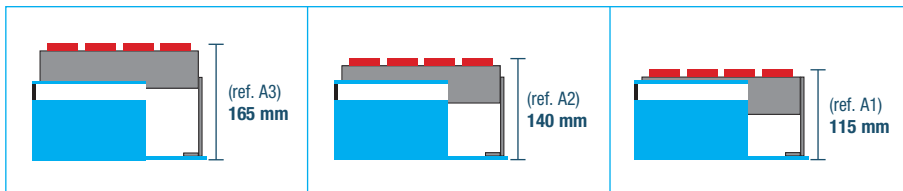

RAL 7000 F... ..01 RAL 6011 F... ..02 RAL 5012 F... ..04 RAL 7035 F... ..08

KEY ■

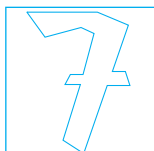

■ Partitioning material see page B69

■ Tool frame in the lowest position



- **S** = normal extension (87%)
- **TT** = telescopic full extension (100%)
- All indicated loads are net and refer to evenly distributed weights



LENGTH = 717 mm DEPTH = 750/785 mm (36x36 Eh)

CABINETS SERIES NC-STANDARD F36

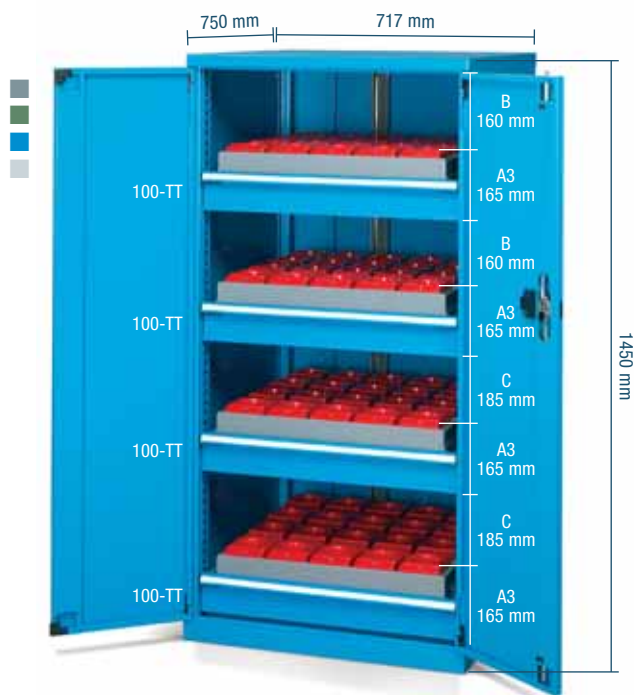

ORD. NO.

F AE 4058 15 04

Including:

4 telescopic extension drawers ORD. NO. **F FG 2110 00 04**

4 frames 4-rows ORD. NO. **F NC 5220 00 01**

4 pairs of carriers ORD. NO. **F NC 5650 00 01**

Dimensions mm **717x750x1450 h**

Tools excluded

ORD. NO.

F AE 4058 16 04

Including:

3 telescopic extension drawers ORD. NO. **F FG 2110 00 04**

3 frames 4-rows ORD. NO. **F NC 5220 00 01**

3 pairs of carriers ORD. NO. **F NC 5650 00 01**

Dimensions mm **717x750x1450 h**

Tools excluded

THE TOOL FRAME CAN BE ADJUSTED IN 3 DIFFERENT HEIGHTS

Height frame with drawer	Usable height	Max. height of the tool taper
A1 115 mm	B 210 mm	D 93 mm
A2 140 mm	B 185 mm	D 118 mm
A3 165 mm	B 160 mm	D 143 mm
A1 115 mm	C 235 mm	D 93 mm
A2 140 mm	C 210 mm	D 118 mm
A3 165 mm	C 185 mm	D 143 mm

The adjustment pitch of the drawer is 25 mm in height.

THE TOOL FRAME CAN BE ADJUSTED IN 3 DIFFERENT HEIGHTS

Height frame with drawer	Usable height	Max. height of the tool taper
A1 115 mm	B 335 mm	D 93 mm
A2 140 mm	B 310 mm	D 118 mm
A3 165 mm	B 285 mm	D 143 mm

The adjustment pitch of the drawer is 25 mm in height.



ORD. NO. TOOL HOLDERS

TOOL HOLDER TYPE
MAX. QUANTITY PER TOOL FRAME
F NC 5220 00..

F NC 9510 00 03	ISO 30	32
F NC 9530 00 03	ISO 40	32
F NC 9540 00 03	ISO 45	24
F NC 9550 00 03	ISO 50	20
F NC 9560 00 03	VDI 30	32
F NC 9570 00 03	VDI 40	24
F NC 9580 00 03	VDI 50	24
F NC 9590 00 03	VDI 60	20
F NC 9720 00 03	MORSE TAPER 2	32
F NC 9730 00 03	MORSE TAPER 3	32



ORD. NO. TOOL HOLDERS

TOOL HOLDER TYPE
MAX. QUANTITY PER TOOL FRAME
F NC 5220 00..

F NC 9740 00 03	MORSE TAPER 4	32
F NC 9750 00 03	MORSE TAPER 5	24
F NC 9270 00 03	CAPTO C3	32
F NC 9275 00 03	CAPTO C4	24
F NC 9280 00 03	CAPTO C5	24
F NC 9285 00 03	CAPTO C6	24
F NC 9290 00 03	CAPTO C8	16
F NC 9210 00 03	HSK A32-B40	32
F NC 9220 00 03	HSK A40-B50	32
F NC 9230 00 03	HSK A50-B63	24



ORD. NO. TOOL HOLDERS

TOOL HOLDER TYPE
MAX. QUANTITY PER TOOL FRAME
F NC 5220 00..

F NC 9240 00 03	HSK A63-B80	24
F NC 9250 00 03	HSK A80-B100	16
F NC 9260 00 03	HSK A100-B125	16
F NC 9640 00 03	2"	24
F NC 9650 00 03	2" 1/4	20
F NC 9010 00 03	58 mm	36
F NC 9020 00 03	65 mm	32
F NC 9030 00 03	75 mm	28
F NC 9040 00 03	87 mm	24
F NC 9050 00 03	105 mm	20

KEY

RAL 7000 F... ..01 RAL 6011 F... ..02 RAL 5012 F... ..04 RAL 7035 F... ..08



- **S** = normal extension (87%)
- **TT** = telescopic full extension (100%)
- All indicated loads are net and refer to evenly distributed weights



■ Tool frame in the lowest position

■ Partitioning material see page **B69**



LENGTH = 717 mm DEPTH = 750/785 mm (36x36 Eh)

CABINETS SERIES NC-STANDARD F36

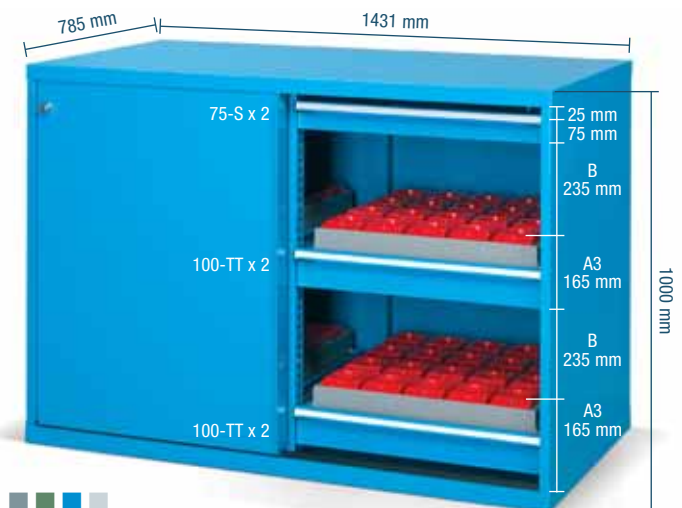
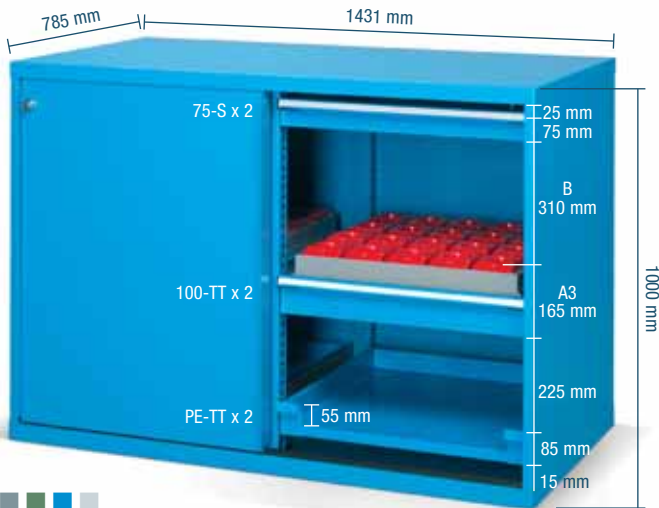

ORD. NO.

F AF 3040 17 04

Including: 2 normal extension drawers ORD. NO. **F FG 2007 00 04**
 2 telescopic extension drawers ORD. NO. **F FG 2110 00 04**
 2 telescopic retractable shelves ORD. NO. **F FG 8120 00 04**
 2 frames 4-rows ORD. NO. **F NC 5220 00 01**, 2 pairs of carriers ORD. NO. **F NC 5650 00 01**
Dimensions mm 1431x785x1000 h Tools excluded

ORD. NO.

F AF 3040 18 04

Including: 2 normal extension drawers ORD. NO. **F FG 2007 00 04**
 4 telescopic extension drawers ORD. NO. **F FG 2110 00 04**
 4 frames 4-rows ORD. NO. **F NC 5220 00 01**
 4 pairs of carriers ORD. NO. **F NC 5650 00 01**
Dimensions mm 1431x785x1000 h Tools excluded

THE TOOL FRAME CAN BE ADJUSTED IN 3 DIFFERENT HEIGHTS

Height frame with drawer	Usable height	Max. height of the tool taper
A1 115 mm	B 360 mm	D 93 mm
A2 140 mm	B 335 mm	D 118 mm
A3 165 mm	B 310 mm	D 143 mm

The adjustment pitch of the drawer is 25 mm in height.

THE TOOL FRAME CAN BE ADJUSTED IN 3 DIFFERENT HEIGHTS

Height frame with drawer	Usable height	Max. height of the tool taper
A1 115 mm	B 285 mm	D 93 mm
A2 140 mm	B 260 mm	D 118 mm
A3 165 mm	B 235 mm	D 143 mm

The adjustment pitch of the drawer is 25 mm in height.

Height drawer with frame

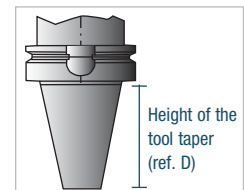
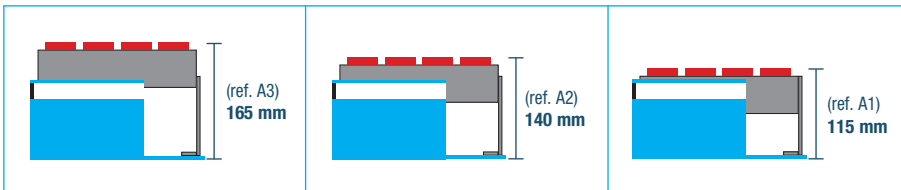

ORD. NO. TOOL HOLDERS

TOOL HOLDER TYPE
 MAX. QUANTITY PER TOOL FRAME F NC 5220 00..

F NC 9510 00 03	ISO 30	32
F NC 9530 00 03	ISO 40	32
F NC 9540 00 03	ISO 45	24
F NC 9550 00 03	ISO 50	20
F NC 9560 00 03	VDI 30	32
F NC 9570 00 03	VDI 40	24
F NC 9580 00 03	VDI 50	24
F NC 9590 00 03	VDI 60	20
F NC 9720 00 03	MORSE TAPER 2	32
F NC 9730 00 03	MORSE TAPER 3	32

ORD. NO. TOOL HOLDERS

TOOL HOLDER TYPE
 MAX. QUANTITY PER TOOL FRAME F NC 5220 00..

F NC 9740 00 03	MORSE TAPER 4	32
F NC 9750 00 03	MORSE TAPER 5	24
F NC 9270 00 03	CAPTO C3	32
F NC 9275 00 03	CAPTO C4	24
F NC 9280 00 03	CAPTO C5	24
F NC 9285 00 03	CAPTO C6	24
F NC 9290 00 03	CAPTO C8	16
F NC 9210 00 03	HSK A32-B40	32
F NC 9220 00 03	HSK A40-B50	32
F NC 9230 00 03	HSK A50-B63	24

ORD. NO. TOOL HOLDERS

TOOL HOLDER TYPE
 MAX. QUANTITY PER TOOL FRAME F NC 5220 00..

F NC 9240 00 03	HSK A63-B80	24
F NC 9250 00 03	HSK A80-B100	16
F NC 9260 00 03	HSK A100-B125	16
F NC 9640 00 03	2"	24
F NC 9650 00 03	2" 1/4	20
F NC 9010 00 03	58 mm	36
F NC 9020 00 03	65 mm	32
F NC 9030 00 03	75 mm	28
F NC 9040 00 03	87 mm	24
F NC 9050 00 03	105 mm	20

RAL 7000 F... ..01 RAL 6011 F... ..02 RAL 5012 F... ..04 RAL 7035 F... ..08

KEY ■

- S = normal extension (87%)
- TT = telescopic full extension (100%)
- All indicated loads are net and refer to evenly distributed weights



■ Partitioning material see page B69

■ Tool frame in the lowest position



LENGTH = 717 mm DEPTH = 750/785 mm (36x36 Eh)

CABINETS SERIES NC-STANDARD F36

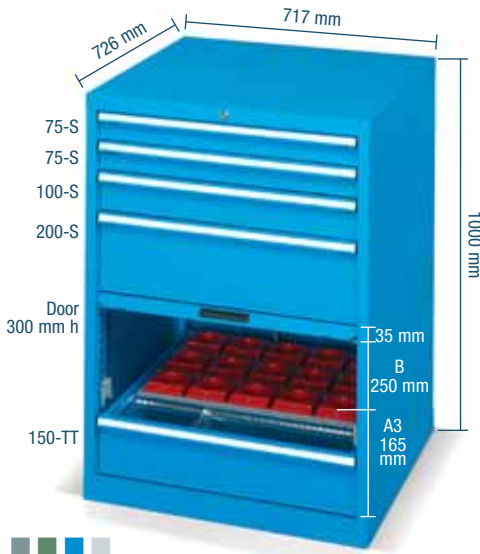

ORD. NO. F AG 2040 28 04

Including: 1 flap door ORD. NO. **F AG 9530 00 04**,
 1 telescopic extension drawer ORD. NO. **F FG 2115 00 04**,
 2 normal extension drawers ORD. NO. **F FG 2007 00 04**,
 1 normal extension drawer ORD. NO. **F FG 2010 00 04**,
 1 normal extension drawer ORD. NO. **F FG 2020 00 04**, 1 frame 3-rows ORD. NO. **F NC 5120 00 01**,
 1 pair of carriers ORD. NO. **F NC 5630 00 01**, 1 slotted partition ORD. NO. **F HA 1440 00 99**
 1 plain partition ORD. NO. **F HA 3440 00 00**

Dimensions mm 717x726x1000 h

Tools excluded

THE TOOL FRAME CAN BE ADJUSTED IN 3 DIFFERENT HEIGHTS

Height frame	Usable height	Max. height of the tool taper
A1 115 mm	B 300 mm	D 93 mm
A2 140 mm	B 275 mm	D 118 mm
A3 165 mm	B 250 mm	D 143 mm

The adjustment pitch of the drawer is 25 mm in height.

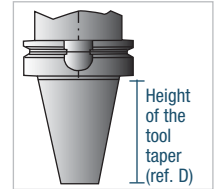

■ Cabinet ORD. NO. **F AG 2040 28 04** with closed flap door

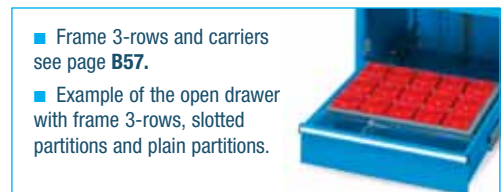

■ Frame 3-rows and carriers see page **B57**.
 ■ Example of the open drawer with frame 3-rows, slotted partitions and plain partitions.

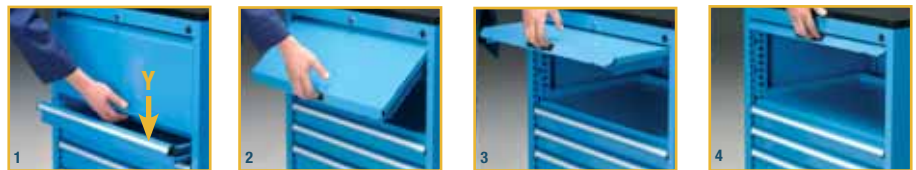
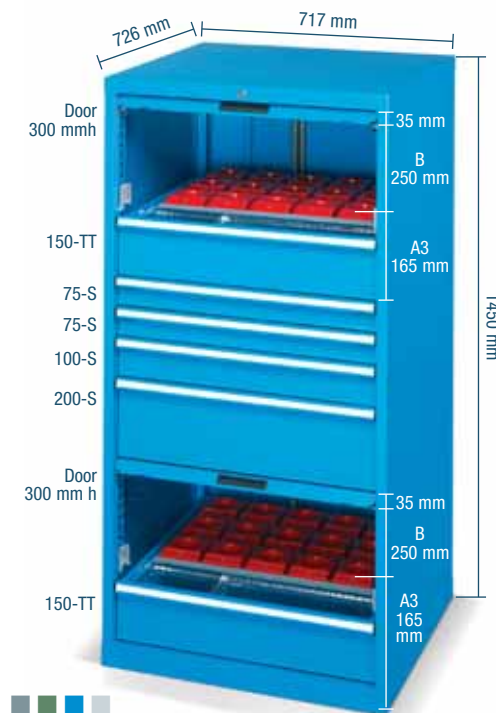

■ The door can be closed by the edge of the lower drawer handle (ref. Y)

ORD. NO. F AG 2058 12 04

Including: 2 flap doors ORD. NO. **F AG 9530 00 04**,
 2 telescopic extension drawers ORD. NO. **F FG 2115 00 04**,
 2 normal extension drawers ORD. NO. **F FG 2007 00 04**,
 1 normal extension drawer ORD. NO. **F FG 2010 00 04**,
 1 normal extension drawer ORD. NO. **F FG 2020 00 04**, 2 frames 3-rows ORD. NO. **F NC 5120 00 01**,
 2 pairs of carriers ORD. NO. **F NC 5630 00 01**, 2 slotted partitions ORD. NO. **F HA 1440 00 99**,
 2 plain partitions ORD. NO. **F HA 3440 00 00**

Dimensions mm 717x726x1450 h

Tools excluded

THE TOOL FRAME CAN BE ADJUSTED IN 3 DIFFERENT HEIGHTS

Height frame	Usable height	Max. height of the tool taper
A1 115 mm	B 300 mm	D 93 mm
A2 140 mm	B 275 mm	D 118 mm
A3 165 mm	B 250 mm	D 143 mm

The adjustment pitch of the drawer is 25 mm in height.

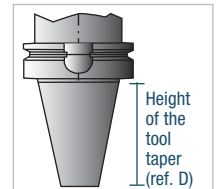

ORD. NO. TOOL HOLDERS TOOL HOLDER TYPE MAX. QUANTITY PER TOOL FRAME F NC 5120 00..

F NC 9510 00 03	ISO 30	24
F NC 9530 00 03	ISO 40	24
F NC 9540 00 03	ISO 45	18
F NC 9550 00 03	ISO 50	15
F NC 9560 00 03	VDI 30	24
F NC 9570 00 03	VDI 40	18
F NC 9580 00 03	VDI 50	18
F NC 9590 00 03	VDI 60	15
F NC 9720 00 03	MORSE TAPER 2	24
F NC 9730 00 03	MORSE TAPER 3	24



ORD. NO. TOOL HOLDERS TOOL HOLDER TYPE MAX. QUANTITY PER TOOL FRAME F NC 5120 00..

F NC 9740 00 03	MORSE TAPER 4	24
F NC 9750 00 03	MORSE TAPER 5	18
F NC 9270 00 03	CAPTO C3	24
F NC 9275 00 03	CAPTO C4	18
F NC 9280 00 03	CAPTO C5	18
F NC 9285 00 03	CAPTO C6	18
F NC 9290 00 03	CAPTO C8	12
F NC 9210 00 03	HSK A32-B40	24
F NC 9220 00 03	HSK A40-B50	24
F NC 9230 00 03	HSK A50-B63	18



ORD. NO. TOOL HOLDERS TOOL HOLDER TYPE MAX. QUANTITY PER TOOL FRAME F NC 5120 00..

F NC 9240 00 03	HSK A63-B80	18
F NC 9250 00 03	HSK A80-B100	12
F NC 9260 00 03	HSK A100-B125	12
F NC 9640 00 03	2"	18
F NC 9650 00 03	2" 1/4	15
F NC 9010 00 03	58 mm	27
F NC 9020 00 03	65 mm	24
F NC 9030 00 03	75 mm	21
F NC 9040 00 03	87 mm	18
F NC 9050 00 03	105 mm	15

CABINETS SERIES NC-STANDARD F36

EMPTY CABINET (FA100)



■ 01
■ 02
■ 04
■ 08

ORD. NO. LOAD CAPACITY kg

F AE 3040 00 04 3000

Dimensions mm 717x750x1000 h

Usable height mm 150+725

Cabinet including 2 cylinder locks and 4 keys

ORD. NO.

R CSR 0003 00

Spare lock (for cabinet)

R CSR 0008 00

Spare lock (for door)

R XAE 0001 99

Pair of spare rods (for door)

EMPTY CABINET (F100 - F145)



■ 01
■ 02
■ 04
■ 08

ORD. NO. LOAD CAPACITY kg

F AE 4040 00 04 3000

Dimensions mm 717x750x1000 h

Usable height mm 875

F AE 4058 00 04 3000

Dimensions mm 717x750x1450 h

Usable height mm 1325

Cabinet including cylinder lock and 2 keys

ORD. NO.

R CSR 0008 00

Spare lock (for door)

R XAE 0002 99

Pair of spare rods (for door) cabinet F AE 4040

R XAE 0003 99

Pair of spare rods (for door) cabinet F AE 4058

EMPTY CABINET (FC100)



■ 01
■ 02
■ 04
■ 08

ORD. NO. LOAD CAPACITY kg

F AF 3040 00 04 1500+1500

Dimensions mm 1431x785x1000 h

Usable height mm 875

Cabinet including cylinder lock and 2 keys

ORD. NO.

R CSR 0012 00

Spare lock (for door)

■ The cabinet must be fixed to the wall or floor.
Further information of set of fixing
see page B48.

NORMAL EXTENSION DRAWERS (S)

ORD. NO.	FRONT HEIGHT mm	LOAD CAPACITY kg	USABLE DIM. mm
F FG 2005 00 04	50	60	600x600x36 h
F FG 2007 00 04	75	80	600x600x61 h
F FG 2010 00 04	100	100	600x600x86 h
F FG 2012 00 04	125	100	600x600x111 h
F FG 2015 00 04	150	100	600x600x136 h
F FG 2017 00 04	175	100	600x600x161 h
F FG 2020 00 04	200	100	600x600x186 h
F FG 2030 00 04	300	100	600x600x286 h

Normal extension (87%)



■ 01
■ 02
■ 04
■ 08

■ Partitioning material see page B69

TELESCOPIC EXTENSION DRAWERS (TT)

ORD. NO.	FRONT HEIGHT mm	LOAD CAPACITY kg	USABLE DIM. mm
F FG 2107 00 04	75	200	600x600x54 h
F FG 2110 00 04	100	200	600x600x79 h
F FG 2112 00 04	125	200	600x600x104 h
F FG 2115 00 04	150	200	600x600x129 h
F FG 2117 00 04	175	200	600x600x154 h
F FG 2120 00 04	200	200	600x600x179 h
F FG 2125 00 04	250	200	600x600x229 h
F FG 2130 00 04	300	200	600x600x279 h
F FG 2140 00 04	400	200	600x600x379 h

Telescopic extension (100%)



■ 01
■ 02
■ 04
■ 08

■ Partitioning material see page B69

NORMAL EXTENSION SHELVES (PE-S)

ORD. NO.	SIDE HEIGHT mm	LOAD CAPACITY kg	USABLE DIM. mm
F FG 8020 00 04	-	100	610x610

Normal extension (87%)



■ 01
■ 02
■ 04
■ 08

LENGTH = 717 mm DEPTH = 750/785 mm (36x36 Eh)

CABINETS SERIES NC-STANDARD F36

TELESCOPIC EXTENSION SHELVES (PE-TT)

ORD. NO.	SIDE HEIGHT mm	LOAD CAPACITY kg	USABLE DIM. mm
F FG 8120 00 04	-	200	610x610

Telescopic extension (100%)



ADJUSTABLE SHELVES

ORD. NO.	SIDE HEIGHT mm	LOAD CAPACITY kg	USABLE DIMENSIONS mm
F SR 1260 01 04	25	150	618x618

Without extension



CABINET TO CABINET FIXING

■ The article includes:
4 M8 nuts and bolts.
Suitable for fixing same series cabinets only.

ORD. NO. F AG 9202 00 99

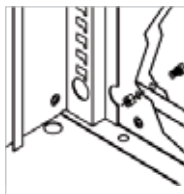

TWO SIDED ADHESIVE TAPE

ORD. NO.

R CMV 0025 00

width 15 mm
length 50 metres



PLINTHS
for cabinet F AE 3040 - F AE 4040 - F AE 4058

ORD. NO.

F RR 0080 00 07

Plinth height 50 mm



PLINTHS
for cabinet F AF 3040

ORD. NO.

F RR 0145 00 07

Plinth height 50 mm



PLINTHS FOR TRANSPALLET
for cabinet F AE 3040 - F AE 4040 - F AE 4058

ORD. NO.

F RR 0315 00 07 Plinth height 100 mm

F RR 0405 00 07 Facing piece



PLINTHS FOR TRANSPALLET
for cabinet F AF 3040

ORD. NO.

F RR 0255 00 07 Pair of plinths height 100 mm

F RR 0445 00 07 Facing piece



PLINTHS FOR FORK LIFT TRUCK
for cabinet F AE 3040 - F AE 4040 - F AE 4058

ORD. NO.

F RR 0240 00 07 Pair of plinths height 60 mm

F RR 0400 00 07 Facing piece



PLINTHS FOR FORK LIFT TRUCK
for cabinet F AF 3040

ORD. NO.

F RR 0250 00 07 Pair of plinths height 60 mm

F RR 0440 00 07 Facing piece



TOP SHELF
for cabinet F AE 3040

ORD. NO. DIMENSIONS mm

F AG 9003 01 07 717x726x20 h

oil-resistant rubber cover top with 3 edges



TOP SHELF
for cabinet F AE 4040 - F AE 4058

ORD. NO. DIMENSIONS mm

F AE 9009 01 07 717x750x20 h

oil-resistant rubber cover top with 3 edges



TOP SHELF
for cabinet F AF 3040

ORD. NO. DIMENSIONS mm

F AF 9006 01 07 1431x785x20 h

oil-resistant rubber cover top with 3 edges

CABINETS SERIES NC-STANDARD F36

TOOL HOLDERS FRAME



ORD. NO.

F NC 5020 00 01

Horizontal frame load capacity: 50 kg

Dimensions mm 584x140x146 h

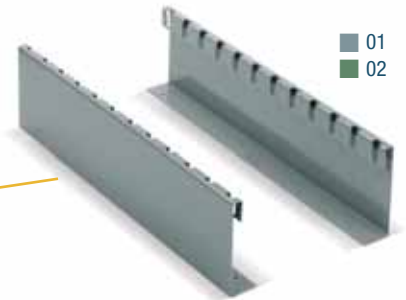
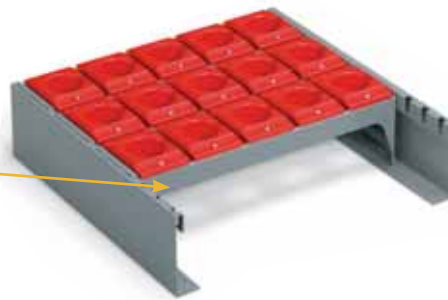

PAIR OF CARRIERS FOR FRAME

ORD. NO.

F NC 5750 00 01

For frame ORD. NO. F NC 5020 00 ..

Overall dim. mm 592x150 h

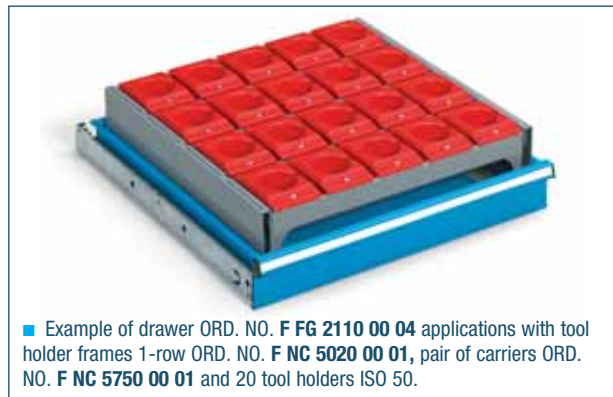

■ Example of drawer ORD. NO. F FG 2110 00 04 applications with tool holder frames 1-row ORD. NO. F NC 5020 00 01, pair of carriers ORD. NO. F NC 5750 00 01 and 20 tool holders ISO 50.



PAIR OF GALVANISED HANDLES

ORD. NO.

F NC 5005 00 99

For frame ORD. NO. F NC 5020 00 ..

TOOL FOR WOODEN INSERT OF MULTIPLEX



ORD. NO.

F NC 5021 00 01

Horizontal frame load capacity: 50 kg

Overall dimensions mm 584x140x146 h



ORD. NO.

F NC 2510 00 00

Wooden insert of multiplex

Overall dimensions mm 525x138x50 h



Example of tool holder frame ORD. NO. F NC 5021 00 .. with wooden insert

ALUMINIUM INSERT



ORD. NO.

F NC 2410 00 00

Aluminium insert with rubber

OVERALL DIMENSIONS mm

525x135x45 h



Example of tool holder frame ORD. NO. F NC 5020 00 .. with aluminium support

WOODEN INSERTS



ORD. NO.

F NC 2550 00 01

Wooden insert

OVERALL DIMENSIONS mm

600x600x160 h



Example of drawer ORD. NO. F FG 2110 00 04 with wooden insert

LENGTH = 717 mm DEPTH = 750/785 mm (36x36 Eh)

CABINETS SERIES NC-STANDARD F36

TOOL HOLDER FRAMES 4-ROWS FOR DRAWERS

- 01
- 02

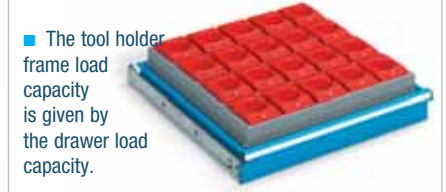
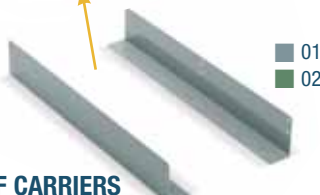
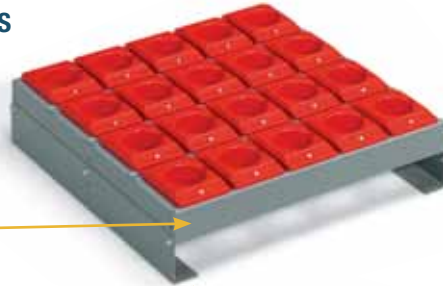

■ The tool holder frame load capacity is given by the drawer load capacity.

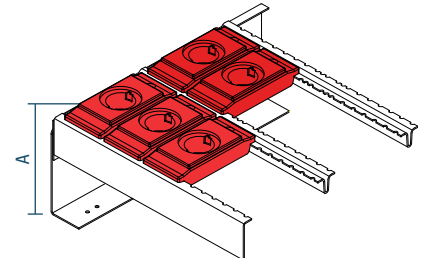

ORD. NO.

F NC 5220 00 01

Overall dim. mm 584x592x69 h

PAIR OF CARRIERS

ORD. NO.

DIMENSIONS mm

FOR HEIGHT TAPER mm REF. A

F NC 5650 00 01

594x86 h

A = 93 / 118 / 143

F NC 5840 00 01

594x136 h

A = 143 / 168 / 193

ORD. NO.
TOOL HOLDERS

TOOL HOLDER TYPE

MAX. QUANTITY PER TOOL FRAME
F NC 5020 00 ..

MAX. QUANTITY PER TOOL FRAME
F NC 5220 00 ..

F NC 9510 00 03	ISO 30	7	32
F NC 9530 00 03	ISO 40	7	32
F NC 9540 00 03	ISO 45	5	24
F NC 9550 00 03	ISO 50	5	20
F NC 9560 00 03	VDI 30	7	32
F NC 9570 00 03	VDI 40	5	24
F NC 9580 00 03	VDI 50	5	24
F NC 9590 00 03	VDI 60	5	20
F NC 9720 00 03	MORSE TAPER 2	7	32
F NC 9730 00 03	MORSE TAPER 3	7	32
F NC 9740 00 03	MORSE TAPER 4	7	32
F NC 9750 00 03	MORSE TAPER 5	5	24
F NC 9270 00 03	CAPTO C3	7	32
F NC 9275 00 03	CAPTO C4	5	24
F NC 9280 00 03	CAPTO C5	5	24

ORD. NO.
TOOL HOLDERS

TOOL HOLDER TYPE

MAX. QUANTITY PER TOOL FRAME
F NC 5020 00 ..

MAX. QUANTITY PER TOOL FRAME
F NC 5220 00 ..

F NC 9285 00 03	CAPTO C6	5	24
F NC 9290 00 03	CAPTO C8	4	16
F NC 9210 00 03	HSK A32-B40	7	32
F NC 9220 00 03	HSK A40-B50	7	32
F NC 9230 00 03	HSK A50-B63	5	24
F NC 9240 00 03	HSK A63-B80	5	24
F NC 9250 00 03	HSK A80-B100	4	16
F NC 9260 00 03	HSK A100-B125	4	16
F NC 9640 00 03	2"	5	24
F NC 9650 00 03	2" 1/4	5	20
F NC 9010 00 03	58 mm	9	36
F NC 9020 00 03	65 mm	8	32
F NC 9030 00 03	75 mm	7	28
F NC 9040 00 03	87 mm	6	24
F NC 9050 00 03	105 mm	5	20

■ Partitioning material see page A180

■ Partitioning material see page A96 - A97

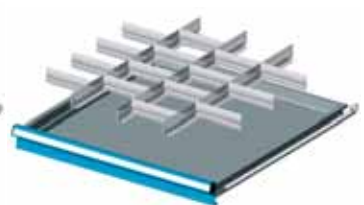
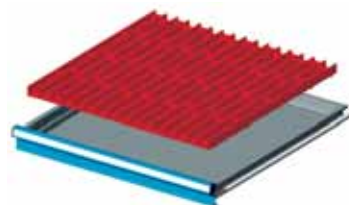
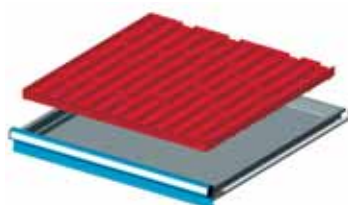
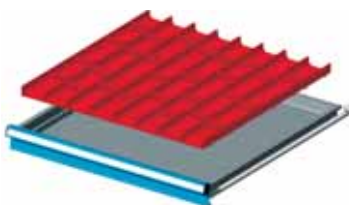

ORD. NO.

FOR FRONT HEIGHTS

F FH 2005 15 00

50-300

Set including:

16 Troughs 2 grooves
35 Plain partitions 73 mm

ORD. NO.

FOR FRONT HEIGHTS

F FH 2005 16 00

50-300

Set including:

16 Troughs 3 grooves
50 Plain partitions 47 mm

ORD. NO.

FOR FRONT HEIGHTS

F FH 2005 17 00

50-300

Set including:

16 Troughs 4 grooves
65 Plain partitions 36 mm

ORD. NO.

FOR FRONT HEIGHTS

F FH 2005 07 00

50

F FH 2007 07 00

75

F FH 2010 07 00

100-125

F FH 2015 07 00

150-175

F FH 2020 07 00

200-250

Set including:

3 Slotted partitions 610 mm
15 Plain partitions 149 mm