

EURO CONTAINERS



STACKING CONTAINERS SERIES **ATHENA** page A3



STACKING CONTAINERS SERIES **RLKLT** page B1



STACKING CONTAINERS SERIES **RKLT** page B11



STACKING CONTAINERS SERIES **ODETTE** page C1



STACKING CONTAINERS SERIES **THEMA** page D1





STACKING CONTAINERS SERIES **GOLD BOX** page E3



STACKING CONTAINERS SERIES **SECURITY - SHELL** page E5



STACKING CONTAINERS SERIES **NETTUNO** page F1



STACKING CONTAINERS SERIES **MINERVA** page G1



STACKING CONTAINERS SERIES **DELTA** page H1



STACKING CONTAINERS SERIES

ATHENA

Special care went into the design and production of the Athena series polypropylene stacking containers. The edges and reinforcements were studied to give the stacking containers a structure that can withstand the heaviest loads. The Athena series stacking containers in the standard colour can also be used in the food industry.

The bottom and the sides of the containers series Athena can be solid or perforated. The series also includes a version with an inspection window and even the handles can be open or closed. The diverse combinations of these elements allow eight possible solutions, shown in the table below, that optimally satisfy many market requirements.



lifting

walls

LifTiNG hole



SOLiD side walls



LifTiNG bar



PERFORATED side walls



bottoms

reinforced bottom



solid bottom



perforated bottom

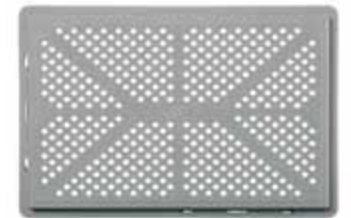

stacking container combinations

| A0 | B0 | C0 | D0 | E0 | F0 | S0 | R0 |
|----|----|----|----|----|----|----|----|
| | | | | | | | |
| | | | | | | | |
| | | | | | | | |

ATHENA

200x150 / 300x200

Made from **polypropylene**, the **Athena series 300x200** of stacking containers are the **perfect solution** for **storing small items**. They are available in **two different heights** and can be closed by the hinged cover.

OF GREY

| container ORD. NO. | A | B | C | D | E | F | G | H | I | L |
|--------------------|-----|-----|-----|-----|-----|-----|-----|-----|-----|-----|
| F PA 2251 A0 01 | 201 | 167 | 158 | 165 | 140 | 151 | 151 | 116 | 109 | 115 |
| container ORD. NO. | A | B | C | D | E | F | G | H | I | L |
| F PA 2451 A0 01 | 298 | 268 | 259 | 268 | 102 | 120 | 199 | 168 | 161 | 168 |
| F PA 2851 A0 01 | 298 | 267 | 259 | 267 | 151 | 170 | 198 | 166 | 160 | 167 |

A0 The technical data contained in the above table is approximate. FAMI S.r.l. reserves the right to make any modifications it sees fit to improve the performance and appearance of products. The manufacturer is not liable for any printing errors.

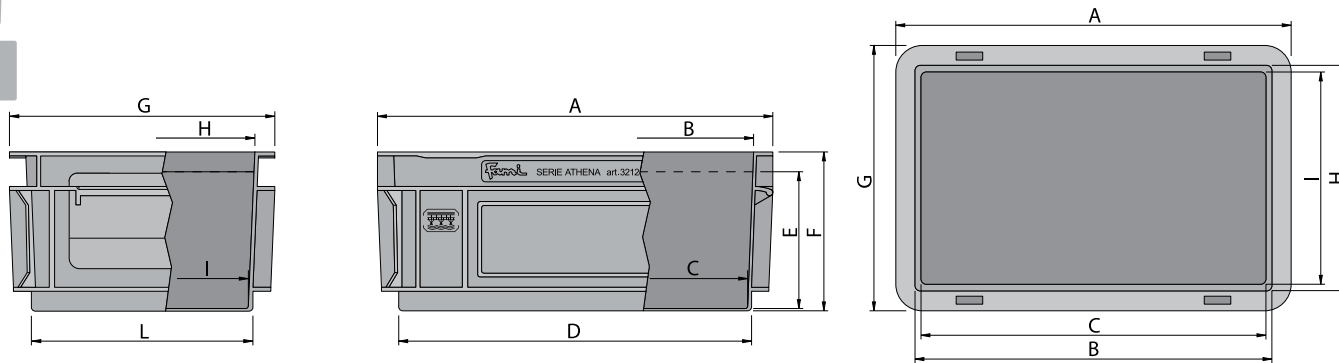

Detail of
**SOLID
BOTTOM**





SOLID BOTTOM



ORD. NO. F PA 2251 A0 01 -single

Measurements: 2115A

Standard colour: 01 grey ■

Weight gr.: 298

External nominal dim. mm: 200×150×150 h

Internal nominal dim. mm: 158×109×140 h

ORD. NO. FYA 2251 A0 01 -pallet

Weight of pallet kg: 152

Qty. Containers per pallet: 480 pcs.

Shipping dimensions mm: 1200×800×2280 h

ORD. NO. F PA 2451 A0 01 -single

Measurements: 3212A

Standard colour: 01 grey ■

Weight gr.: 432

External nominal dim. mm: 300×200×120 h

Internal nominal dim. mm: 259×161×102 h

ORD. NO. FYA 2451 A0 01 -pallet

Weight of pallet kg: 147

Qty. Containers per pallet: 320 pcs.

Shipping dimensions mm: 1200×800×2240 h



SOLID BOTTOM



ORD. NO. F PA 2851 A0 01 -single

Measurements: 3217A

Standard colour: 01 grey ■

Weight gr.: 616

External nominal dim. mm: 300×200×170 h

Internal nominal dim. mm: 259×160×151 h

ORD. NO. FYA 2851 A0 01 -pallet

Weight of pallet kg: 137

Qty. Containers per pallet: 208 pcs.

Shipping dimensions mm: 1200×800×2150 h



SOLID BOTTOM



ACCESSORIES
PAGE
A23

ATHENA 400x300

The **Athena** series container **400x300** mm are available in **6 models**, each with a **different height**. The **cover** can be **hinged, sliding or with a handle**.

OF GREY

| container ORD. NO. | A | B | C | D | E | F | G | H | I | L |
|--------------------|-----|-----|-----|-----|-----|-----|-----|-----|-----|-----|
| F PA 3251 A0 01 | 402 | 366 | 355 | 364 | 36 | 55 | 302 | 265 | 255 | 266 |
| F PA 3651 A0 01 | 400 | 369 | 355 | 365 | 57 | 75 | 300 | 268 | 255 | 267 |
| F PA 4051 A0 01 | 401 | 369 | 358 | 367 | 102 | 121 | 300 | 268 | 258 | 267 |
| F PA 4151 A0 01 | 402 | 369 | 358 | 366 | 94 | 121 | 300 | 268 | 253 | 265 |
| F PA 4051 E0 01 | 402 | 369 | 353 | 364 | 102 | 120 | 300 | 269 | 253 | 264 |
| F PA 4451 A0 01 | 402 | 370 | 358 | 367 | 152 | 171 | 300 | 268 | 258 | 268 |
| F PA 4551 A0 01 | 401 | 370 | 359 | 367 | 145 | 170 | 300 | 269 | 258 | 268 |
| F PA 4851 A0 01 | 401 | 370 | 358 | 367 | 202 | 221 | 301 | 270 | 258 | 268 |
| F PA 4851 B0 01 | 401 | 369 | 358 | 368 | 202 | 221 | 301 | 267 | 257 | 267 |
| F PA 4951 B0 01 | 401 | 370 | 358 | 364 | 195 | 221 | 301 | 270 | 258 | 264 |
| F PA 5251 A0 01 | 402 | 371 | 357 | 367 | 306 | 325 | 301 | 268 | 258 | 268 |
| F PA 5251 B0 01 | 401 | 369 | 357 | 367 | 305 | 324 | 300 | 268 | 257 | 267 |

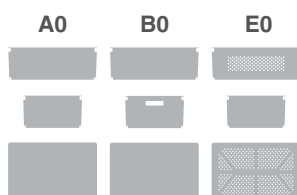

The technical data contained in the above table is approximate. FAMI S.r.l. reserves the right to make any modifications it sees fit to improve the performance and appearance of products. The manufacturer is not liable for any printing errors.

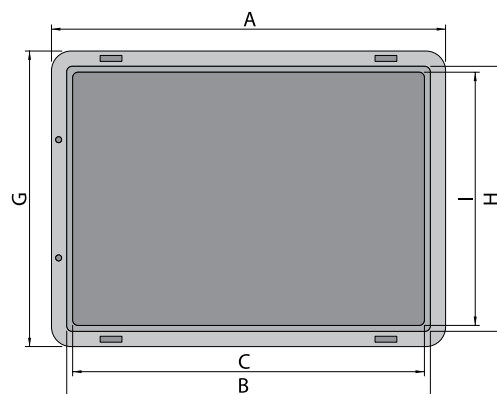
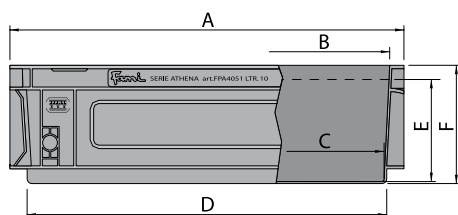
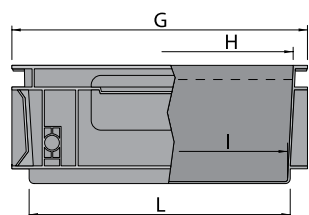

Detail of
SOLID
BOTTOM



Detail of
PERFORATED
BOTTOM



Detail of
REINFORCED
BOTTOM



*A reinforced bottom is available on all containers on request and with a minimum order quantity



SOLID BOTTOM

ORD. NO. F PA 3251 A0 01 -single

Measurements: 4305A

Standard colour: 01 grey ■

Weight gr.: 488

External nominal dim. mm: 400×300×55 h

Internal nominal dim. mm: 355×255×36 h

ORD. NO. F YA 3251 A0 01 -pallet

Weight of pallet kg: 165

Qty. Containers per pallet: 320 pcs.

Shipping dimensions mm: 1200×800×1730 h



SOLID BOTTOM

ORD. NO. F PA 3651 A0 01 -single

Measurements: 4308A

Standard colour: 01 grey ■

Weight gr.: 516

External nominal dim. mm: 400×300×75 h

Internal nominal dim. mm: 355×255×57 h

ORD. NO. F YA 3651 A0 01 -pallet

Weight of pallet kg: 133

Qty. Containers per pallet: 240 pcs.

Shipping dimensions mm: 1200×800×1960 h

ACCESSORIES
PAGE
A25



SOLID BOTTOM

ORD. NO. F PA 4051 A0 01 -single

Measurements: 4312A

Standard colour: 01 grey ■

Weight gr.: 782

External nominal dim. mm: 400×300×120 h

Internal nominal dim. mm: 358×258×102 h

ORD. NO. F YA 4051 A0 01 -pallet

Weight of pallet kg: 134

Qty. Containers per pallet: 160 pcs.

Shipping dimensions mm: 1200×800×2230 h



REINFORCED BOTTOM

ORD. NO. F PA 4151 A0 01 -single

Measurements: 4312A FR

Standard colour: 01 grey ■

Weight gr.: 876

External nominal dim. mm: 400×300×120 h

Internal nominal dim. mm: 358×253×94 h

ORD. NO. F YA 4151 A0 01 -pallet

Weight of pallet kg: 149

Qty. Containers per pallet: 160 pcs.

Shipping dimensions mm: 1200×800×2230 h



ORD. NO. F PA 4051 E0 01 -single

Measurements: 4312E

Standard colour: 01 grey ■

Weight gr.: 736

External nominal dim. mm: 400×300×120 h

Internal nominal dim. mm: 353×253×102 h

ORD. NO. F YA 4051 E0 01 -pallet

Weight of pallet kg: 127

Qty. Containers per pallet: 160 pcs.

Shipping dimensions mm: 1200×800×2230 h



ORD. NO. F PA 4451 A0 01 -single

Measurements: 4317A

Standard colour: 01 grey ■

Weight gr.: 1042

External nominal dim. mm: 400×300×170 h

Internal nominal dim. mm: 358×258×152 h

ORD. NO. F YA 4451 A0 01 -pallet

Weight of pallet kg: 117

Qty. Containers per pallet: 104 pcs.

Shipping dimensions mm: 1200×800×2150 h

PERFORATED BOTTOM



SOLID BOTTOM



ACCESSORIES
PAGE
A25





REINFORCED BOTTOM



ORD. NO. F PA 4551 A0 01 -single

| | |
|------------------|-----------|
| Measurements: | 4317A FR |
| Standard colour: | 01 grey ■ |

| | |
|---------------------------|---------------|
| Weight gr.: | 1108 |
| External nominal dim. mm: | 400×300×170 h |
| Internal nominal dim. mm: | 359×258×145 h |

ORD. NO. F YA 4551 A0 01 -pallet

| | |
|-----------------------------|-----------------|
| Weight of pallet kg: | 124 |
| Qty. Containers per pallet: | 104 pcs. |
| Shipping dimensions mm: | 1200×800×2150 h |



SOLID BOTTOM



ORD. NO. F PA 4851 A0 01 -single

| | |
|------------------|-----------|
| Measurements: | 4322A |
| Standard colour: | 01 grey ■ |

| | |
|---------------------------|---------------|
| Weight gr.: | 1284 |
| External nominal dim. mm: | 400×300×220 h |
| Internal nominal dim. mm: | 358×258×202 h |

ORD. NO. F YA 4851 A0 01 -pallet

| | |
|-----------------------------|-----------------|
| Weight of pallet kg: | 112 |
| Qty. Containers per pallet: | 80 pcs. |
| Shipping dimensions mm: | 1200×800×2200 h |



SOLID BOTTOM



ORD. NO. F PA 4851 B0 01 -single

| | |
|------------------|-----------|
| Measurements: | 4322B |
| Standard colour: | 01 grey ■ |

| | |
|---------------------------|---------------|
| Weight gr.: | 1230 |
| External nominal dim. mm: | 400×300×220 h |
| Internal nominal dim. mm: | 358×257×202 h |

ORD. NO. F YA 4851 B0 01 -pallet

| | |
|-----------------------------|-----------------|
| Weight of pallet kg: | 107 |
| Qty. Containers per pallet: | 80 pcs. |
| Shipping dimensions mm: | 1200×800×2200 h |



REINFORCED BOTTOM



ORD. NO. F PA 4951 B0 01 -single

| | |
|------------------|-----------|
| Measurements: | 4322B FR |
| Standard colour: | 01 grey ■ |

| | |
|---------------------------|---------------|
| Weight gr.: | 1330 |
| External nominal dim. mm: | 400×300×220 h |
| Internal nominal dim. mm: | 358×258×195 h |

ORD. NO. F YA 4951 B0 01 -pallet

| | |
|-----------------------------|-----------------|
| Weight of pallet kg: | 115 |
| Qty. Containers per pallet: | 80 pcs. |
| Shipping dimensions mm: | 1200×800×2200 h |



SOLID BOTTOM



ORD. NO. F PA 5251 A0 01 -single

| | |
|------------------|-----------|
| Measurements: | 4332A |
| Standard colour: | 01 grey ■ |

| | |
|---------------------------|---------------|
| Weight gr.: | 1852 |
| External nominal dim. mm: | 400×300×325 h |
| Internal nominal dim. mm: | 357×258×306 h |

ORD. NO. F YA 5251 A0 01 -pallet

| | |
|-----------------------------|-----------------|
| Weight of pallet kg: | 113 |
| Qty. Containers per pallet: | 56 pcs. |
| Shipping dimensions mm: | 1200×800×2300 h |



SOLID BOTTOM



ORD. NO. F PA 5251 B0 01 -single

| | |
|------------------|-----------|
| Measurements: | 4332B |
| Standard colour: | 01 grey ■ |

| | |
|---------------------------|---------------|
| Weight gr.: | 1728 |
| External nominal dim. mm: | 400×300×325 h |
| Internal nominal dim. mm: | 357×257×305 h |

ORD. NO. F YA 5251 B0 01 -pallet

| | |
|-----------------------------|-----------------|
| Weight of pallet kg: | 106 |
| Qty. Containers per pallet: | 56 pcs. |
| Shipping dimensions mm: | 1200×800×2300 h |

ATHENA 600x400

The **Athena** series containers **600x400** are manufactured in **multiple versions**, suitable for **every need**: Open or closed handgrips, solid or perforated bottom and sides, inspection window on the side (only for **F PA 8051 S0 01**) and the end (only for **F PA 8051 R0 01**).

Available **accessories**: Covers, **dividers** and **internal containers**.



OF GREY

| container ORD. NO. | A | B | C | D | E | F | G | H | I | L | M |
|--------------------|-----|-----|-----|-----|-----|-----|-----|-----|-----|-----|-----|
| F PA 5651 A0 01 | 602 | 566 | 555 | 563 | 58 | 77 | 404 | 366 | 355 | 364 | 606 |
| F PA 6051 A0 01 | 601 | 569 | 558 | 567 | 101 | 121 | 402 | 369 | 356 | 366 | 601 |
| F PA 6151 A0 01 | 602 | 570 | 554 | 565 | 95 | 121 | 402 | 370 | 354 | 365 | 601 |
| F PA 6051 C0 01 | 601 | 569 | 557 | 566 | 102 | 121 | 402 | 370 | 357 | 366 | 601 |
| F PA 6051 E0 01 | 601 | 569 | 557 | 565 | 101 | 120 | 401 | 369 | 356 | 365 | 601 |
| F PA 6451 A0 01 | 603 | 570 | 556 | 567 | 151 | 171 | 402 | 369 | 357 | 366 | 603 |
| F PA 6551 A0 01 | 602 | 571 | 559 | 566 | 137 | 171 | 402 | 370 | 359 | 365 | 601 |
| F PA 6851 A0 01 | 602 | 570 | 557 | 567 | 201 | 221 | 402 | 369 | 356 | 366 | 603 |
| F PA 6851 B0 01 | 601 | 568 | 556 | 566 | 201 | 221 | 401 | 370 | 356 | 366 | 604 |
| F PA 6951 B0 01 | 602 | 571 | 558 | 567 | 186 | 222 | 405 | 371 | 357 | 367 | 607 |
| F PA 6851 F0 01 | 602 | 570 | 555 | 564 | 199 | 221 | 401 | 370 | 355 | 364 | 605 |
| F PA 7251 A0 01 | 603 | 571 | 556 | 565 | 262 | 281 | 401 | 370 | 357 | 365 | 608 |
| F PA 7251 B0 01 | 600 | 569 | 556 | 565 | 262 | 280 | 400 | 369 | 356 | 364 | 605 |
| F PA 7351 B0 01 | 603 | 572 | 558 | 566 | 251 | 281 | 401 | 369 | 357 | 365 | 603 |
| F PA 7651 A0 01 | 603 | 571 | 558 | 566 | 307 | 326 | 402 | 371 | 356 | 365 | 603 |
| F PA 7651 B0 01 | 602 | 570 | 557 | 567 | 307 | 326 | 402 | 371 | 357 | 365 | 607 |
| F PA 7751 B0 01 | 603 | 570 | 558 | 567 | 294 | 328 | 402 | 371 | 358 | 367 | 608 |
| F PA 7651 D0 01 | 602 | 570 | 558 | 567 | 307 | 326 | 402 | 371 | 358 | 366 | 605 |
| F PA 8051 B0 01 | 603 | 573 | 558 | 568 | 413 | 431 | 401 | 370 | 358 | 367 | 603 |
| F PA 8051 D0 01 | 603 | 573 | 558 | 566 | 411 | 430 | 401 | 368 | 358 | 366 | 605 |
| F PA 8051 S0 01 | 602 | 572 | 557 | 566 | 411 | 430 | 401 | 369 | 356 | 365 | 601 |
| F PA 8051 R0 01 | 603 | 573 | 558 | 567 | 412 | 431 | 401 | 370 | 358 | 366 | 602 |

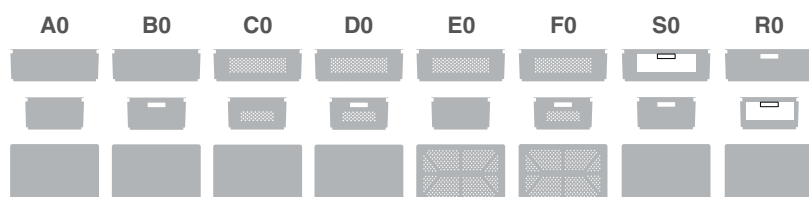

The technical data contained in the above table is approximate. FAMI S.r.l. reserves the right to make any modifications it sees fit to improve the performance and appearance of products. The manufacturer is not liable for any printing errors.

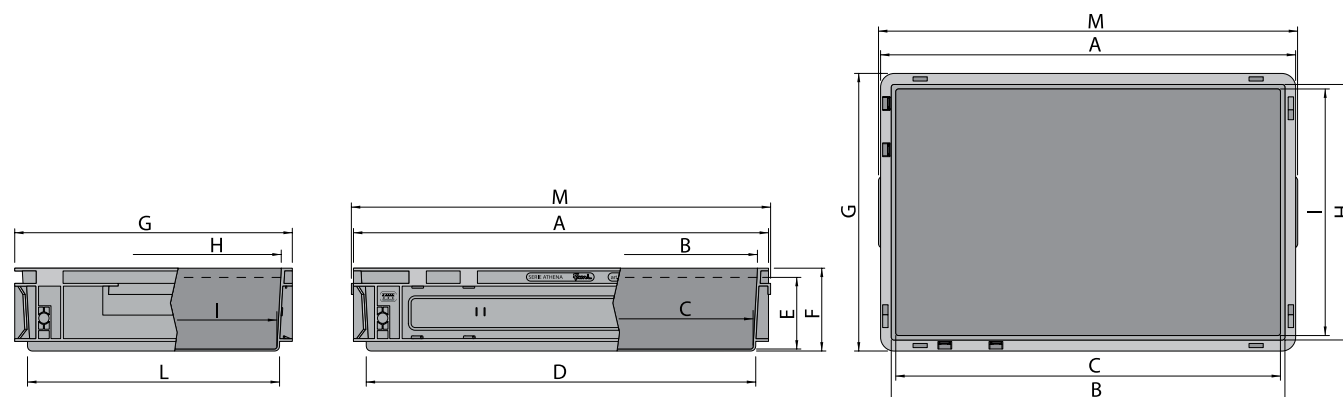

*A reinforced bottom is available on all containers on request and with a minimum order quantity



SOLID BOTTOM

ORD. NO. F PA 5651 A0 01 -single

Measurements: 6408A

Standard colour: 01 grey ■

Weight gr.: 1312

External nominal dim. mm: 600×400×75 h

Internal nominal dim. mm: 555×355×58 h

ORD. NO. F YA 5651 A0 01 -pallet

Weight of pallet kg: 166

Qty. Containers per pallet: 120 pcs.

Shipping dimensions mm: 1200×800×1970 h



SOLID BOTTOM

ORD. NO. F PA 6051 A0 01 -single

Measurements: 6412A

Standard colour: 01 grey ■

Weight gr.: 1636

External nominal dim. mm: 600×400×120 h

Internal nominal dim. mm: 558×356×101 h

ORD. NO. F YA 6051 A0 01 -pallet

Weight of pallet kg: 140

Qty. Containers per pallet: 80 pcs.

Shipping dimensions mm: 1200×800×2240 h



REINFORCED BOTTOM



ORD. NO. F PA 6151 A0 01 -single

Measurements: 6412A FR
Standard colour: 01 grey ■

Weight gr.: 1690
External nominal dim. mm: 600×400×120 h
Internal nominal dim. mm: 554×354×95 h

ORD. NO. F YA 6151 A0 01 -pallet

Weight of pallet kg: 144
Qty. Containers per pallet: 80 pcs.
Shipping dimensions mm: 1200×800×2240 h



SOLID BOTTOM



ORD. NO. F PA 6051 C0 01 -single

Measurements: 6412C
Standard colour: 01 grey ■

Weight gr.: 1624
External nominal dim. mm: 600×400×120 h
Internal nominal dim. mm: 557×357×102 h

ORD. NO. F YA 6051 C0 01 -pallet

Weight of pallet kg: 139
Qty. Containers per pallet: 80 pcs.
Shipping dimensions mm: 1200×800×2240 h



PERFORATED BOTTOM



ORD. NO. F PA 6051 E0 01 -single

Measurements: 6412E
Standard colour: 01 grey ■

Weight gr.: 1460
External nominal dim. mm: 600×400×120 h
Internal nominal dim. mm: 557×356×101 h

ORD. NO. F YA 6051 E0 01 -pallet

Weight of pallet kg: 126
Qty. Containers per pallet: 80 pcs.
Shipping dimensions mm: 1200×800×2240 h



SOLID BOTTOM



ORD. NO. F PA 6451 A0 01 -single

Measurements: 6417A
Standard colour: 01 grey ■

Weight gr.: 2134
External nominal dim. mm: 600×400×170 h
Internal nominal dim. mm: 556×357×151 h

ORD. NO. F YA 6451 A0 01 -pallet

Weight of pallet kg: 129
Qty. Containers per pallet: 56 pcs.
Shipping dimensions mm: 1200×800×2330 h



REINFORCED BOTTOM



ORD. NO. F PA 6551 A0 01 -single

Measurements: 6417A FR
Standard colour: 01 grey ■

Weight gr.: 2266
External nominal dim. mm: 600×400×170 h
Internal nominal dim. mm: 559×359×137 h

ORD. NO. F YA 6551 A0 01 -pallet

Weight of pallet kg: 136
Qty. Containers per pallet: 56 pcs.
Shipping dimensions mm: 1200×800×2330 h



SOLID BOTTOM



ORD. NO. F PA 6851 A0 01 -single

Measurements: 6422A
Standard colour: 01 grey ■

Weight gr.: 2586
External nominal dim. mm: 600×400×220 h
Internal nominal dim. mm: 557×356×201 h

ORD. NO. F YA 6851 A0 01 -pallet

Weight of pallet kg: 112
Qty. Containers per pallet: 40 pcs.
Shipping dimensions mm: 1200×800×2200 h



SOLID BOTTOM

ORD. NO. F PA 6851 B0 01 -single

Measurements: 6422B

Standard colour: 01 grey ■

Weight gr.: 2518

External nominal dim. mm: 600x400x220 h

Internal nominal dim. mm: 556x356x201 h

ORD. NO. F YA 6851 B0 01 -pallet

Weight of pallet kg: 110

Qty. Containers per pallet: 40 pcs.

Shipping dimensions mm: 1200x800x2200 h



REINFORCED BOTTOM

ORD. NO. F PA 6951 B0 01 -single

Measurements: 6422B FR

Standard colour: 01 grey ■

Weight gr.: 2666

External nominal dim. mm: 600x400x220 h

Internal nominal dim. mm: 558x357x186 h

ORD. NO. F YA 6951 B0 01 -pallet

Weight of pallet kg: 116

Qty. Containers per pallet: 40 pcs.

Shipping dimensions mm: 1200x800x2200 h



PERFORATED BOTTOM

ORD. NO. F PA 6851 F0 01 -single

Measurements: 6422F

Standard colour: 01 grey ■

Weight gr.: 2424

External nominal dim. mm: 600x400x220 h

Internal nominal dim. mm: 555x355x199 h

ORD. NO. F YA 6851 F0 01 -pallet

Weight of pallet kg: 106

Qty. Containers per pallet: 40 pcs.

Shipping dimensions mm: 1200x800x2200 h



SOLID BOTTOM

ORD. NO. F PA 7251 A0 01 -single

Measurements: 6428A

Standard colour: 01 grey ■

Weight gr.: 2866

External nominal dim. mm: 600x400x280 h

Internal nominal dim. mm: 556x357x262 h

ORD. NO. F YA 7251 A0 01 -pallet

Weight of pallet kg: 101

Qty. Containers per pallet: 32 pcs.

Shipping dimensions mm: 1200x800x2270 h



ACCESSORIES
PAGE
A29
VIMAR



SOLID BOTTOM



ORD. NO. F PA 7251 B0 01 -single

Measurements: 6428B

Standard colour: 01 grey ■

Weight gr.: 2762

External nominal dim. mm: 600×400×280 h

Internal nominal dim. mm: 556×356×262 h

ORD. NO. F YA 7251 B0 01 -pallet

Weight of pallet kg: 97

Qty. Containers per pallet: 32 pcs.

Shipping dimensions mm: 1200×800×2270 h

ORD. NO. F PA 7351 B0 01 -single

Measurements: 6428B FR

Standard colour: 01 grey ■

Weight gr.: 2968

External nominal dim. mm: 600×400×280 h

Internal nominal dim. mm: 558×357×251 h

ORD. NO. F YA 7351 B0 01 -pallet

Weight of pallet kg: 104

Qty. Containers per pallet: 32 pcs.

Shipping dimensions mm: 1200×800×2270 h



REINFORCED BOTTOM



ORD. NO. F PA 7651 A0 01 -single

Measurements: 6432A

Standard colour: 01 grey ■

Weight gr.: 3170

External nominal dim. mm: 600×400×325 h

Internal nominal dim. mm: 558×356×307 h

ORD. NO. F YA 7651 A0 01 -pallet

Weight of pallet kg: 98

Qty. Containers per pallet: 28 pcs.

Shipping dimensions mm: 1200×800×2300 h



SOLID BOTTOM



ACCESSORIES
PAGE
A29



SOLID BOTTOM



ORD. NO. F PA 7651 B0 01 **-single**

Measurements: 6432B

Standard colour: 01 grey ■

Weight gr.: 3228

External nominal dim. mm: 600×400×325 h

Internal nominal dim. mm: 557×357×307 h

ORD. NO. FYA 7651 B0 01 **-pallet**

Weight of pallet kg: 99

Qty. Containers per pallet: 28 pcs.

Shipping dimensions mm: 1200×800×2300 h



REINFORCED BOTTOM



ORD. NO. F PA 7751 B0 01 **-single**

Measurements: 6432B FR

Standard colour: 01 grey ■

Weight gr.: 3500

External nominal dim. mm: 600×400×325 h

Internal nominal dim. mm: 558×358×294 h

ORD. NO. FYA 7751 B0 01 **-pallet**

Weight of pallet kg: 107

Qty. Containers per pallet: 28 pcs.

Shipping dimensions mm: 1200×800×2300 h



SOLID BOTTOM



ORD. NO. F PA 7651 D0 01 **-single**

Measurements: 6432D

Standard colour: 01 grey ■

Weight gr.: 2968

External nominal dim. mm: 600×400×325 h

Internal nominal dim. mm: 558×358×307 h

ORD. NO. FYA 7651 D0 01 **-pallet**

Weight of pallet kg: 92

Qty. Containers per pallet: 28 pcs.

Shipping dimensions mm: 1200×800×2300 h



SOLID BOTTOM



ORD. NO. F PA 8051 B0 01 -single

Measurements: 6443B

Standard colour: 01 grey ■

Weight gr.: 3752

External nominal dim. mm: 600×400×430 h

Internal nominal dim. mm: 558×358×413 h

ORD. NO. F YA 8051 B0 01 -pallet

Weight of pallet kg: 84

Qty. Containers per pallet: 20 pcs.

Shipping dimensions mm: 1200×800×2200 h



SOLID BOTTOM



ORD. NO. F PA 8051 D0 01 -single

Measurements: 6443D

Standard colour: 01 grey ■

Weight gr.: 3502

External nominal dim. mm: 600×400×430 h

Internal nominal dim. mm: 558×358×411 h

ORD. NO. F YA 8051 D0 01 -pallet

Weight of pallet kg: 79

Qty. Containers per pallet: 20 pcs.

Shipping dimensions mm: 1200×800×2200 h



SOLID BOTTOM



ORD. NO. F PA 8051 S0 01 -single

Measurements: 6443S

Standard colour: 01 grey ■

Weight gr.: 3626

External nominal dim. mm: 600×400×430 h

Internal nominal dim. mm: 557×356×411 h

ORD. NO. F YA 8051 S0 01 -pallet

Weight of pallet kg: 82

Qty. Containers per pallet: 20 pcs.

Shipping dimensions mm: 1200×800×2200 h



SOLID BOTTOM



ORD. NO. F PA 8051 R0 01 **-single**

Measurements: 6443R

Standard colour: 01 grey ■

Weight gr.: 3746

External nominal dim. mm: 600×400×430 h

Internal nominal dim. mm: 558×358×412 h

ORD. NO. F YA 8051 R0 01 **-pallet**

Weight of pallet kg: 84

Qty. Containers per pallet: 20 pcs.

Shipping dimensions mm: 1200×800×2200 h



ATHENA

800x600

Ideal for **containing** and **storing bulky material**, the series **Athena** stacking containers are available in the standard **800x600** size with **5 various heights**.

OF GREY

| container ORD. NO. | A | B | C | D | E | F | G | H | I | L | M |
|--------------------|-----|-----|-----|-----|-----|-----|-----|-----|-----|-----|-----|
| F PA 8551 A0 01 | 804 | 770 | 755 | 764 | 85 | 121 | 605 | 568 | 554 | 563 | 824 |
| F PA 8751 A0 01 | 803 | 769 | 754 | 763 | 135 | 173 | 602 | 568 | 554 | 563 | 818 |
| F PA 8951 A0 01 | 805 | 770 | 755 | 764 | 186 | 222 | 603 | 567 | 554 | 562 | 820 |
| F PA 9351 A0 01 | 804 | 771 | 756 | 764 | 293 | 329 | 603 | 569 | 554 | 563 | 820 |
| F PA 9751 A0 01 | 803 | 770 | 755 | 763 | 392 | 429 | 602 | 568 | 553 | 562 | 817 |

A0 The technical data contained in the above table is approximate. FAMI S.r.l. reserves the right to make any modifications it sees fit to improve the performance and appearance of products. The manufacturer is not liable for any printing errors.

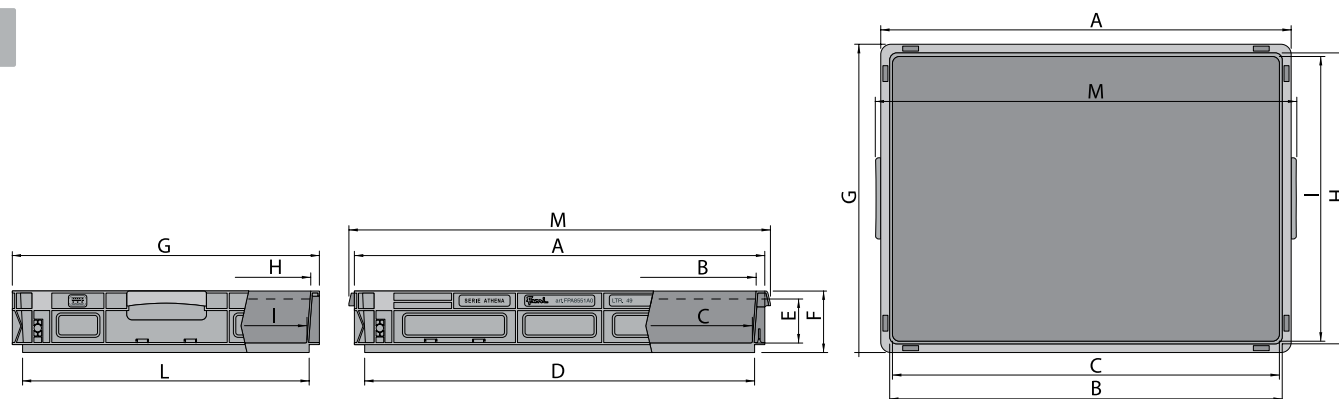

Detail of
**REINFORCED
BOTTOM**

*A smooth bottom is available on all containers on request and with a minimum order quantity





REINFORCED BOTTOM



ORD. NO. F PA 8551 A0 01 -single

Measurements: 8612A FR
Standard colour: 01 grey ■

Weight gr.: 3458
External nominal dim. mm: 800×600×120 h
Internal nominal dim. mm: 755×554×85 h

ORD. NO. F YA 8551 A0 01 -pallet

Weight of pallet kg: 147
Qty. Containers per pallet: 40 pcs.
Shipping dimensions mm: 1200×800×2300 h



REINFORCED BOTTOM

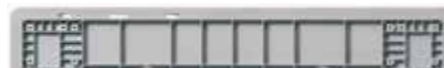

ORD. NO. F PA 8751 A0 01 -single

Measurements: 8617A FR
Standard colour: 01 grey ■

Weight gr.: 3804
External nominal dim. mm: 800×600×170 h
Internal nominal dim. mm: 754×554×135 h

ORD. NO. F YA 8751 A0 01 -pallet

Weight of pallet kg: 116
Qty. Containers per pallet: 28 pcs.
Shipping dimensions mm: 1200×800×2300 h



REINFORCED BOTTOM



ORD. NO. F PA 8951 A0 01 -single

Measurements: 8622A FR
Standard colour: 01 grey ■

Weight gr.: 4588
External nominal dim. mm: 800×600×220 h
Internal nominal dim. mm: 755×554×186 h

ORD. NO. F YA 8951 A0 01 -pallet

Weight of pallet kg: 101
Qty. Containers per pallet: 20 pcs.
Shipping dimensions mm: 1200×800×2200 h



REINFORCED BOTTOM



ORD. NO. F PA 9351 A0 01 -single

Measurements: 8632A FR
Standard colour: 01 grey ■

Weight gr.: 5422
External nominal dim. mm: 800×600×325 h
Internal nominal dim. mm: 756×554×293 h

ORD. NO. F YA 9351 A0 01 -pallet

Weight of pallet kg: 85
Qty. Containers per pallet: 14 pcs.
Shipping dimensions mm: 1200×800×2320 h



ACCESSORIES
PAGE
A33



REINFORCED BOTTOM

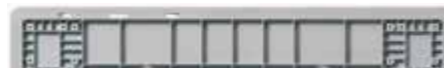

ORD. NO. F PA 9751 A0 01 -single

Measurements: 8643A FR
Standard colour: 01 grey ■

Weight gr.: 6238
External nominal dim. mm: 800×600×430 h
Internal nominal dim. mm: 755×553×392 h

ORD. NO. F YA 9751 A0 01 -pallet

Weight of pallet kg: 71
Qty. Containers per pallet: 10 pcs.
Shipping dimensions mm: 1200×800×2230 h

CONTAINER SUPPLIED ASSEMBLED

container including 1 set of four feet



| ORD. NO. | Dimensions mm | Capacity litres |
|----------------------------|---------------|-----------------|
| F PA 8551 AD 01 | 800x600x220 h | 49 |
| Measurements | 8612A-P | |
| With 120 mm high container | | |

| ORD. NO. | Dimensions mm | Capacity litres |
|----------------------------|---------------|-----------------|
| F PA 8751 AD 01 | 800x600x270 h | 69 |
| Measurements | 8617A-P | |
| With 170 mm high container | | |

| ORD. NO. | Dimensions mm | Capacity litres |
|----------------------------|---------------|-----------------|
| F PA 8951 AD 01 | 800x600x320 h | 90 |
| Measurements | 8622A-P | |
| With 220 mm high container | | |

| ORD. NO. | Dimensions mm | Capacity litres |
|----------------------------|---------------|-----------------|
| F PA 9351 AD 01 | 800x600x425 h | 130 |
| Measurements | 8632A-P | |
| With 325 mm high container | | |

| ORD. NO. | Dimensions mm | Capacity litres |
|----------------------------|---------------|-----------------|
| F PA 9751 AD 01 | 800x600x530 h | 175 |
| Measurements | 8643A-P | |
| With 430 mm high container | | |

container including 1 set of four feet and 1 pair of connection pieces



| ORD. NO. | Dimensions mm | Capacity litres |
|----------------------------|---------------|-----------------|
| F PA 8551 AE 01 | 800x600x245 h | 49 |
| Measurements | 8612A-T | |
| With 120 mm high container | | |

| ORD. NO. | Dimensions mm | Capacity litres |
|----------------------------|---------------|-----------------|
| F PA 8751 AE 01 | 800x600x295 h | 69 |
| Measurements | 8617A-T | |
| With 170 mm high container | | |

| ORD. NO. | Dimensions mm | Capacity litres |
|----------------------------|---------------|-----------------|
| F PA 8951 AE 01 | 800x600x345 h | 90 |
| Measurements | 8622A-T | |
| With 220 mm high container | | |

| ORD. NO. | Dimensions mm | Capacity litres |
|----------------------------|---------------|-----------------|
| F PA 9351 AE 01 | 800x600x450 h | 130 |
| Measurements | 8632A-T | |
| With 325 mm high container | | |

| ORD. NO. | Dimensions mm | Capacity litres |
|----------------------------|---------------|-----------------|
| F PA 9751 AE 01 | 800x600x555 h | 175 |
| Measurements | 8643A-T | |
| With 430 mm high container | | |

container including 1 set of four Ø 100 mm rubber swivel wheels



| ORD. NO. | Dimensions mm | Capacity litres |
|----------------------------|---------------|-----------------|
| F PA 8551 AF 01 | 800x600x245 h | 49 |
| Measurements | 8612A-R | |
| With 120 mm high container | | |

| ORD. NO. | Dimensions mm | Capacity litres |
|----------------------------|---------------|-----------------|
| F PA 8751 AF 01 | 800x600x295 h | 69 |
| Measurements | 8617A-R | |
| With 170 mm high container | | |

| ORD. NO. | Dimensions mm | Capacity litres |
|----------------------------|---------------|-----------------|
| F PA 8951 AF 01 | 800x600x345 h | 90 |
| Measurements | 8622A-R | |
| With 220 mm high container | | |

| ORD. NO. | Dimensions mm | Capacity litres |
|----------------------------|---------------|-----------------|
| F PA 9351 AF 01 | 800x600x450 h | 130 |
| Measurements | 8632A-R | |
| With 325 mm high container | | |

| ORD. NO. | Dimensions mm | Capacity litres |
|----------------------------|---------------|-----------------|
| F PA 9751 AF 01 | 800x600x555 h | 175 |
| Measurements | 8643A-R | |
| With 430 mm high container | | |



The containers can be stacked thanks to the 4 feet which enter inside the container below



The 2 connection pieces allow the containers to be stacked



The containers can be stacked thanks to the 4 wheels which enter inside the container below



ACCESSORIES
ATHENA
300x200



LIDS



HINGED LID



| | |
|------------------------|---------------|
| ORD. NO. | Hinged lid mm |
| F PA 0351 00 01 | 300x200 |
| Weight gr. | 150 |

01 GREY

CLOSING SYSTEMS

The covers for the **Athena** series of stacking containers can be **closed** with **nylon kick-in locks**.



CLOSED
AND
SEALED

| | |
|------------------------|-------------------------------------------------------------|
| ORD. NO. | Pair of sliding hooks suitable for Athena series containers |
| F PZ 0681 00 13 | |

13 WHITE

METAL CLIPS

These metal clips can be **snapped** into the long or short sides of the **Athena** stacking containers and are used to **keep documents in place**.



| | |
|------------------------|----------|
| ORD. NO. | DIM. mm |
| F PZ 0010 00 99 | 75x20x20 |



example of **metal clip use**

SPECIAL LABELS

Page Q1



fitting the metal clip

99 HOT GALVANISED



A24

ACCESSORIES
ATHENA
400x300



LIDS



HINGED LID



LID WITH HANDLES



SLIDING LID

the cover cannot be used on containers in the shelving system F TR



| ORD. NO. | Hinged lid mm |
|-----------------|---------------|
| F PA 0651 00 01 | 400x300 |
| Weight gr. | 340 |

| ORD. NO. | Lid with handles mm |
|-----------------|---------------------|
| F PA 1B51 00 01 | 400x300 |
| Weight gr. | 322 |

| ORD. NO. | Sliding lid mm |
|-----------------|----------------|
| F PA 1651 00 01 | 400x300 |
| Weight gr. | 328 |

not suitable
for ORD. NO.
F PA 3251 A0 01

01 GREY

CLOSING SYSTEMS

The **covers** for the **Athena** series of stacking containers can be **closed** with **nylon kick-in locks**.



**CLOSED
AND
SEALED**

| ORD. NO. | Pair of sliding hooks suitable for Athena series containers |
|-----------------|-------------------------------------------------------------|
| F PZ 0681 00 13 | |

13 WHITE

LABEL HOLDER

On the **Athena** series containers, it is possible to **insert** labels attaching a **black polypropylene frame** in the available grooves. The **label holder** for the **Athena** series is available in **400x300** size with a **window**.



| ORD. NO. | DIM. mm |
|-----------------|---------|
| F PZ 9551 00 07 | 150x85 |

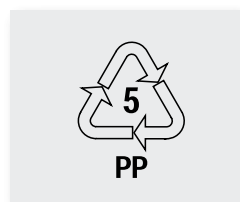

**EXCLUDING
Athena Ord. No.**

F PA 3251 A0 01 - F PA 3651 A0 01 - F PA 4051 A0 01
F PA 4151 A0 01 - F PA 4051 E0 01

SPECIAL LABELS

Page Q1

LABEL SHEET

| ORD. NO. | Label Dim. mm |
|---------------------|---------------|
| F PZ 0920 00 00 | 145x81 |
| Sheet with 4 labels | |

07 BLACK

A26

SUB-DIVIDING CONTAINERS

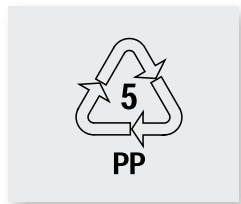

These **sub-dividing containers separate** the **Athena** series **400x300 mm** stacking containers into two or more compartments **as required**.

They are fitted with a **dust proof transparent cover** with a **grip for lifting** and which allows the containers to be stacked.



SUBDIVIDING CASES

| ORD. NO. | External DIM. mm |
|-----------------|------------------|
| F PP 4051 00 01 | 256x178x90 h |

| ORD. NO. | External DIM. mm |
|-----------------|------------------|
| F PP 4551 00 01 | 256x178x90 h |



| stacking container divided with |
|---------------------------------|
| 1 ORD. NO. F PP 4051 00 01 |
| 1 ORD. NO. F PP 4551 00 01 |



| stacking container divided with |
|---------------------------------|
| 1 ORD. NO. F PP 4051 00 01 |
| 1 ORD. NO. F PP 5051 00 01 |

| ORD. NO. | External DIM. mm |
|-----------------|------------------|
| F PP 5051 00 01 | 256x178x90 h |

| ORD. NO. | External DIM. mm |
|-----------------|------------------|
| F PP 9368 00 96 | 256x178 h |



| stacking container divided with |
|---------------------------------|
| 1 ORD. NO. F PP 4551 00 01 |
| 1 ORD. NO. F PP 5051 00 01 |

96 TRANSPARENT

OF GREY

METAL CLIPS

These metal clips can be **snapped** into the long or short sides of the **Athena** stacking containers and are used to **keep documents in place**.



| ORD. NO. | DIM. mm |
|-----------------|------------|
| F PZ 0010 00 99 | 75x20x20 h |

example of **metal clip use**

fitting the **metal clip**

SLOTTED PARTITIONS



In order to **arrange** and **protect** particularly delicate material or material that must not come into contact with other products when being **moved** and **stored**, Fami has designed and produced a **system for dividing** the stacking containers by means of **slotted partitions**. Made from **plastic** and available in **various sizes**, they feature **partitions slotted** in increments of 20 mm. They **divide the insides of stacking containers** in a rational and varied way **according to user requirements**.

height mm 45 h

height mm 70 h

height mm 90 h

height mm 120 h

height mm 180 h

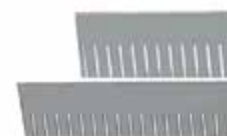

| ORD. NO. | DIM. mm | Increments mm |
|-----------------|---------|---------------|
| F HN 1320 00 01 | 255×45 | 20 |
| F HN 1420 00 01 | 355×45 | 20 |

| ORD. NO. | DIM. mm | Increments mm |
|-----------------|---------|---------------|
| F HN 1340 00 01 | 255×70 | 20 |
| F HN 1440 00 01 | 355×70 | 20 |

| ORD. NO. | DIM. mm | Increments mm |
|-----------------|---------|---------------|
| F HN 1350 00 01 | 255×90 | 20 |
| F HN 1450 00 01 | 355×90 | 20 |

| ORD. NO. | DIM. mm | Increments mm |
|-----------------|---------|---------------|
| F HN 1360 00 01 | 255×120 | 20 |
| F HN 1460 00 01 | 355×120 | 20 |

| ORD. NO. | DIM. mm | Increments mm |
|-----------------|---------|---------------|
| F HN 1370 00 01 | 255×180 | 20 |
| F HN 1470 00 01 | 355×180 | 20 |

COVER OR LAYER SEPARATOR

Made out of **plastic**, the **intermediate plate** acts as a **separator** if the container is **divided** into layers. The **lateral grooves** on the cover **make it easy to grip and lift**.



| ORD. NO. | DIM. mm |
|-----------------|---------|
| F HN 5130 00 01 | 355×255 |



01 GREY



ACCESSORIES
ATHENA
600x400



LIDS

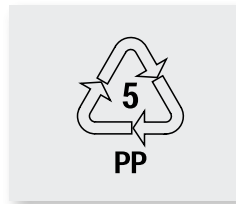

HINGED LID



LID WITH HANDLES



| | |
|------------------------|---------------|
| ORD. NO. | Hinged lid mm |
| F PA 0951 00 01 | 600×400 |
| Weight gr. | 700 |

| | |
|------------------------|---------------------|
| ORD. NO. | Lid with handles mm |
| F PA 1C51 00 01 | 600×400 |
| Weight gr. | 720 |

01 GREY

CLOSING SYSTEMS

The **covers** for the **Athena** series of stacking containers can be **closed** with **nylon kick-in locks**.



CLOSED AND SEALED

| | |
|------------------------|-------------------------------------------------------------|
| ORD. NO. | Pair of sliding hooks suitable for Athena series containers |
| F PZ 0681 00 13 | |

13 WHITE

LABEL HOLDER

On the **Athena** series containers, it is possible to **insert** labels attaching a **black polypropylene frame** in the available **grooves**. The **label holder** for the **Athena** series is available in **600×400** size with a **window**.

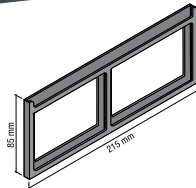

| | |
|------------------------|---------|
| ORD. NO. | DIM. mm |
| F PZ 9751 00 07 | 215×85 |

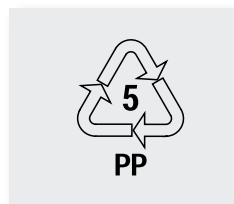

EXCLUDING Athena Ord. No.

F PA 5651 A0 01 - F PA 6051 A0 01 - F PA 6151 A0 01
F PA 6051 C0 01 - F PA 6051 E0 01

SPECIAL LABELS

PAGE Q1

LABEL SHEET

| | |
|------------------------|---------------------|
| ORD. NO. | Label Dim. mm |
| F PZ 0940 00 00 | 210×81 |
| | Sheet with 3 labels |

07 BLACK

A30

SUB-DIVIDING CONTAINERS



These **sub-dividing containers separate** the **Athena series 600x400 mm stacking containers** into two or more compartments but they can also be used **on their own to store material**. A handy **dust proof cover**, made from **transparent polystyrene**, is also available.



| ORD. NO. | External DIM. mm |
|-----------------|------------------|
| F PP 6051 00 01 | 357x278x90 h |

| ORD. NO. | External DIM. mm |
|-----------------|------------------|
| F PP 6551 00 01 | 357x278x90 h |



| ORD. NO. | External DIM. mm |
|-----------------|------------------|
| F PP 7051 00 01 | 357x278x90 h |

| ORD. NO. | External DIM. mm |
|-----------------|------------------|
| F PP 9668 00 96 | 357x278 h |

96 TRANSPARENT

ORD. NO. F PP 5551 00 01 - CONTAINER DIVIDER FOR THE ATHENA CONTAINER

SUBDIVIDING CASES



| stacking container divided with |
|---------------------------------|
| 1 ORD. NO. F PP 6051 00 01 |
| 1 ORD. NO. F PP 6551 00 01 |



| stacking container divided with |
|---------------------------------|
| 1 ORD. NO. F PP 6051 00 01 |
| 1 ORD. NO. F PP 7051 00 01 |



| stacking container divided with |
|---------------------------------|
| 1 ORD. NO. F PP 6551 00 01 |
| 1 ORD. NO. F PP 7051 00 01 |



| ORD. NO. | External DIM. mm |
|-----------------|------------------|
| F PP 5551 00 01 | 277x177x99 h |



01 GREY

METAL CLIPS

These metal clips can be **snapped** into the long or short sides of the **Athena stacking containers** and are used to **keep documents in place**.



| ORD. NO. | DIM. mm |
|-----------------|----------|
| F PZ 0010 00 99 | 75x20x20 |

example of **metal clip use**

fitting the **metal clip**

SLOTTED PARTITIONS



In order to **arrange** and **protect** particularly delicate material or material that must not come into contact with other products when being **moved** and **stored**, Fami has designed and produced a **system for dividing** the stacking containers by means of **slotted partitions**. Made from **plastic** and available in **various sizes**, they feature **partitions slotted** in increments of 20 mm. They **divide the insides of stacking containers** in a rational and varied way **according to user requirements**.

height mm 45 h

height mm 70 h

height mm 90 h

height mm 120 h

height mm 180 h

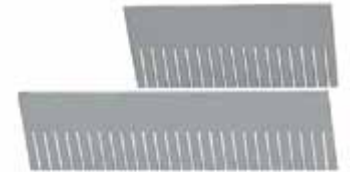

| ORD. NO. | DIM. mm | Increments mm |
|-----------------|---------|---------------|
| F HN 1420 00 01 | 355×45 | 20 |
| F HN 1620 00 01 | 555×45 | 20 |

| ORD. NO. | DIM. mm | Increments mm |
|-----------------|---------|---------------|
| F HN 1440 00 01 | 355×70 | 20 |
| F HN 1640 00 01 | 555×70 | 20 |

| ORD. NO. | DIM. mm | Increments mm |
|-----------------|---------|---------------|
| F HN 1450 00 01 | 355×90 | 20 |
| F HN 1650 00 01 | 555×90 | 20 |

| ORD. NO. | DIM. mm | Increments mm |
|-----------------|---------|---------------|
| F HN 1460 00 01 | 355×120 | 20 |
| F HN 1660 00 01 | 555×120 | 20 |

| ORD. NO. | DIM. mm | Increments mm |
|-----------------|---------|---------------|
| F HN 1470 00 01 | 355×180 | 20 |
| F HN 1670 00 01 | 555×180 | 20 |

COVER OR LAYER SEPARATOR

Made out of **plastic**, the **intermediate plate** acts as a **separator** if the container is **divided** into layers. The **lateral grooves** on the cover **make it easy to grip and lift**.

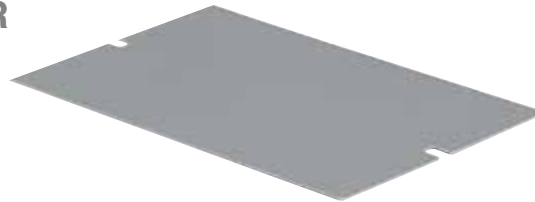

| ORD. NO. | DIM. mm |
|-----------------|---------|
| F HN 5140 00 01 | 555×355 |



DIVIDERS WITH SUPPORTS



| ORD. NO. | DIM. mm |
|-----------------|---------|
| F ND 0340 01 99 | 195 h |

For Athena stacking containers Ord. no. **F PA 6851....**



| ORD. NO. | DIM. mm |
|-----------------|---------|
| F ND 0330 01 99 | 145 h |

For Athena stacking containers Ord. no. **F PA 6451 A0 01**

extra front-to-back divider

| ORD. NO. | Extra front-to-back divider for Ord. no. F ND 0340 01 99 |
|-----------------|----------------------------------------------------------|
| F ND 0340 00 99 | |

| ORD. NO. | Extra front-to-back divider for Ord. no. F ND 0330 01 99 |
|-----------------|----------------------------------------------------------|
| F ND 0330 00 99 | |



ACCESSORIES
ATHENA
800x600



LIDS

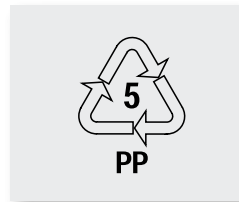

LID WITH HANDLES



| | |
|------------------------|---------------------|
| ORD. NO. | Lid with handles mm |
| F PA 1251 01 01 | 800x600 |
| Weight gr. | 1978 |

01 GREY

LABEL HOLDER

On the **Athena** series containers, it is possible to **insert** labels attaching a **black polypropylene frame** in the available **grooves**. The **label holder** for the **Athena** series is available in **400x300** format with a **window**.

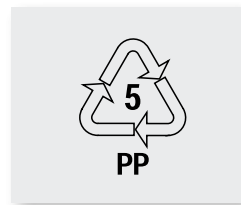
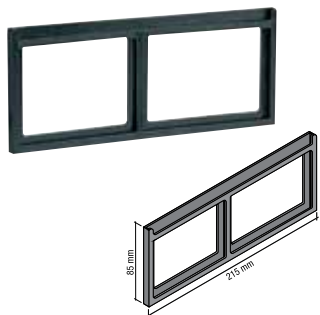

EXCLUDING
Athena Ord. No.

F PA 8551 A0 01

| | |
|------------------------|---------|
| ORD. NO. | DIM. mm |
| F PZ 9751 00 07 | 215x85 |



LABEL SHEET

| | |
|------------------------|---------------|
| ORD. NO. | Label Dim. mm |
| F PZ 0940 00 00 | 210x81 |
| Sheet with 3 labels | |

07 BLACK

METAL CLIPS

These metal clips can be **snapped** into the long or short sides of the **Athena** stacking containers and are used to **keep documents in place**.



| | |
|------------------------|----------|
| ORD. NO. | DIM. mm |
| F PZ 0010 00 99 | 75x20x20 |

example of **metal clip** use

fitting the **metal clip**

99 HOT GALVANISED

CASTORS

standard rubber

swivel with brake

fixed

swivel without brake



| SWIVEL CASTOR WITH BRAKE | Ø mm |
|--------------------------|------|
| C RG DAC11 100 | 100 |
| C RG DAC12 125 | 125 |

| FIXED CASTOR | Ø mm |
|----------------|------|
| C RG BAC11 100 | 100 |
| C RG BAC12 125 | 125 |

| SWIVEL CASTOR WITHOUT BRAKE | Ø mm |
|-----------------------------|------|
| C RG CAC11 100 | 100 |
| C RG CAC12 125 | 125 |

nylon

swivel with brake

fixed



| SWIVEL CASTOR WITH BRAKE | Ø mm |
|--------------------------|------|
| C RN DAD10 100 | 100 |
| C RN DAD11 125 | 125 |

| FIXED CASTOR | Ø mm |
|----------------|------|
| C RN BAD10 100 | 100 |
| C RN BAD11 125 | 125 |

synthetic mark-proof rubber

swivel with brake

fixed



| SWIVEL CASTOR WITH BRAKE | Ø mm |
|--------------------------|------|
| C RG DPH22 125 | 125 |

| FIXED CASTOR | Ø mm |
|----------------|------|
| C RG BPH22 125 | 125 |

Set of 16 screws to secure the castors to the container.
Ord. No. F PZ 8800 00 00



FEET



Set of 4 feet
Ord. No. F PZ 8751 01 01
Dim. 105x85x112 mm h
Supplied with screws



Central foot on request



The **lid** allow the containers with four feet and 1 pair of **connection pieces** to be **stacked on top**



The **lids** allow the containers with four feet to be **stacked on top**

One pair of cross-braces Ord. No. F PZ 8351 01 01 Dim. 800x132x29 mm h

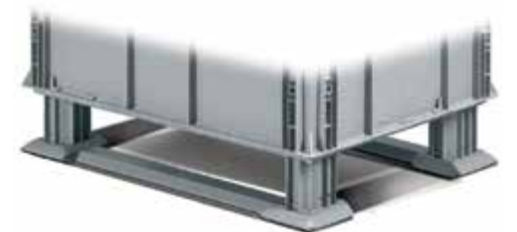



STACKING CONTAINERS SERIES RLKLT

The KLT Series is specifically designed for the automotive sector for moving parts between suppliers and automotive manufacturers.



good **resistance** to oils
different automated **handling** options
strong **ergonomics** handles
excellent level of **safety** and resistance
smooth bottom for noiseless movement on conveyors
perforated bottom for water **drainage**

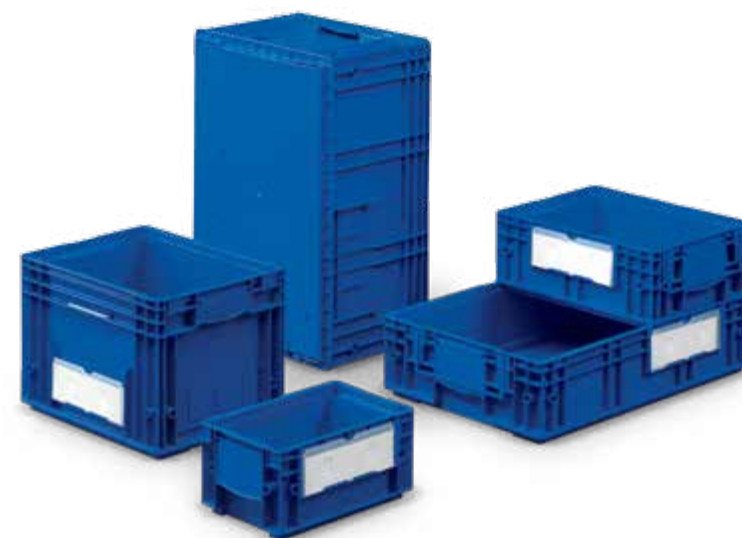

integrated lid slots on both sides

ergonomic grips



water drainage holes in the base

lower stacking recess

lifting slots for vertical retrieval

solid bottom

upper stacking edge

automatic centering hole

label holder

stable impact surfaces on the front and the sides allow the use in mini-load system

ergonomica handgrips

grooves for front handling



RL KLT 300x200

Manufactured in **polypropylene**, the **RL KLT 300x200** mm containers are the **optimal solution** for **storing small parts**.



| container ORD. NO. | A | B | B1 | C | D | E | F | G | H | H1 | I | L |
|--------------------|-----|-----|-----|-----|-----|-----|-----|-----|-----|-----|-----|-----|
| F PC 2351 00 27 | 297 | 250 | 272 | 243 | 267 | 129 | 147 | 197 | 168 | 172 | 161 | 168 |

The technical data contained in the above table is approximate. FAMI S.r.l. reserves the right to make any modifications it sees fit to improve the performance and appearance of products. The manufacturer is not liable for any printing errors.

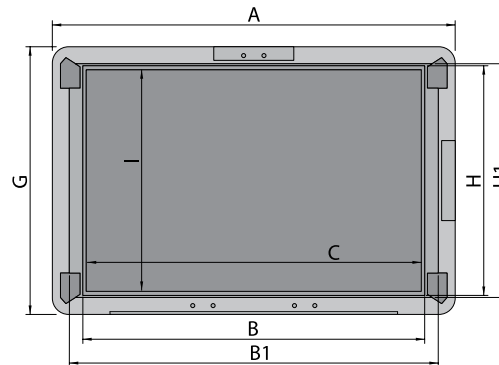
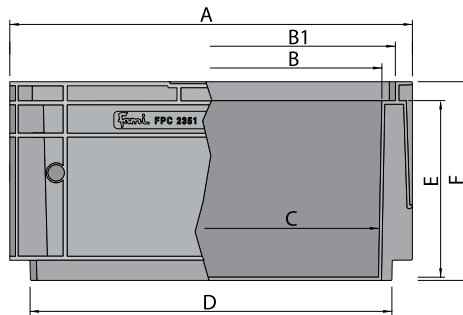
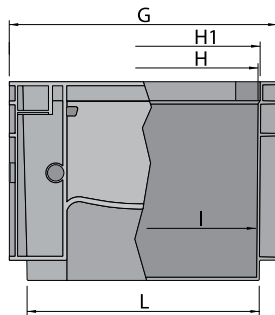

Detail of
**SOLID
BOTTOM**





SOLID BOTTOM



INTERNATIONAL CODE: RL-KLT 3147

ORD. NO. F PC 2351 00 27 -single

Measurements: KLT-3147

Standard colour: 27 blue ■

Weight gr.: 570

External nominal dim. mm: 300×200×147 h

Internal nominal dim. mm: 243×161×129 h

ORD. NO. FYC 2351 00 27 -pallet

Weight of pallet kg: 146

Qty. Containers per pallet: 240 pcs.

Shipping dimensions mm: 1200×800×2150 h

RL KLT 400x300

Manufactured in **Polypropylene**, the **RL KLT 400x300 mm** container is available in **two different heights** and can be closed with a handled cover.



| container ORD. NO. | A | B | B1 | C | D | E | F | G | H | H1 | I | L |
|--------------------|-----|-----|-----|-----|-----|-----|-----|-----|-----|-----|-----|-----|
| F PC 4251 00 27 | 396 | 348 | 370 | 346 | 365 | 130 | 147 | 297 | 266 | 270 | 262 | 266 |
| F PC 5051 00 27 | 396 | 348 | 370 | 345 | 366 | 260 | 280 | 296 | 266 | 269 | 262 | 266 |

The technical data contained in the above table is approximate. FAMI S.r.l. reserves the right to make any modifications it sees fit to improve the performance and appearance of products. The manufacturer is not liable for any printing errors.

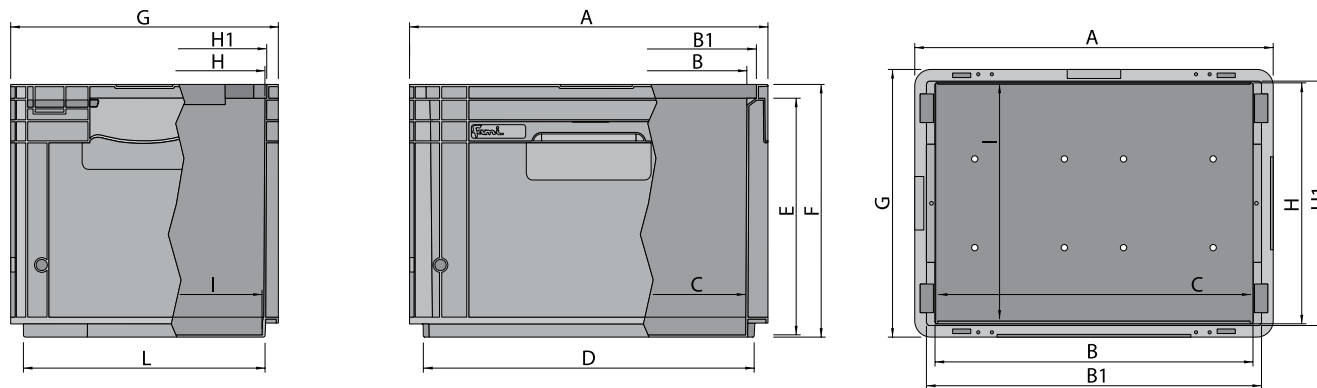

Detail of
**SOLID
BOTTOM**





SOLID BOTTOM



INTERNATIONAL CODE: RL-KLT 4147

ORD. NO. F PC 4251 00 27 -single

Measurements: KLT-4147

Standard colour: 27 blue ■

Weight gr.: 1080

External nominal dim. mm: 400x300x147 h

Internal nominal dim. mm: 346x262x130 h

ORD. NO. FYC 4251 00 27 -pallet

Weight of pallet kg: 147

Qty. Containers per pallet: 128 pcs.

Shipping dimensions mm: 1200x800x2250 h



SOLID BOTTOM



INTERNATIONAL CODE: RL-KLT 4280

ORD. NO. F PC 5051 00 27 -single

Measurements: KLT-4280

Standard colour: 27 blue ■

Weight gr.: 1700

External nominal dim. mm: 400x300x280 h

Internal nominal dim. mm: 345x262x260 h

ORD. NO. FYC 5051 00 27 -pallet

Weight of pallet kg: 118

Qty. Containers per pallet: 64 pcs.

Shipping dimensions mm: 1200x800x2250 h

RL KLT 600x400

Manufactured in **Polypropylene**, the **RL KLT 600x400** mm container is available in **two** different **heights** and can be closed with a handled cover.



| container ORD. NO. | A | B | B1 | C | D | E | F | G | H | H1 | I | L |
|--------------------|-----|-----|-----|-----|-----|-----|-----|-----|-----|-----|-----|-----|
| F PC 6651 00 27 | 593 | 544 | 567 | 543 | 561 | 129 | 147 | 395 | 363 | 369 | 358 | 364 |
| F PC 7251 00 27 | 594 | 545 | 567 | 543 | 562 | 260 | 280 | 396 | 364 | 369 | 357 | 364 |

The technical data contained in the above table is approximate. FAMI S.r.l. reserves the right to make any modifications it sees fit to improve the performance and appearance of products. The manufacturer is not liable for any printing errors.

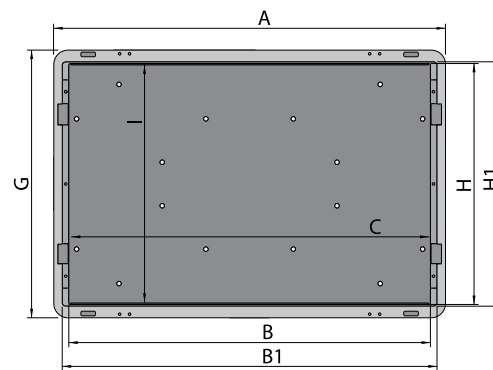
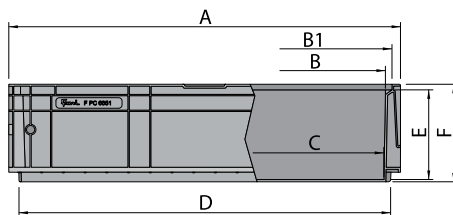
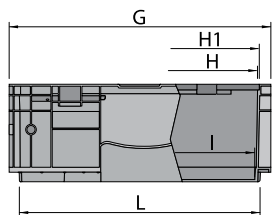

Detail of
SOLID
BOTTOM





SOLID BOTTOM



INTERNATIONAL CODE: RL-KLT 6147

ORD. NO. F PC 6651 00 27 -single

Measurements: KLT-6147

Standard colour: 27 blue ■

Weight gr.: 1820

External nominal dim. mm: 600×400×147 h

Internal nominal dim. mm: 543×358×129 h

ORD. NO. FYC 6651 00 27 -pallet

Weight of pallet kg: 118

Qty. Containers per pallet: 60 pcs.

Shipping dimensions mm: 1200×800×2150 h



SOLID BOTTOM



INTERNATIONAL CODE: RL-KLT 6280

ORD. NO. F PC 7251 00 27 -single

Measurements: KLT-6280

Standard colour: 27 blue ■

Weight gr.: 2670

External nominal dim. mm: 600×400×280 h

Internal nominal dim. mm: 543×357×260 h

ORD. NO. FYC 7251 00 27 -pallet

Weight of pallet kg: 94

Qty. Containers per pallet: 32 pcs.

Shipping dimensions mm: 1200×800×2250 h

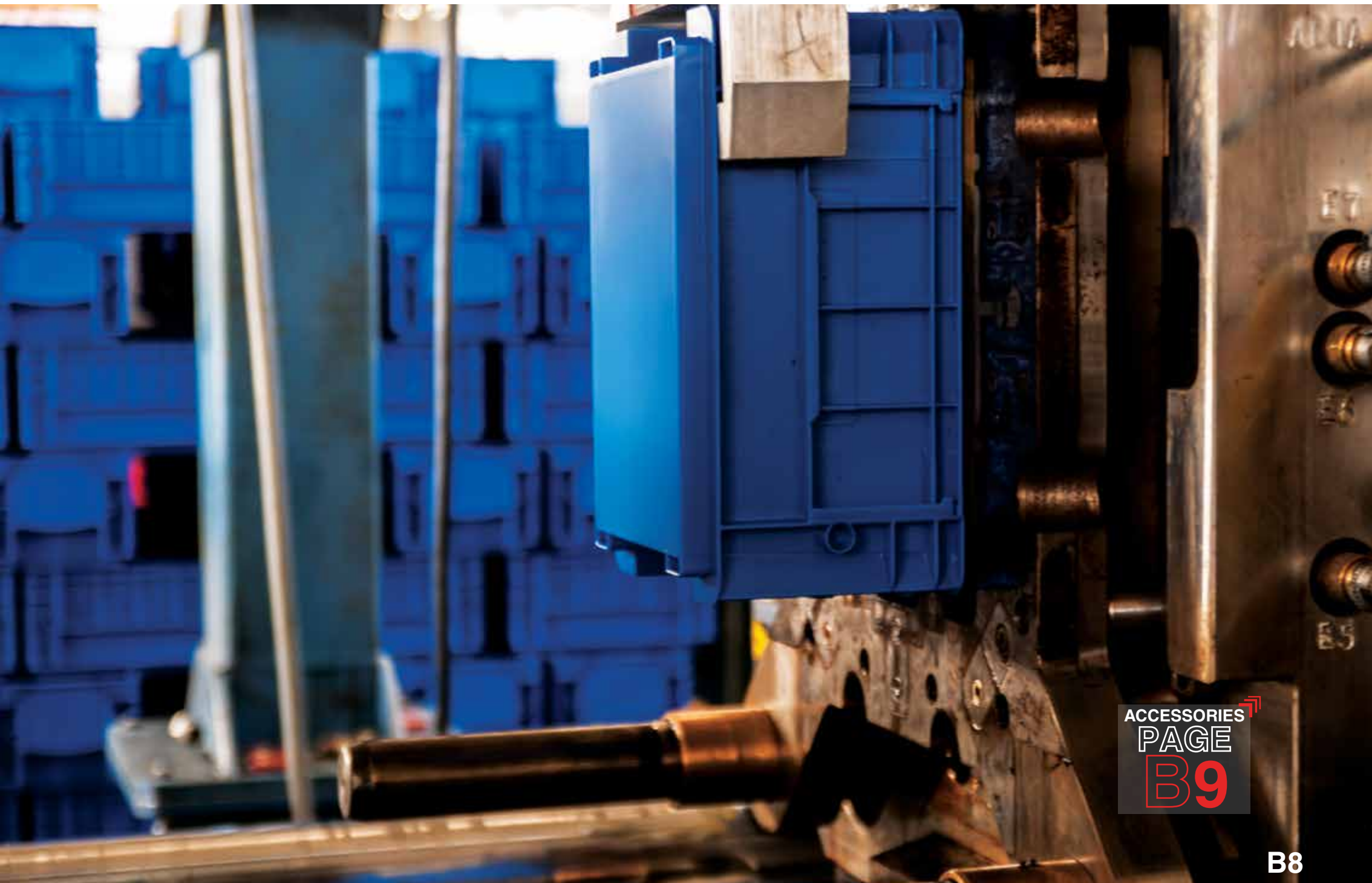

ACCESSORIES
PAGE
B9

ACCESSORIES
RLKIT

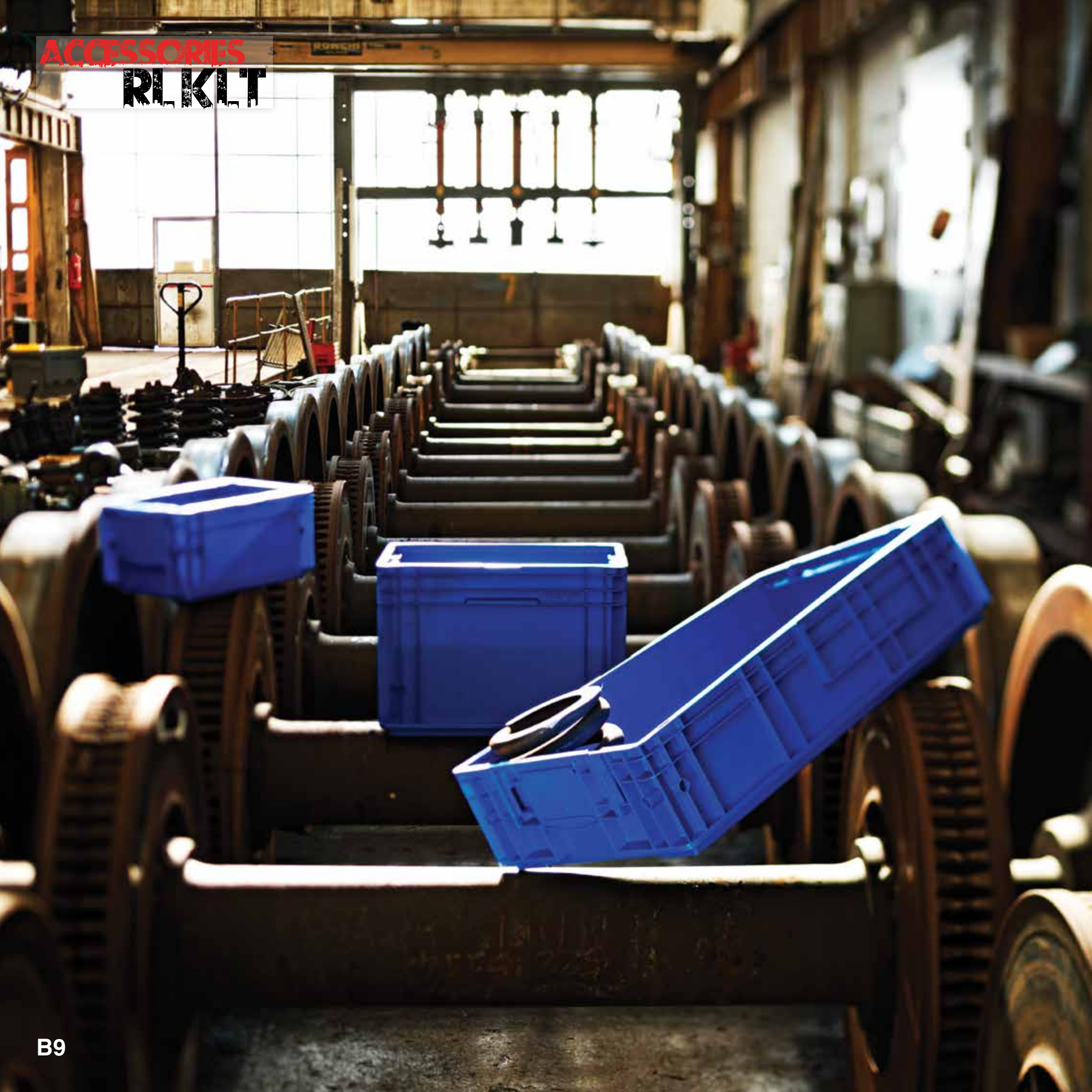

LIDS



LID WITH HANDLES



For boxes **ORD. NO.**
F PC 4251 00 27
F PC 5051 00 27



LID WITH HANDLES



For boxes **ORD. NO.**
F PC 6651 00 27
F PC 7251 00 27



| ORD. NO. | Lid with handles mm |
|-----------------|---------------------|
| F PA 1B51 00 27 | 400x300 |
| Weight gr. | 322 |

| ORD. NO. | Lid with handles mm |
|-----------------|---------------------|
| F PA 1C51 00 27 | 600x400 |
| Weight gr. | 720 |

27 BLUE

LABEL HOLDER
SEMI TRANSPARENT

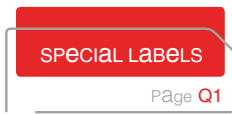

| ORD. NO. | DIM. mm |
|-----------------|---------|
| F PZ 9151 00 00 | 210x74 |

LABEL SHEET

| ORD. NO. | Label Dim. mm |
|----------------------------------------------|---------------|
| F A4 A513 04 00 | 150x67 |
| package of 25 pieces - quantity per sheet: 4 | |

OO COLOURS



B10

STACKING CONTAINERS SERIES

RKLT

The KLT Series is specifically designed for the automotive sector for moving parts between suppliers and automotive manufacturers.

B11



good **resistance** to oils
different automated **handling** options
strong **ergonomics** handles
excellent level of **safety** and resistance
reinforced bottom for **heavy** loads

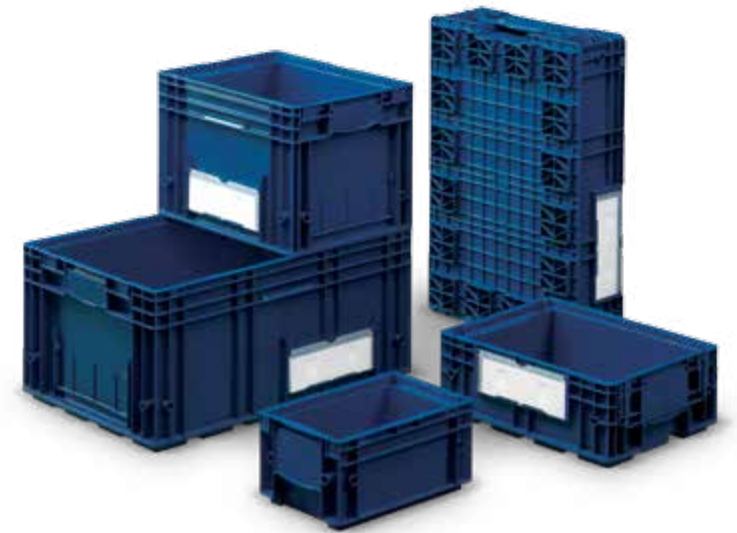

integrated lid slots on both sides

interlocking

ergonomic grips

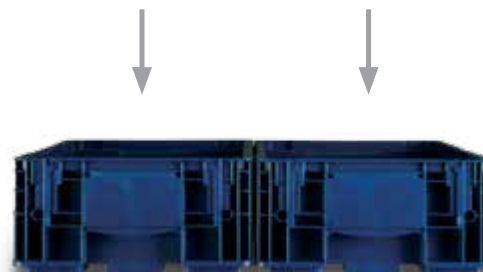

lifting slots for vertical retrieval

lower stacking recess

upper stacking edge

reinforced bottom

label holder

automatic centering hole

ergonomica handgrips

stable impact surfaces on the front and the sides allow the use in mini-load system

grooves for front handling



RKLT 300x200

Manufactured in **polypropylene**, the **R KLT 300x200** mm containers are the **optimal solution** for **storing small parts**.



| container ORD. NO. | A | B | B1 | C | D | E | F | G | H | H1 | I | L |
|--------------------|-----|-----|-----|-----|-----|-----|-----|-----|-----|-----|-----|-----|
| F PC 2351 00 IG | 297 | 250 | 272 | 243 | 267 | 129 | 147 | 197 | 168 | 172 | 161 | 168 |

The technical data contained in the above table is approximate. FAMI S.r.l. reserves the right to make any modifications it sees fit to improve the performance and appearance of products. The manufacturer is not liable for any printing errors.

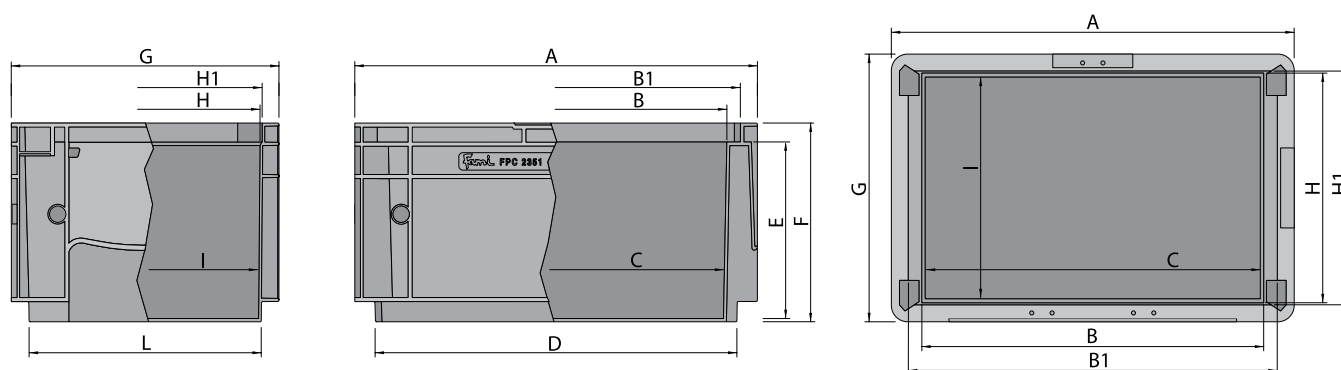

Detail of
SOLID
BOTTOM



INTERNATIONAL CODE: R-KLT 3215

ORD. NO. F PC 2351 00 IG **-single**

Measurements: KLT-3215

Standard colour: IG blue ■

Weight gr.: 570

External nominal dim. mm: 300×200×147 h

Internal nominal dim. mm: 243×161×129 h

ORD. NO. FYC 2351 00 IG **-pallet**

Weight of pallet kg: 146

Qty. Containers per pallet: 240 pcs.

Shipping dimensions mm: 1200×800×2150 h



SOLID BOTTOM



ACCESSORIES
PAGE
B19

RKLT 400x300

Manufactured in **Polypropylene**, the **R KLT 400x300** mm container is available in **two** different **heights** and can be closed with a handled cover.



| container ORD. NO. | A | B | B1 | C | D | E | F | G | H | H1 | I | L |
|--------------------|-----|-----|-----|-----|-----|-----|-----|-----|-----|-----|-----|-----|
| F PC 4351 00 IG | 396 | 347 | 370 | 345 | 365 | 111 | 147 | 295 | 267 | 271 | 264 | 267 |
| F PC 5151 00 IG | 396 | 348 | 370 | 345 | 365 | 241 | 280 | 295 | 265 | 270 | 263 | 266 |

The technical data contained in the above table is approximate. FAMI S.r.l. reserves the right to make any modifications it sees fit to improve the performance and appearance of products. The manufacturer is not liable for any printing errors.

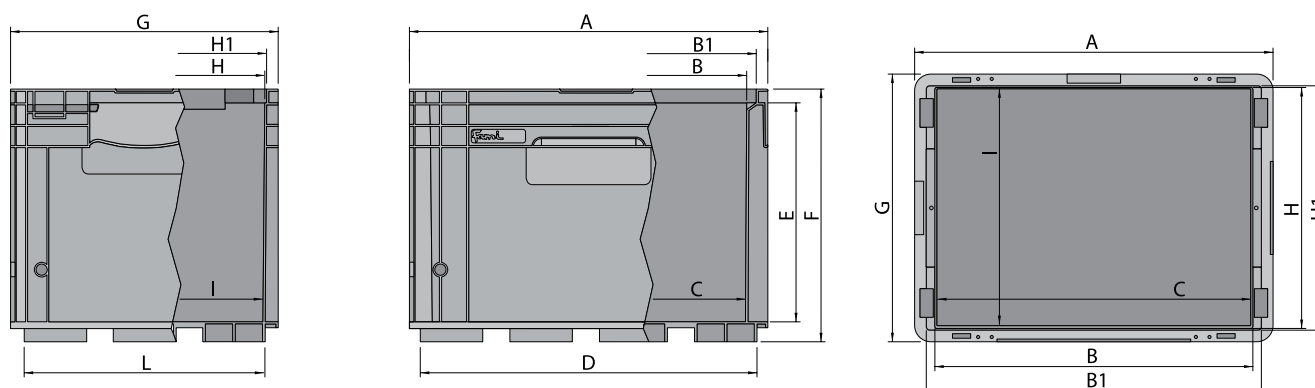

Detail of
**REINFORCED
BOTTOM**





REINFORCED BOTTOM



INTERNATIONAL CODE: R-KLT 4315

ORD. NO. F PC 4351 00 IG -single

Measurements: KLT-4315 FR

Standard colour: IG blue ■

Weight gr.: 1290

External nominal dim. mm: 400×300×147 h

Internal nominal dim. mm: 345×264×111 h

ORD. NO. F YC 4351 00 IG -pallet

Weight of pallet kg: 174

Qty. Containers per pallet: 128 pcs.

Shipping dimensions mm: 1200×800×2250 h



REINFORCED BOTTOM



INTERNATIONAL CODE: R-KLT 4329

ORD. NO. F PC 5151 00 IG -single

Measurements: KLT-4329 FR

Standard colour: IG blue ■

Weight gr.: 1850

External nominal dim. mm: 400×300×280 h

Internal nominal dim. mm: 345×263×241 h

ORD. NO. F YC 5151 00 IG -pallet

Weight of pallet kg: 127

Qty. Containers per pallet: 64 pcs.

Shipping dimensions mm: 1200×800×2250 h



ACCESSORIES
PAGE
B19

RKLT 600x400

Manufactured in **Polypropylene**, the **R KLT 600x400** mm container is available in **two** different heights and can be closed with a handled cover.



| container ORD. NO. | A | B | B1 | C | D | E | F | G | H | H1 | I | L |
|--------------------|-----|-----|-----|-----|-----|-----|-----|-----|-----|-----|-----|-----|
| F PC 6751 00 IG | 593 | 544 | 567 | 543 | 561 | 111 | 147 | 395 | 363 | 369 | 363 | 364 |
| F PC 7351 00 IG | 593 | 546 | 568 | 543 | 563 | 242 | 280 | 395 | 365 | 370 | 363 | 365 |

The technical data contained in the above table is approximate. FAMI S.r.l. reserves the right to make any modifications it sees fit to improve the performance and appearance of products. The manufacturer is not liable for any printing errors.

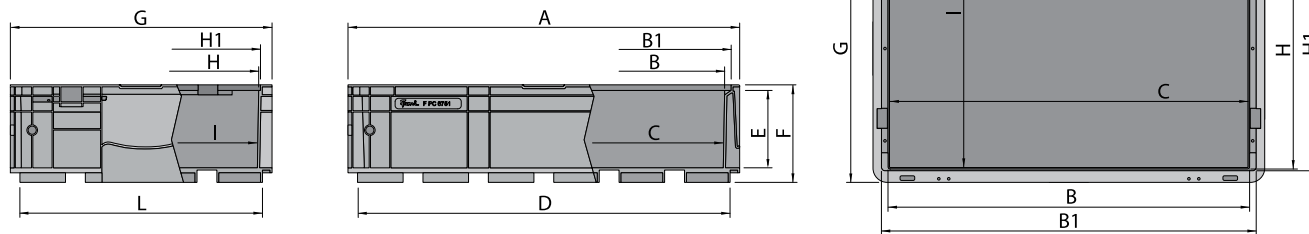

Detail of
**REINFORCED
BOTTOM**

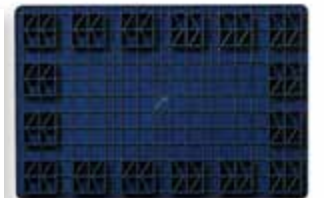



REINFORCED BOTTOM



INTERNATIONAL CODE: R-KLT 6415

ORD. NO. F PC 6751 00 IG -single

Measurements: KLT-6415 FR

Standard colour: IG blue ■

Weight gr.: 2100

External nominal dim. mm: 600×400×147 h

Internal nominal dim. mm: 543×363×111 h

ORD. NO. FYC 6751 00 IG -pallet

Weight of pallet kg: 135

Qty. Containers per pallet: 60 pcs.

Shipping dimensions mm: 1200×800×2150 h



REINFORCED BOTTOM



INTERNATIONAL CODE: R-KLT 6429

ORD. NO. F PC 7351 00 IG -single

Measurements: KLT-6429 FR

Standard colour: IG blue ■

Weight gr.: 2970

External nominal dim. mm: 600×400×280 h

Internal nominal dim. mm: 543×363×242 h

ORD. NO. FYC 7351 00 IG -pallet

Weight of pallet kg: 104

Qty. Containers per pallet: 32 pcs.

Shipping dimensions mm: 1200×800×2250 h

ACCESSORIES
PAGE
B19



ACCESSORIES
RKLT



LIDS



LID WITH HANDLES



For boxes **ORD. NO.**
F PC 4351 00 IG
F PC 5151 00 IG



LID WITH HANDLES



For boxes **ORD. NO.**
F PC 6751 00 IG
F PC 7351 00 IG



| ORD. NO. | Lid with handles mm |
|------------------------|---------------------|
| F PA 1B51 00 IG | 400x300 |
| Weight gr. | 322 |

| ORD. NO. | Lid with handles mm |
|------------------------|---------------------|
| F PA 1C51 00 IG | 600x400 |
| Weight gr. | 720 |

BLUE IG

LABEL HOLDER
SEMI TRANSPARENT

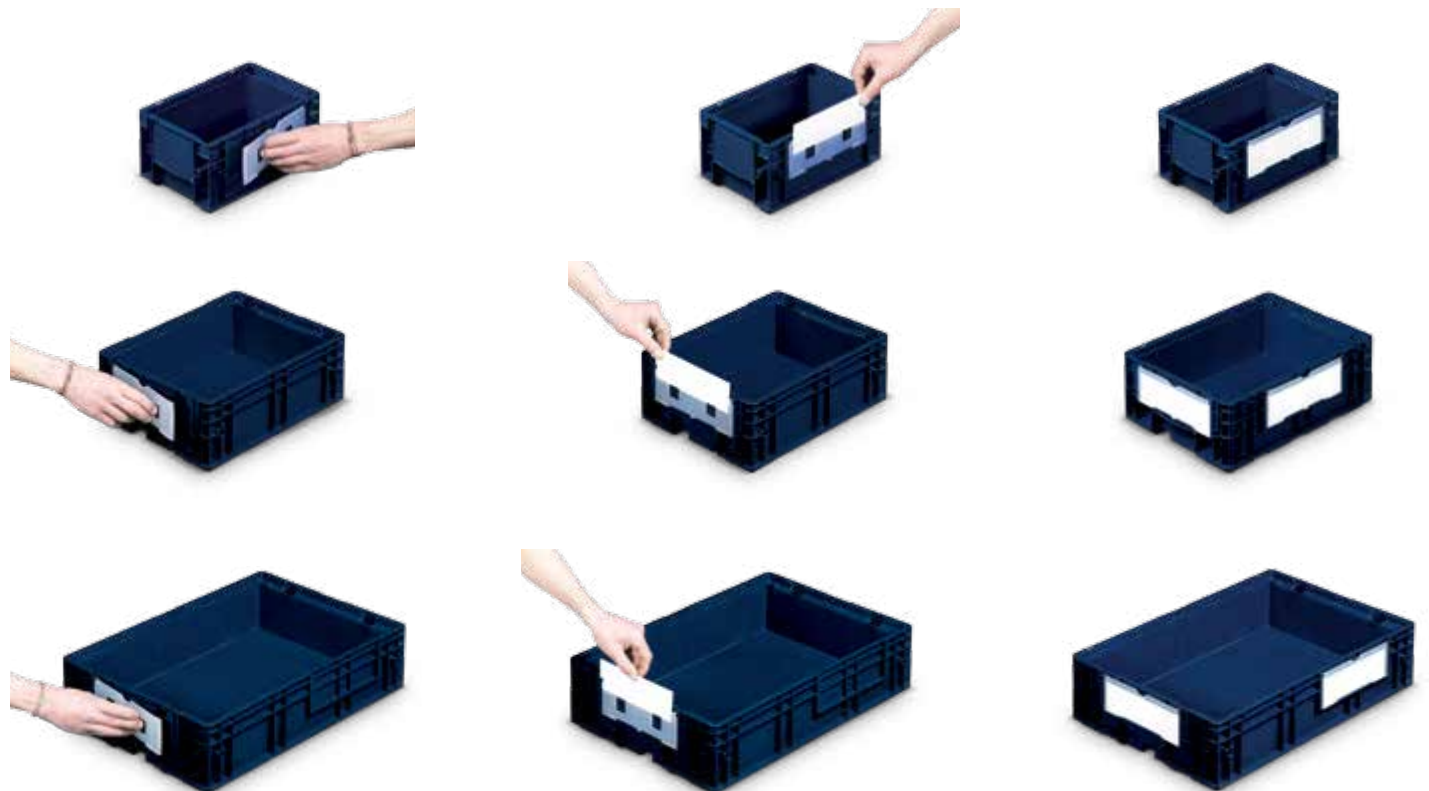
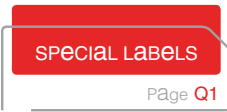

| ORD. NO. | DIM. mm |
|------------------------|---------|
| F PZ 9151 00 00 | 210x74 |

LABEL SHEET

| ORD. NO. | Label Dim. mm |
|----------------------------------------------|---------------|
| F A4 A513 04 00 | 150x67 |
| package of 25 pieces - quantity per sheet: 4 | |

OO COLOURS



B20

STACKING CONTAINERS SERIES

ODETTE

FAMI is the **only** Italian company to produce containers **approved** by the “Odette” European commission. They have the following **features**:

- **8** different **automatic handling** systems;
- tough **ergonomic handles**;
- good ratio between **external** volume and **useful** volume;
- **reinforced** and structured bottom for **easy** sliding along all kinds of **roller conveyors**;
- can be **palletised** and **stacked** even with **different sizes** of containers;
- **2** label holders for **A5 “bar code”** labels in “Odette” standard;
- high level of **safety** (coefficient **3** measured in the various **crash tests**).

The **Odette** series of containers, available in **yellow**, were designed and produced as part of the “**Odette**” project (Organisation Data Exchange by Tele Transmission in Europe), adhered to by a considerable number of **important** Italian and international **companies**, especially in the automotive sector. The “**Odette**” stacking containers were produced as a result of the close **collaboration** with **European companies in the automotive sector**. The “**Odette**” project began in **1985** at **European** level with the aim of **creating harmonised** standards for containers that handle and transport small volumes or limited quantities of materials.

handling from top

handling from bottom

handling from side

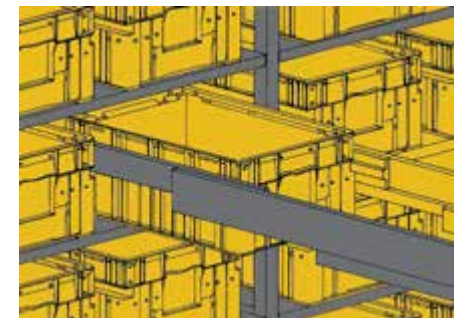
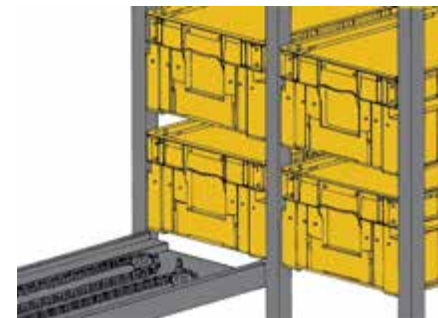
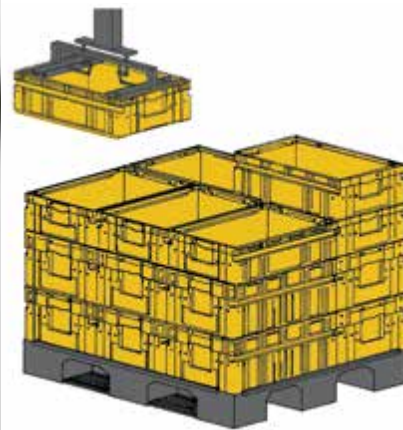

base grooving suitable for all roller conveyors

holes for vertical handling

cover fastener

handle on side

lower stacking recess



upper stacking edge

guides on side for horizontal handling

grooves for vertical handling

label holder

grooves for front handling

ODETTE 300x200

Produced in **Polypropylene**, the **Odette** series containers **300x200 mm** are an **ideal solution** for **stocking small parts**. Available in **one height** and can be closed with a cover.



05 YELLOW

| container ORD. NO. | A | B | C | D | E | F | G | H | I | L |
|--------------------|-----|-----|-----|-----|-----|-----|-----|-----|-----|-----|
| F PC 2451 00 05 | 296 | 270 | 235 | 266 | 126 | 147 | 198 | 172 | 161 | 168 |

The technical data contained in the above table is approximate. FAMI S.r.l. reserves the right to make any modifications it sees fit to improve the performance and appearance of products. The manufacturer is not liable for any printing errors.

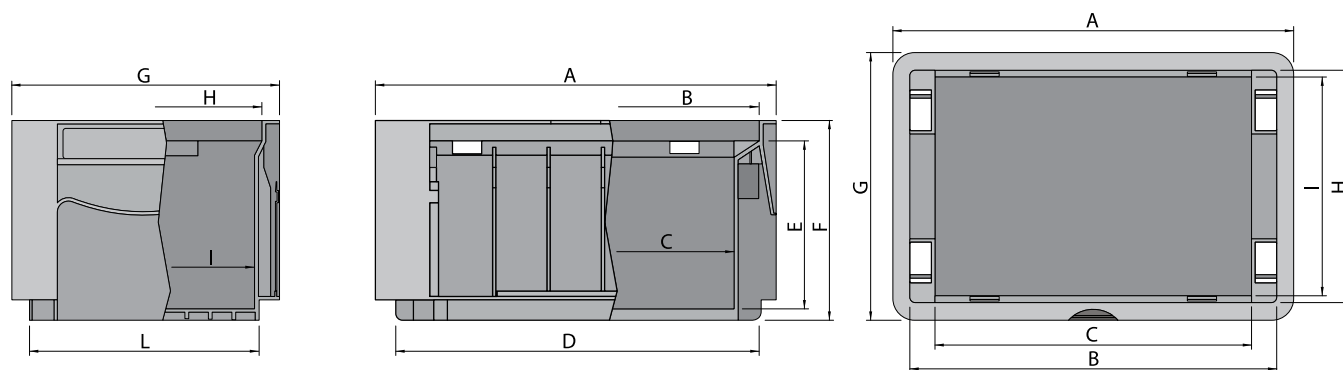

Detail of
**REINFORCED
BOTTOM**

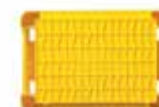



REINFORCED BOTTOM



ORD. NO. F PC 2451 00 05 -single

Measurements: 4950 FR

Standard colour: 05 yellow 

Weight gr.: 600

External nominal dim. mm: 300x200x147 h

Internal nominal dim. mm: 235x161x126 h

ORD. NO. FYC 2451 00 05 -pallet

Weight of pallet kg: 153

Qty. Containers per pallet: 240 pcs.

Shipping dimensions mm: 1200x800x2150 h

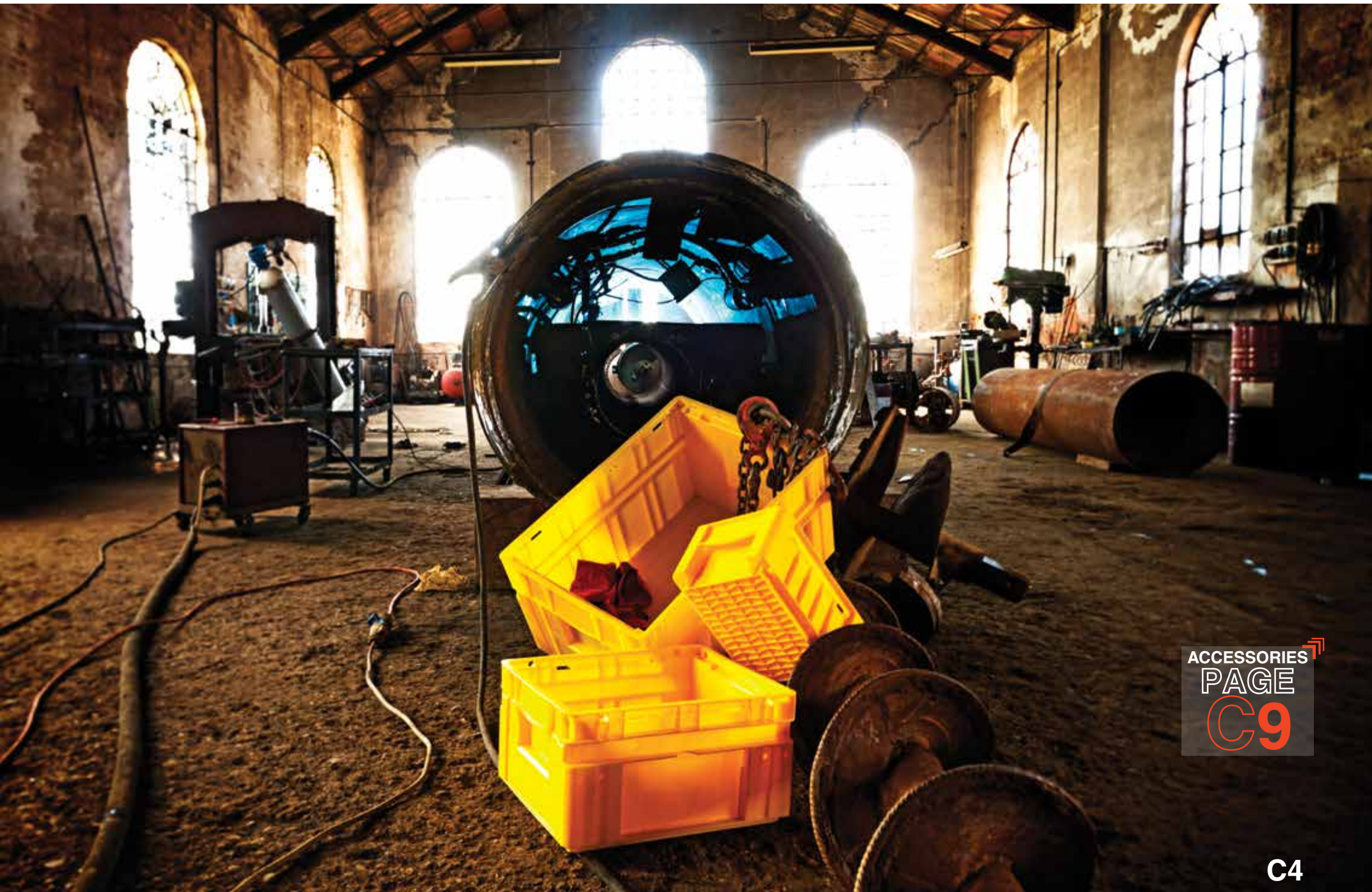

ODETTE 400x300

Produced in **Polypropylene**, the **Odette** series containers **400x300** mm are available in **one height** and can be closed with a **cover**.



05 YELLOW

| container ORD. NO. | A | B | C | D | E | F | G | H | I | L |
|--------------------|-----|-----|-----|-----|-----|-----|-----|-----|-----|-----|
| F PC 4851 00 05 | 398 | 371 | 336 | 366 | 186 | 214 | 297 | 272 | 261 | 265 |

The technical data contained in the above table is approximate. FAMI S.r.l. reserves the right to make any modifications it sees fit to improve the performance and appearance of products. The manufacturer is not liable for any printing errors.

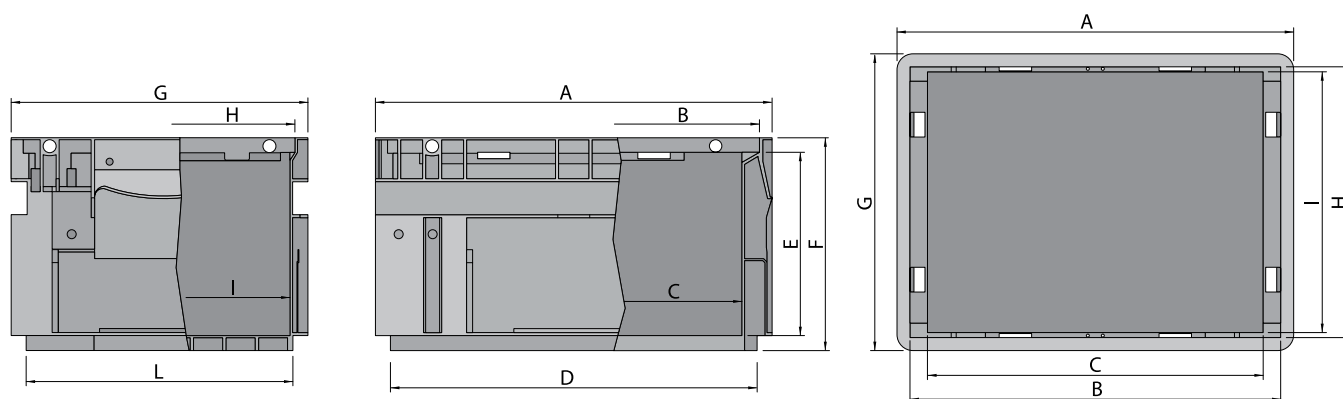

Detail of
**REINFORCED
BOTTOM**



C5

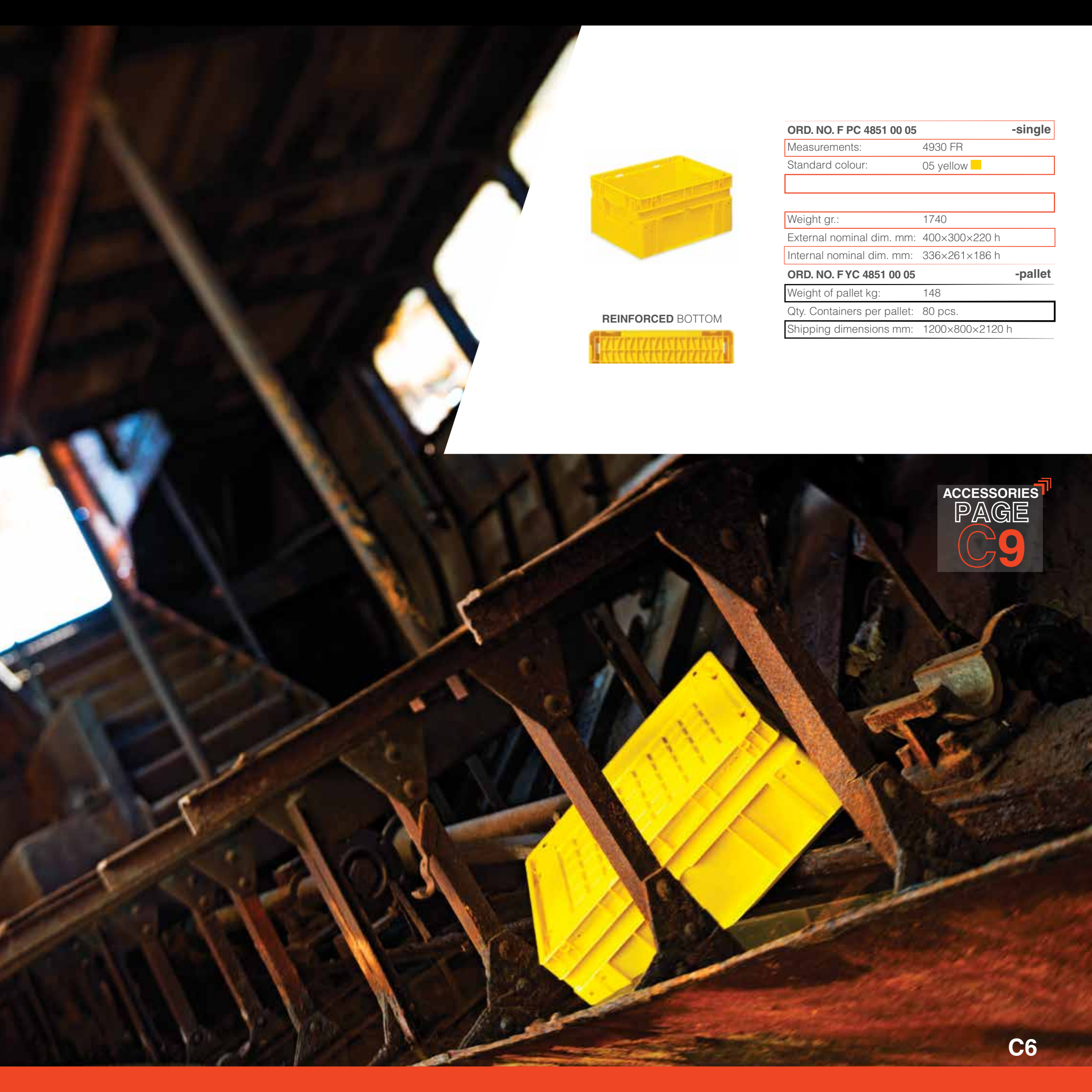

REINFORCED BOTTOM



ORD. NO. F PC 4851 00 05 **-single**

Measurements: 4930 FR

Standard colour: 05 yellow 

Weight gr.: 1740

External nominal dim. mm: 400x300x220 h

Internal nominal dim. mm: 336x261x186 h

ORD. NO. FYC 4851 00 05 **-pallet**

Weight of pallet kg: 148

Qty. Containers per pallet: 80 pcs.

Shipping dimensions mm: 1200x800x2120 h

ACCESSORIES
PAGE
C9

ODETTE 600x400

Produced in **Polypropylene**, the **Odette** series containers **600x400** mm are an **ideal solution** for **stocking** large parts. The containers are available in **various heights** and can be closed with a cover.



PERSONALISED

LOGOS

PAGE R1

05 YELLOW

| container ORD. NO. | A | B | C | D | E | F | G | H | I | L |
|--------------------|-----|-----|-----|-----|-----|-----|-----|-----|-----|-----|
| F PC 6851 00 05 | 596 | 570 | 535 | 564 | 184 | 215 | 397 | 371 | 361 | 364 |
| F PC 7651 00 05 | 595 | 570 | 535 | 563 | 282 | 315 | 397 | 371 | 361 | 364 |

The technical data contained in the above table is approximate. FAMI S.r.l. reserves the right to make any modifications it sees fit to improve the performance and appearance of products. The manufacturer is not liable for any printing errors.

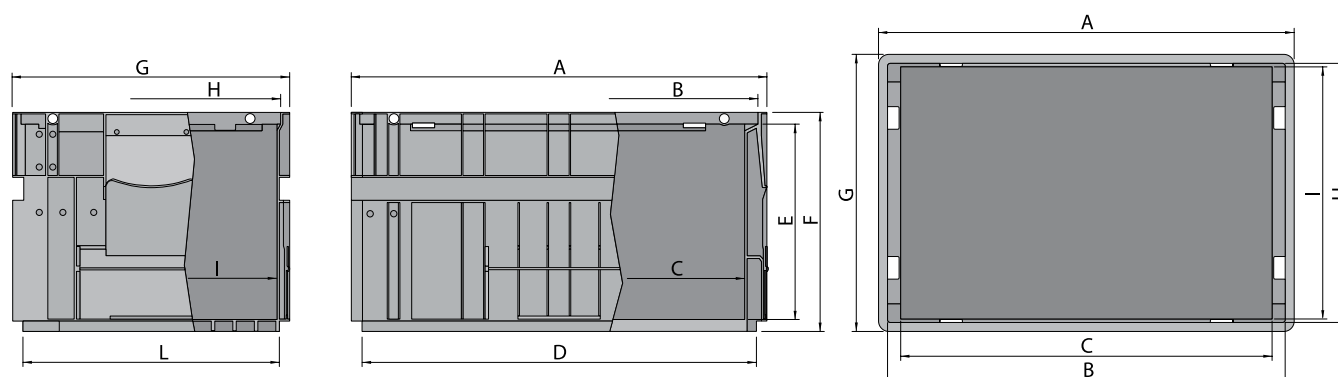

Detail of
**REINFORCED
BOTTOM**



ACCESSORIES
PAGE
C9

C7



REINFORCED BOTTOM



ORD. NO. F PC 6851 00 05 -single

Measurements: 4910 FR
Standard colour: 05 yellow ■

Weight gr.: 2820
External nominal dim. mm: 600×400×220 h
Internal nominal dim. mm: 535×361×184 h

ORD. NO. FYC 6851 00 05 -pallet

Weight of pallet kg: 122
Qty. Containers per pallet: 40 pcs.
Shipping dimensions mm: 1200×800×2150 h



REINFORCED BOTTOM



ORD. NO. F PC 7651 00 05 -single

Measurements: 4900 FR
Standard colour: 05 yellow ■

Weight gr.: 4020
External nominal dim. mm: 600×400×320 h
Internal nominal dim. mm: 535×361×282 h

ORD. NO. FYC 7651 00 05 -pallet

Weight of pallet kg: 122
Qty. Containers per pallet: 28 pcs.
Shipping dimensions mm: 1200×800×2250 h

ODETTE 1000×400



ORD. NO. F PC 9651 00 05 -single

Measurements: 4960 FR
Standard colour: 05 yellow ■

Weight gr.: 3370
External nominal dim. mm: 1000×400×232 h
Internal nominal dim. mm: 934×353×201 h

ORD. NO. FYC 9651 00 05 -pallet

Weight of pallet kg: 110
Qty. Containers per pallet: 30 pcs.
Shipping dimensions mm: 1200×1000×2300 h

REINFORCED BOTTOM

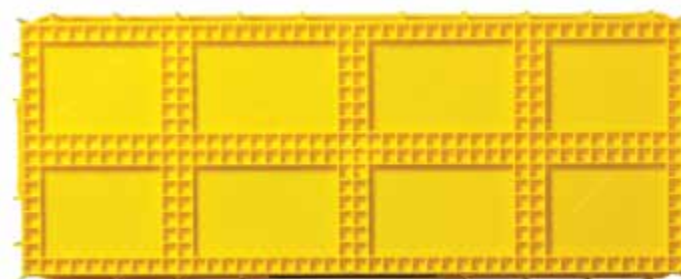

Detail of stacking containers with **reinforced bottom** ORD. NO. F PC 9651 00 05

technical specifications odette 1000×400

| container ORD. NO. | A | B | C | D | E | F | G | H | I | L | M |
|--------------------|-----|-----|-----|-----|-----|-----|-----|-----|-----|-----|------|
| F PC 9651 00 05 | 978 | 935 | 934 | 933 | 201 | 232 | 400 | 354 | 353 | 354 | 1004 |

The technical data contained in the above table is approximate. FAMI S.r.l. reserves the right to make any modifications it sees fit to improve the performance and appearance of products. The manufacturer is not liable for any printing errors.

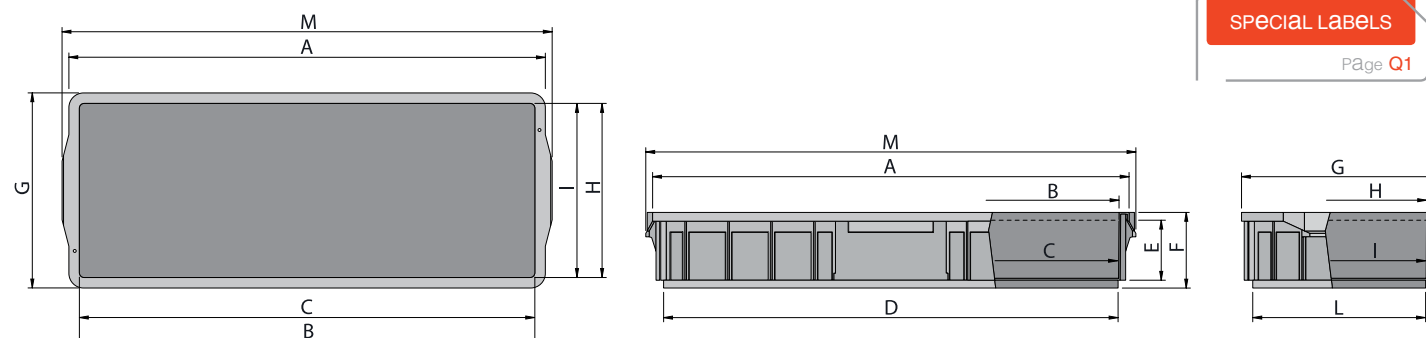

Label holder frame:
F A9 A414 MI 96
F A9 A413 MI 96
F A9 A500 MI 96

only for stacking container ord. no. F PC 9651 00 05

ACCESSOIRES
ODETTE



LIDS



300x200



400x300



600x400



cover

F PC 0951 00 05
on container ORD.
NO. F PC 6851 00 05



| ORD. NO. | Lid mm |
|-----------------|---------|
| F PC 0351 00 05 | 300x200 |
| Weight gr. | 110 |

| ORD. NO. | Lid mm |
|-----------------|---------|
| F PC 0651 00 05 | 400x300 |
| Weight gr. | 240 |

| ORD. NO. | Lid mm |
|-----------------|---------|
| F PC 0951 00 05 | 600x400 |
| Weight gr. | 500 |

05 YELLOW



 000010521
Materiale: SMT690655
Dsc: TUBO SAGOMATO Ø 12X1,0 ZINCATO
Qta: 170 Ubicazione:
Contenitore:
Descr. Cont.:
Lotto multiple: 000
Lead time: 20 Cliente:
Data: 05.02.2013 -- 05.03.2013

C10

STACKING CONTAINERS SERIES
THEMA



D1

Made from **top quality polypropylene**, the **Thema** series of stacking containers has been designed and produced to cater for the **new techniques** of storage and transport of all kinds of material. Featuring **sturdy ribbing** to stand up to the **heaviest loads**, they are available in **standard grey** and can also be used in the **food industry**. They are available in the **solid** or **perforated** versions, with **lifting bars** or **holes**. The perforated version allows an **immediate check** of the **quantity** and **type** of material stored to be made and also allows the material to be aired if required.

lifting



LifTiNG hole



LifTiNG bar



walls

SOLiD side walls



PERFORATED side walls



bottoms

solid bottom



perforated bottom

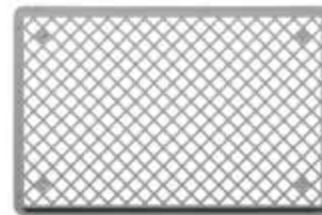

stacking container combinations

A0



- solid side walls -



- lifting bars -



- solid bottom -

B0



- solid side walls -



- lifting holes -



- solid bottom -

F0



- perforated side walls -



- lifting holes -



- perforated bottom -



THEMA 600x400

Produced in **Polypropylene**, the **Thema** series **600x400** is available in **one height** and can be closed with a hinged cover or a cover with handle.



PERSONALISED
LOGOS
PAGE R1

| container ORD. NO. | A | B | C | D | E | F | G | H | I | L |
|--------------------|-----|-----|-----|-----|-----|-----|-----|-----|-----|-----|
| F PB 6851 A0 01 | 601 | 568 | 554 | 560 | 200 | 220 | 401 | 367 | 355 | 361 |
| F PB 6851 B0 01 | 601 | 569 | 555 | 560 | 200 | 220 | 400 | 368 | 354 | 360 |
| F PB 6851 F0 01 | 600 | 568 | 554 | 559 | 198 | 220 | 400 | 367 | 354 | 360 |

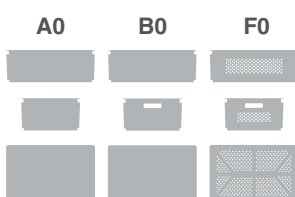

The technical data contained in the above table is approximate. FAMI S.r.l. reserves the right to make any modifications it sees fit to improve the performance and appearance of products. The manufacturer is not liable for any printing errors.

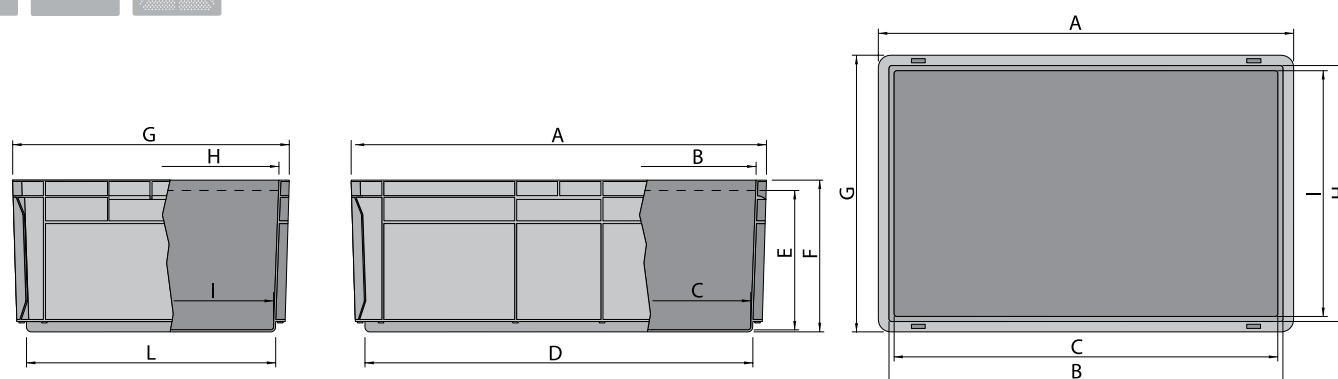

Detail of
SOLID
BOTTOM



Detail of
PERFORATED
BOTTOM

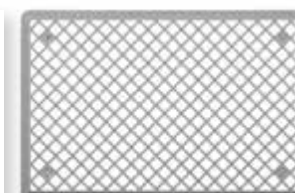



SOLID BOTTOM



SOLID BOTTOM



PERFORATED BOTTOM



ORD. NO. F PB 6851 A0 01 -single

Measurements: 6422-TA

Standard colour: 01 grey ■

Weight gr.: 1960

External nominal dim. mm: 600×400×220 h

Internal nominal dim. mm: 554×355×200 h

ORD. NO. FYB 6851 A0 01 -pallet

Weight of pallet kg: 87

Qty. Containers per pallet: 40 pcs.

Shipping dimensions mm: 1200×800×2200 h

ORD. NO. F PB 6851 B0 01 -single

Measurements: 6422-TB

Standard colour: 01 grey ■

Weight gr.: 1950

External nominal dim. mm: 600×400×220 h

Internal nominal dim. mm: 555×354×200 h

ORD. NO. FYB 6851 B0 01 -pallet

Weight of pallet kg: 87

Qty. Containers per pallet: 40 pcs.

Shipping dimensions mm: 1200×800×2200 h

ORD. NO. F PB 6851 F0 01 -single

Measurements: 6422-TF

Standard colour: 01 grey ■

Weight gr.: 1476

External nominal dim. mm: 600×400×220 h

Internal nominal dim. mm: 554×354×198 h

ORD. NO. FYB 6851 F0 01 -pallet

Weight of pallet kg: 68

Qty. Containers per pallet: 40 pcs.

Shipping dimensions mm: 1200×800×2200 h

ACCESSORIES
THEMA
600x400



LIDS



HINGED LID



LID WITH HANDLES



| | |
|------------------------|---------------|
| ORD. NO. | Hinged lid mm |
| F PA 0951 00 01 | 600x400 |
| Weight gr. | 700 |

| | |
|------------------------|---------------------|
| ORD. NO. | Lid with handles mm |
| F PA 1C51 00 01 | 600x400 |
| Weight gr. | 720 |

01 GREY

CLOSING SYSTEMS

The **covers** for the **Thema** series of stacking containers can be **closed** with **nylon kick-in locks**.



CLOSED AND SEALED

| | |
|------------------------|-------------------------------------------------------------|
| ORD. NO. | Pair of sliding hooks suitable for Thema series containers. |
| F PZ 0681 00 13 | |

13 WHITE

LABELS



| label sheet | for stacking container ORD. NO. | label dimension mm | number of labels per sheet |
|-----------------|-------------------------------------------------------|--------------------|-------------------------------|
| F PL 9140 00 00 | F PB 6851 A0 01 F PB 6851 B0 01 F PB 6851 F0 01 | 189x82 | 3 |

SPECIAL LABELS

Page **Q1**

The technical data contained in the above table is approximate. FAMI S.r.l. reserves the right to make any modifications it sees fit to improve the performance and appearance of products. The manufacturer is not liable for any printing errors.



D6

SLOTTED PARTITIONS



In order to **arrange** and **protect** particularly delicate material or material that must not come into contact with other products when being **moved** and **stored**, Fami has designed and produced a **system for dividing** the stacking containers by means of **slotted partitions**. Made from **plastic** and available in **various sizes**, they feature **partitions slotted** in increments of 20 mm. They **divide the insides of stacking containers** in a rational and varied way **according to user requirements**.

height mm 45 h

height mm 70 h

height mm 90 h

height mm 120 h

height mm 180 h

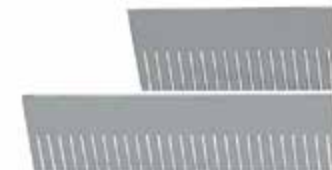
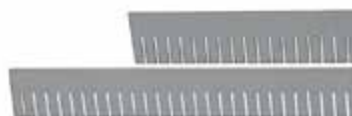

| ORD. NO. | DIM. mm | Increments mm |
|-----------------|---------|---------------|
| F HN 1420 00 01 | 355x45 | 20 |
| F HN 1620 00 01 | 555x45 | 20 |

| ORD. NO. | DIM. mm | Increments mm |
|-----------------|---------|---------------|
| F HN 1440 00 01 | 355x70 | 20 |
| F HN 1640 00 01 | 555x70 | 20 |

| ORD. NO. | DIM. mm | Increments mm |
|-----------------|---------|---------------|
| F HN 1450 00 01 | 355x90 | 20 |
| F HN 1650 00 01 | 555x90 | 20 |

| ORD. NO. | DIM. mm | Increments mm |
|-----------------|---------|---------------|
| F HN 1460 00 01 | 355x120 | 20 |
| F HN 1660 00 01 | 555x120 | 20 |

| ORD. NO. | DIM. mm | Increments mm |
|-----------------|---------|---------------|
| F HN 1470 00 01 | 355x180 | 20 |
| F HN 1670 00 01 | 555x180 | 20 |

COVER OR LAYER SEPARATOR

Made out of **plastic**, the **intermediate plate** acts as a **separator** if the container is **divided** into layers. The **lateral grooves** on the cover **make it easy to grip and lift**.

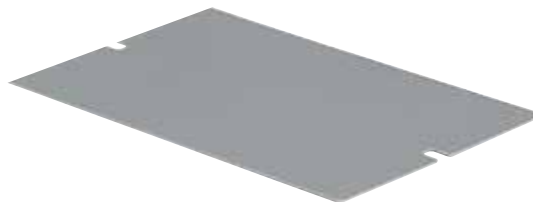

| ORD. NO. | DIM. mm |
|-----------------|---------|
| F HN 5140 00 01 | 555x355 |



01 GREY

METAL CLIPS

These metal clips can be **snapped** into the long or short sides of the **Thema** stacking containers and are used to **keep documents in place**.



SPECIAL LABELS

Page Q1



| ORD. NO. | DIM. mm |
|-----------------|----------|
| F PZ 0010 00 99 | 75x20x20 |

example of metal clip use

fitting the metal clip

99 HOT GALVANISED

D7

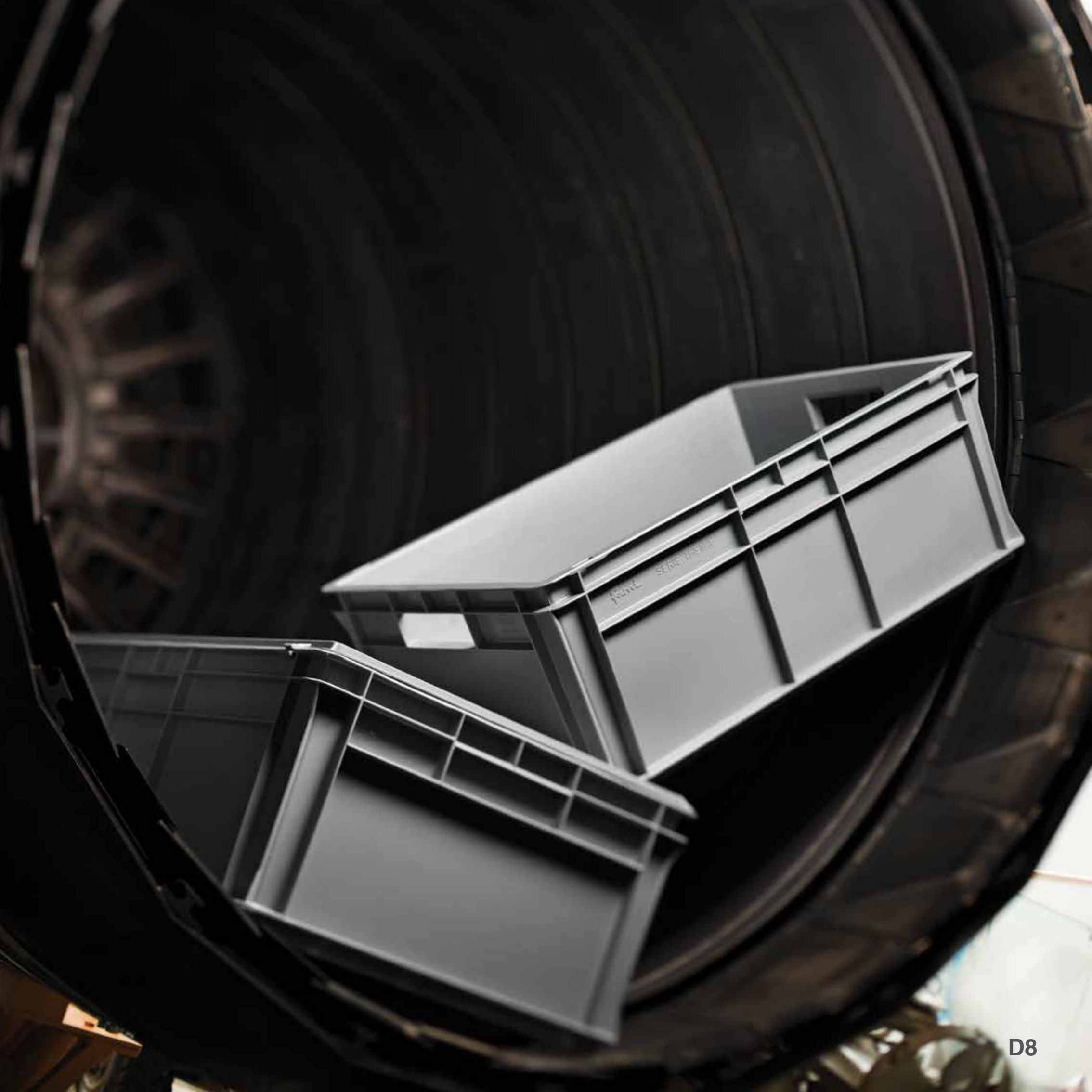

STACKING CONTAINERS SERIES
GOLD BOX
SECURITY SHELL



Security-Shell



Hinged lid with click closing
The lid can be fastened with a security seal

To open the lid push the central part



Lid with click closing can not be reutilized



Gold Box

The lid can be fastened with a security seal



Sliding lid with click closing



GOLD BOX

Produced in **Polypropylene**, the **Gold Box** series containers are the **ideal solution** for **stocking small parts**. They are available in **three** different **heights** and can be closed with a sliding cover.



OF GREY

| container ORD. NO. | A | B | C | D | E | F | G | H | I | L | A1 | G1 | F1 |
|--------------------|-----|-----|-----|-----|-----|-----|-----|-----|-----|-----|-----|-----|-----|
| F PH 3651 AC 01 | 227 | 201 | 188 | 182 | 92 | 105 | 181 | 144 | 136 | 130 | 234 | 184 | 106 |
| F PH 4851 AC 01 | 231 | 197 | 180 | 170 | 88 | 99 | 335 | 302 | 285 | 269 | 237 | 338 | 99 |
| F PH 5251 AC 01 | 229 | 196 | 176 | 169 | 143 | 153 | 334 | 302 | 282 | 269 | 238 | 338 | 153 |

The technical data contained in the above table is approximate. FAMI S.r.l. reserves the right to make any modifications it sees fit to improve the performance and appearance of products. The manufacturer is not liable for any printing errors.

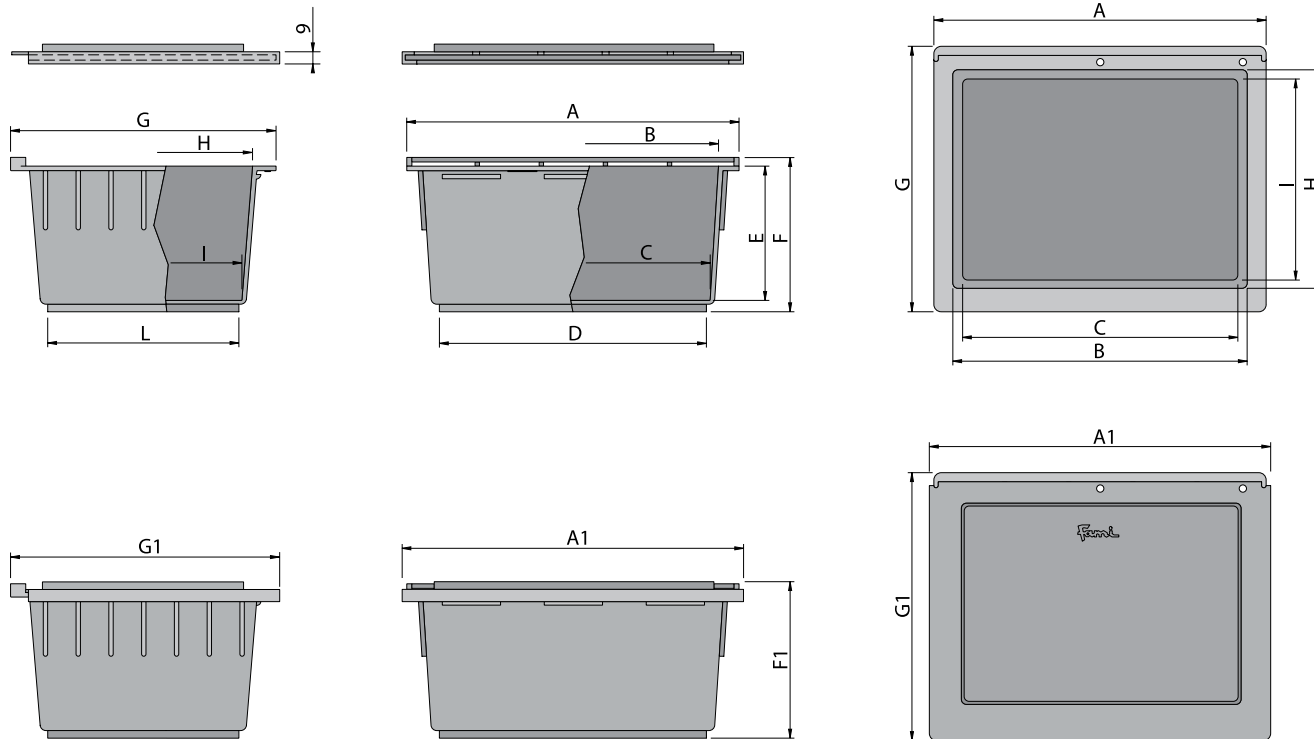

Detail of
SOLID
BOTTOM





SOLID BOTTOM



ORD. NO. F PH 3651 AC 01 -single

Standard colour: 01 grey ■

Batch of: 50 pcs.

Weight gr.: 360

External nominal dim. mm: 227×180×100 h

Internal nominal dim. mm: 188×136×92 h

ORD. NO. F PH 4851 AC 01 -single

Standard colour: 01 grey ■

Batch of: 25 pcs.

Weight gr.: 672

External nominal dim. mm: 336×231×100 h

Internal nominal dim. mm: 180×285×88 h



SOLID BOTTOM



ORD. NO. F PH 5251 AC 01 -single

Standard colour: 01 grey ■

Batch of: 30 pcs.

Weight gr.: 714

External nominal dim. mm: 336×231×150 h

Internal nominal dim. mm: 176×282×143 h



SOLID BOTTOM



SECURITY SHELL

Produced in **Polypropylene**, the **Security Shell** series is an **ideal solution** for **securely transporting** small items.



04 BLUE

| container ORD. NO. | A | A1 | B | C | D | D1 | E | F | G | H | I |
|------------------------|-----|-----|----|----|----|----|----|----|-----|-----|-----|
| F PH 0C51 00 04 | 222 | 110 | 87 | 84 | 14 | 19 | 25 | 28 | 148 | 126 | 124 |

The technical data contained in the above table is approximate. FAMI S.r.l. reserves the right to make any modifications it sees fit to improve the performance and appearance of products. The manufacturer is not liable for any printing errors.

F PH 0C51 00 04

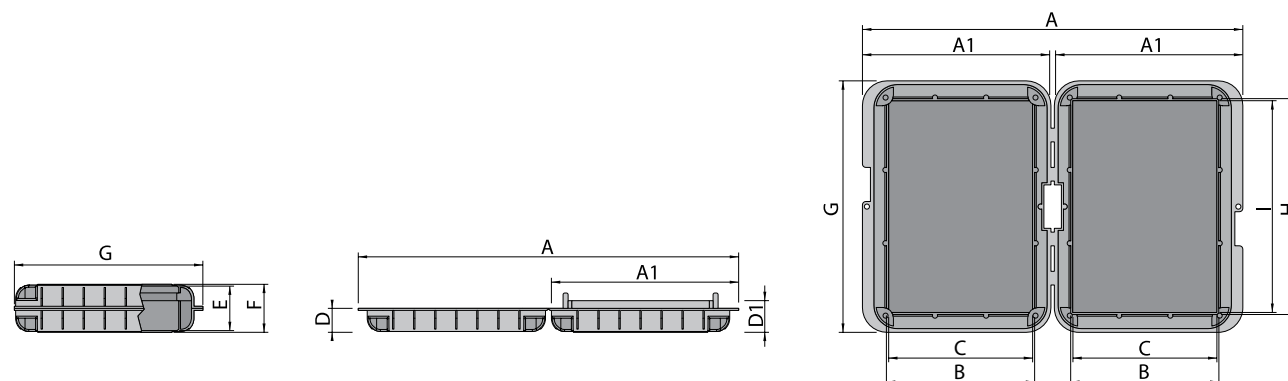

Detail of
SOLID
BOTTOM



| container ORD. NO. | A | B | C | D | E | F | F1 | G | H | I | L |
|------------------------|-----|-----|-----|-----|----|----|----|----|----|----|----|
| F PH CB51 00 04 | 148 | 129 | 128 | 132 | 35 | 49 | 54 | 98 | 80 | 79 | 81 |

The technical data contained in the above table is approximate. FAMI S.r.l. reserves the right to make any modifications it sees fit to improve the performance and appearance of products. The manufacturer is not liable for any printing errors.

F PH CB51 00 04

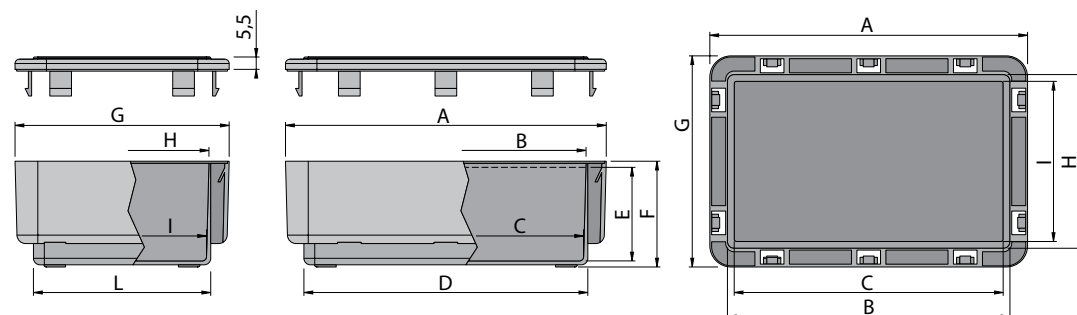

with the cover closed

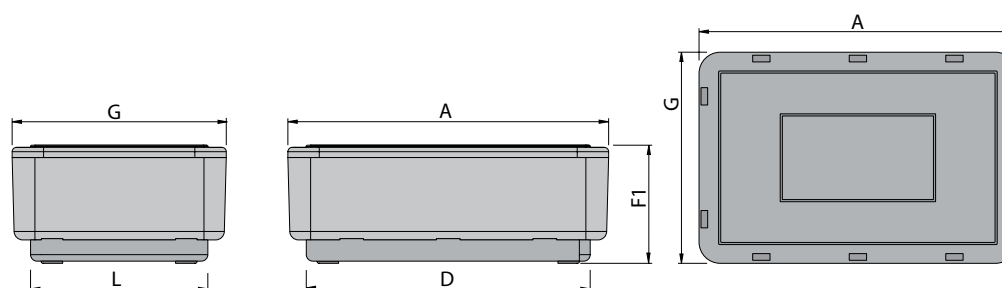

E5





ORD. NO. F PH 0C51 00 04 **-single**

Standard colour: 04 blue ■

Batch of: 300 pcs.

Weight gr.: 52

External nominal dim. mm: 148x110x28 h

Internal nominal dim. mm: 84x124x25 h

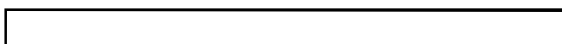

SOLID BOTTOM



ORD. NO. F PH CB51 00 04 **-single**

Standard colour: 04 blue ■

Batch of: 180 pcs.

Weight gr.: 124

External nominal dim. mm: 148x98x54 h

Internal nominal dim. mm: 128x79x35 h

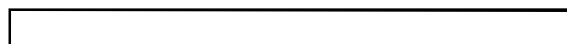

SOLID BOTTOM



STACKING CONTAINERS SERIES
NETTUNO



The **collapsible stacking containers** were specifically designed and produced to considerably **reduce space** when not in use and when being transported empty. The **reduction** in their volume up to 80% therefore allows **considerable savings** in **storage** and **transport** costs. Made from **top quality polypropylene**, these collapsible storage containers feature a tough stacking **edge** and external walls **ribbed** in the critical points. These structural features make the storage containers **very long-lasting**. **Light** and **manoeuvrable**, they adapt perfectly to standardised **pallets** and thanks to the flat bottom they can be used on **all types of roller conveyors**. The collapsible storage containers are therefore extremely **flexible** also for in-house handling. When **not in use**, they can be **folded** and stored without taking up a lot of warehouse space. The collapsible storage containers are available with a **hinged cover** attached to the long sides; they are fitted with a handy **label holder** and comfortable **handles** that make them easy to grip. Just like all polypropylene stacking containers, the collapsible storage containers are also **totally recyclable**.

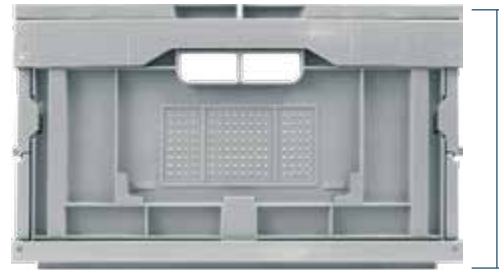

ratio 1:6



system for opening and closing the container



solid bottom



hinged lid



lifting handles



label holder

holes for fitting cover

NETTUNO 400x300

Produced in **Polypropylene**, the **collapsible** containers **400x300 mm** are made with solid **sides** and **bottom** with a **handle** on the short sides. They can be closed with a **cover**.

01 GREY
04 BLUE

| container ORD. NO. | A | B | C | D | E | F | G | H | I | L |
|--------------------|-----|-----|-----|-----|-----|-----|-----|-----|-----|-----|
| F PF 4851 BB.. | 397 | 366 | 356 | 360 | 200 | 218 | 297 | 267 | 255 | 260 |
| F PF 4851 BA.. | 397 | 366 | 356 | 360 | 218 | 229 | 297 | 267 | 255 | 260 |

The technical data contained in the above table is approximate. FAMI S.r.l. reserves the right to make any modifications it sees fit to improve the performance and appearance of products. The manufacturer is not liable for any printing errors.



SPECIAL LABELS

Page Q1

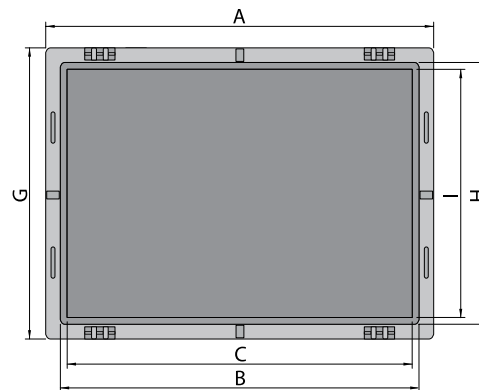
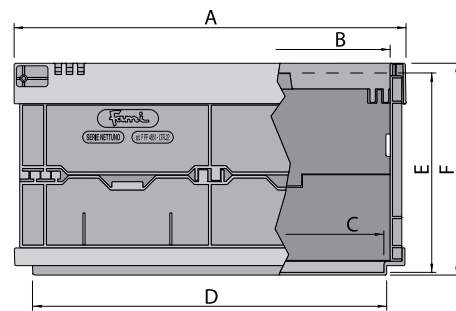
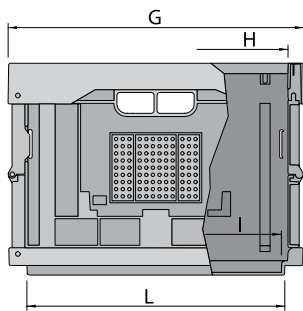

Detail of
**SOLID
BOTTOM**





SOLID BOTTOM



ORD. NO. F PF 4851 BB 01 -single

Standard colour: 01 grey ■ 04 blue ■

Weight gr.: 1016

External nominal dim. mm: 400×300×220 h

Internal nominal dim. mm: 356×255×200 h

ORD. NO. FYF 4851 BB 01 -pallet

Weight of pallet kg: 369

Qty. Containers per pallet: 350 pcs.

Shipping dimensions mm: 1200×1000×2210 h



SOLID BOTTOM



ORD. NO. F PF 4851 BA 01 -single

Standard colour: 01 grey ■ 04 blue ■

Weight gr.: 1312

External nominal dim. mm: 400×300×230 h

Internal nominal dim. mm: 356×255×218 h

ORD. NO. FYF 4851 BA 01 -pallet

Weight of pallet kg: 394

Qty. Containers per pallet: 290 pcs.

Shipping dimensions mm: 1200×1000×2210 h

Complete with **hinged lid**

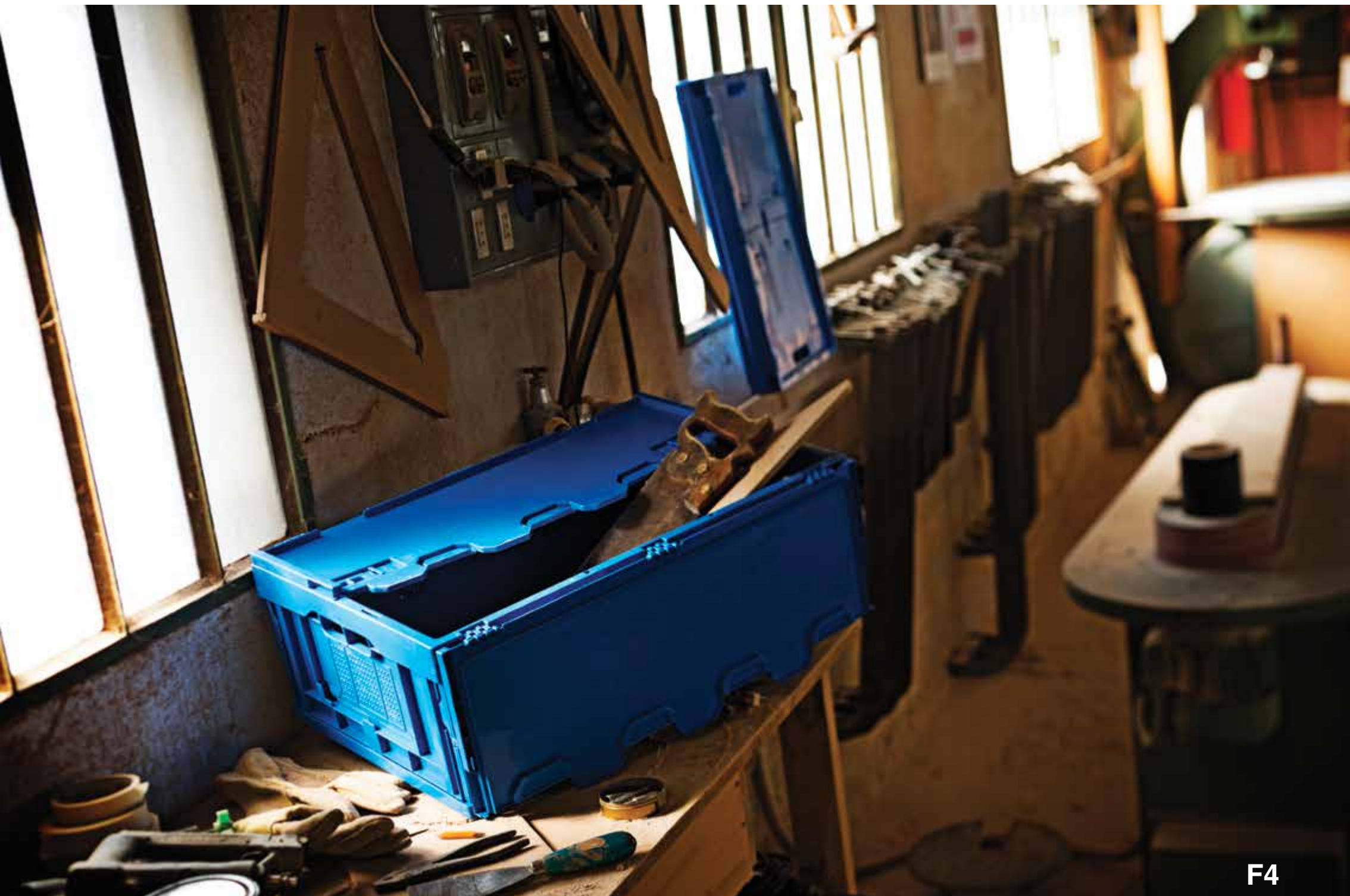

NETTUNO

600x400

Produced in **Polypropylene**, the **collapsible** containers **600x400** mm are made with solid **sides** and **bottom** with a **handle** on the short sides. They can be closed with a **hinged cover**.

OF GREY
04 BLUE



| container ORD. NO. | A | B | C | D | E | F | G | H | I | L |
|--------------------|-----|-----|-----|-----|-----|-----|-----|-----|-----|-----|
| F PF 6851 BB.. | 594 | 563 | 551 | 556 | 204 | 216 | 396 | 364 | 355 | 357 |
| F PF 6851 BA.. | 594 | 562 | 552 | 557 | 218 | 229 | 396 | 364 | 353 | 359 |
| F PF 7651 BB.. | 595 | 563 | 552 | 558 | 304 | 317 | 397 | 365 | 352 | 359 |
| F PF 7651 BA.. | 595 | 563 | 552 | 557 | 319 | 330 | 397 | 365 | 353 | 358 |

The technical data contained in the above table is approximate. FAMI S.r.l. reserves the right to make any modifications it sees fit to improve the performance and appearance of products. The manufacturer is not liable for any printing errors.

SPECIAL LABELS
Page Q1

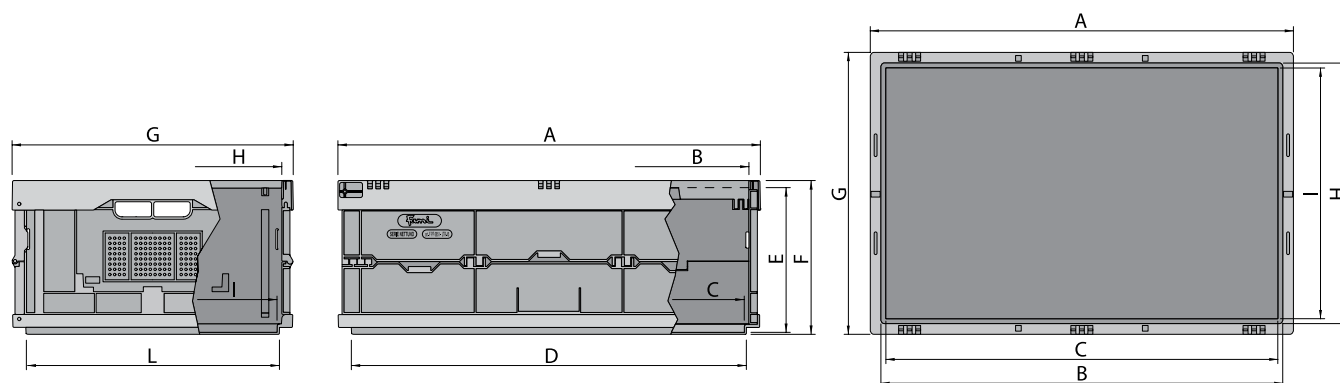

F5



SOLID BOTTOM

ORD. NO. F PF 6851 BB 01 -single

Standard colour: 01 grey 04 blue

Weight gr.: 1824

External nominal dim. mm: 600x400x220 h

Internal nominal dim. mm: 551x355x204 h

ORD. NO. FYF 6851 BB 01 -pallet

Weight of pallet kg: 342

Qty. Containers per pallet: 180 pcs.

Shipping dimensions mm: 1200x1000x2230 h



SOLID BOTTOM

ORD. NO. F PF 6851 BA 01 -single

Standard colour: 01 grey 04 blue

Weight gr.: 2535

External nominal dim. mm: 600x400x230 h

Internal nominal dim. mm: 552x353x218 h

ORD. NO. FYF 6851 BA 01 -pallet

Weight of pallet kg: 394

Qty. Containers per pallet: 150 pcs.

Shipping dimensions mm: 1200x1000x2230 h

Complete with hinged lid



SOLID BOTTOM

ORD. NO. F PF 7651 BB 01 -single

Standard colour: 01 grey 04 blue

Weight gr.: 2445

External nominal dim. mm: 600x400x320 h

Internal nominal dim. mm: 552x352x304 h

ORD. NO. FYF 7651 BB 01 -pallet

Weight of pallet kg: 454

Qty. Containers per pallet: 180 pcs.

Shipping dimensions mm: 1200x1000x2230 h



SOLID BOTTOM

ORD. NO. F PF 7651 BA 01 -single

Standard colour: 01 grey 04 blue

Weight gr.: 2985

External nominal dim. mm: 600x400x330 h

Internal nominal dim. mm: 552x353x319 h

ORD. NO. FYF 7651 BA 01 -pallet

Weight of pallet kg: 461

Qty. Containers per pallet: 150 pcs.

Shipping dimensions mm: 1200x1000x2230 h

Complete with hinged lid

STACKING CONTAINERS SERIES MINERVA



Made from **grey polypropylene**, the **Minerva** series stacking containers have a **truncated cone** shape: when fully loaded they can be **stacked firmly** and **safely**, when they are empty they can be stacked **one inside the other** with a reduction of **2/3** of their **volume**. They are used to **optimize** warehouse **space** and in **transportation** where it is necessary to reduce the **transport volumes** of the containers when they are **empty**.

These are produced in **three models** each of which can be **stacked together** with the others, in versions with **solid** or **perforated** bottom and walls. They are made with **lifting holes** that ensure an **easy grip** even when wearing gloves. The series **Minerva** stacking containers can be closed with a special **polypropylene cover** that allow them to be **stacked**. Designed to satisfy the most involved **handling requirements**, the Minerva stacking containers comply with standardised **European measurements (600x400)** and can therefore be **palletised**. The series Minerva stacking containers are suitable for **foodstuffs**.

The standardization of **reusable containers**, especially for consumer goods, is a basic requirement to **economically** and **ecologically** transport **goods**. It is important that the systems and containers meet the following requirements:

- **Reduction** of **space** when transported **empty**, ie **without load**;
- Space **optimized** inside the **truck**;
- **Optimization** of **transport** flows.

lifting

LifTiNG hole



walls

SOLId side walls



PERFORATED side walls



bottoms

SOLId bottom



PERFORATED bottom



stacking

front view



FULL empty

side view with cover



FULL

without cover



FULL



empty



interlocking details

stacking container combinations

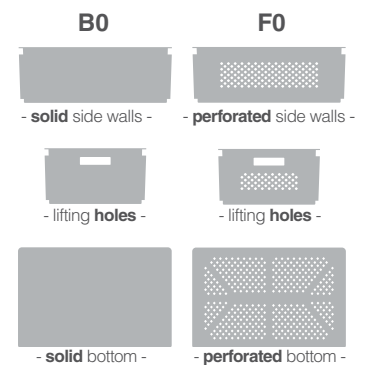

MINERVA 600x400

The polypropylene Minerva series containers 600x400 mm are available in 6 models and equipped with a lid that allows for stacking.

OF GREY

| container ORD. NO. | A | B | C | D | E | F | G | H | I | L | M | N | O | P |
|--------------------|-----|-----|-----|-----|-----|-----|-----|-----|-----|-----|-----|-----|-----|-----|
| F PE 6851 B0 01 | 601 | 524 | 455 | 536 | 178 | 201 | 399 | 371 | 338 | 345 | 220 | 202 | 141 | 60 |
| F PE 6851 F0 01 | 601 | 524 | 455 | 535 | 178 | 201 | 398 | 368 | 338 | 345 | 219 | 202 | 141 | 60 |
| F PE 7651 B0 01 | 602 | 527 | 453 | 537 | 272 | 301 | 398 | 370 | 338 | 346 | 220 | 202 | 214 | 86 |
| F PE 7651 F0 01 | 601 | 525 | 455 | 536 | 273 | 300 | 398 | 370 | 336 | 345 | 220 | 202 | 214 | 86 |
| F PE 8051 B0 01 | 602 | 526 | 453 | 535 | 372 | 401 | 398 | 367 | 336 | 345 | 218 | 203 | 284 | 117 |
| F PE 8051 F0 01 | 601 | 526 | 454 | 535 | 374 | 401 | 399 | 370 | 337 | 344 | 220 | 202 | 285 | 117 |

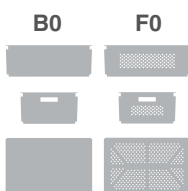

The technical data contained in the above table is approximate. FAMI S.r.l. reserves the right to make any modifications it sees fit to improve the performance and appearance of products. The manufacturer is not liable for any printing errors.

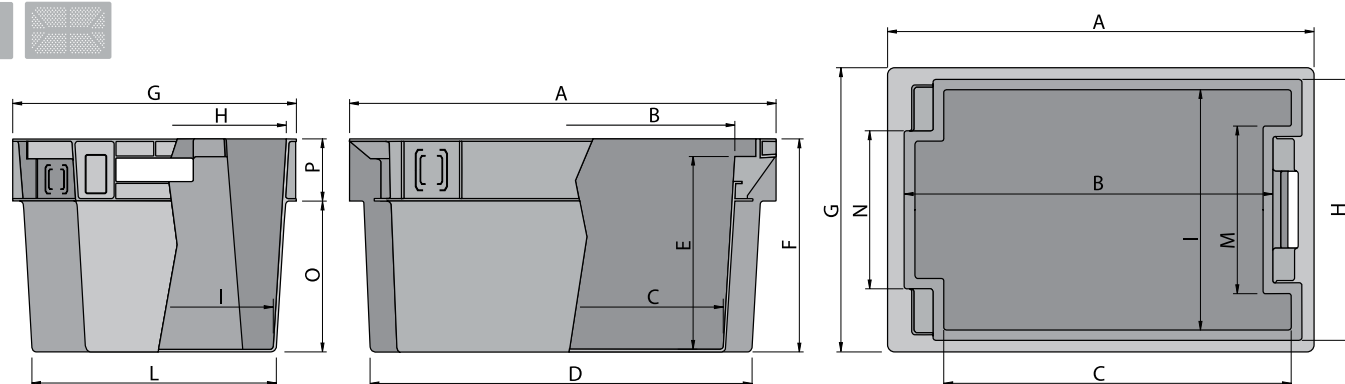

ACCESSORIES
PAGE
G5

Detail of
SOLID
BOTTOM



Detail of
PERFORATED
BOTTOM





SOLID BOTTOM

ORD. NO. F PE 6851 B0 01 -single

Measurements: 4620B
Standard colour: 01 grey ■

Weight gr.: 1650
External nominal dim. mm: 600x400x200 h
Internal nominal dim. mm: 455x338x178 h

ORD. NO. F YE 6851 B0 01 -pallet

Weight of pallet kg: 207
Qty. Containers per pallet: 120 pcs.
Shipping dimensions mm: 1200x800x2200 h



PERFORATED BOTTOM

ORD. NO. F PE 6851 F0 01 -single

Measurements: 4620F
Standard colour: 01 grey ■

Weight gr.: 1502
External nominal dim. mm: 600x400x200 h
Internal nominal dim. mm: 455x338x178 h

ORD. NO. F YE 6851 F0 01 -pallet

Weight of pallet kg: 189
Qty. Containers per pallet: 120 pcs.
Shipping dimensions mm: 1200x800x2200 h



SOLID BOTTOM

ORD. NO. F PE 7651 B0 01 -single

Measurements: 4630B
Standard colour: 01 grey ■

Weight gr.: 2432
External nominal dim. mm: 600x400x300 h
Internal nominal dim. mm: 453x338x272 h

ORD. NO. F YE 7651 B0 01 -pallet

Weight of pallet kg: 204
Qty. Containers per pallet: 80 pcs.
Shipping dimensions mm: 1200x800x2070 h



PERFORATED BOTTOM

ORD. NO. F PE 7651 F0 01 -single

Measurements: 4630F
Standard colour: 01 grey ■

Weight gr.: 2294
External nominal dim. mm: 600x400x300 h
Internal nominal dim. mm: 455x336x273 h

ORD. NO. F YE 7651 F0 01 -pallet

Weight of pallet kg: 193
Qty. Containers per pallet: 80 pcs.
Shipping dimensions mm: 1200x800x2070 h



SOLID BOTTOM

ORD. NO. F PE 8051 B0 01 -single

Measurements: 4640B
Standard colour: 01 grey ■

Weight gr.: 2865
External nominal dim. mm: 600x400x400 h
Internal nominal dim. mm: 453x336x372 h

ORD. NO. F YE 8051 B0 01 -pallet

Weight of pallet kg: 181
Qty. Containers per pallet: 60 pcs.
Shipping dimensions mm: 1200x800x2200 h



PERFORATED BOTTOM

ORD. NO. F PE 8051 F0 01 -single

Measurements: 4640F
Standard colour: 01 grey ■

Weight gr.: 2654
External nominal dim. mm: 600x400x400 h
Internal nominal dim. mm: 454x337x374 h

ORD. NO. F YE 8051 F0 01 -pallet

Weight of pallet kg: 168
Qty. Containers per pallet: 60 pcs.
Shipping dimensions mm: 1200x800x2200 h

ACCESSORIES
MINERVA
600x400



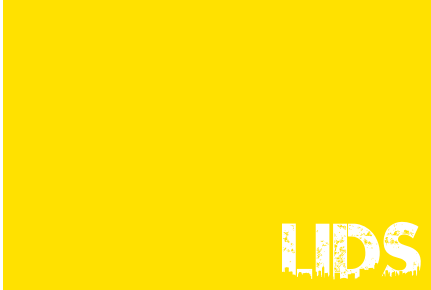

snap spring for lid closing
ORD. NO. F PZ 0020 00 99



| | |
|-----------------|---------|
| ORD. NO. | Lid mm |
| F PE 0951 00 01 | 600x400 |
| Weight gr. | 1000 |



01 GREY

METAL CLIPS

These metal clips can be **snapped** into the long or short sides of the **Minerva** stacking containers and are used to **keep documents in place**.



SPECIAL LABELS

Page Q1



| | |
|-----------------|----------|
| ORD. NO. | DIM. mm |
| F PZ 0010 00 99 | 75x20x20 |

example of metal clip **use**

fitting the metal clip **use**

99 HOT GALVANISED



G6

STACKING CONTAINERS SERIES

DELTA



H1



LiftinG

The flush handles offer a safe and easy grip even for gloved hands.



Stacking with **closed** cover



Nesting with **open** cover



Stacking support with **open** cover



Nesting with the **support**



Front View



SupPOrtS

The **support** (pic. 1) is pushed to **its stop** (pic. 2) and is **blocked** by **pressing downwards** (pic. 3).



support block

DELTA 600x400

The **polypropylene** series **Delta 600x400** mm containers are available in **3 heights** and can be use open or closed with a hinged cover.

OF GREY

| container ORD. NO. | A | B | C | D | E | F | G | H | I | L | O | P |
|--------------------|-----|-----|-----|-----|-----|-----|-----|-----|-----|-----|-----|-----|
| F PD 6851 A0 01 | 601 | 532 | 501 | 508 | 192 | 224 | 400 | 370 | 330 | 339 | 174 | 50 |
| F PD 7651 A0 01 | 601 | 540 | 501 | 509 | 292 | 325 | 401 | 373 | 330 | 339 | 245 | 81 |
| F PD 8051 A0 01 | 601 | 540 | 499 | 508 | 394 | 426 | 400 | 372 | 329 | 338 | 326 | 100 |
| F PD 6851 AB 01 | 601 | 532 | 501 | 508 | 192 | 229 | 400 | 370 | 330 | 339 | 174 | 50 |
| F PD 7651 AB 01 | 601 | 540 | 501 | 509 | 292 | 330 | 401 | 373 | 330 | 339 | 245 | 81 |
| F PD 8051 AB 01 | 601 | 540 | 499 | 508 | 394 | 431 | 400 | 372 | 329 | 338 | 326 | 100 |
| F PD 6851 AA 01 | 601 | 532 | 501 | 508 | 192 | 239 | 400 | 370 | 330 | 339 | 174 | 50 |
| F PD 7651 AA 01 | 601 | 540 | 501 | 509 | 292 | 340 | 401 | 373 | 330 | 339 | 245 | 81 |
| F PD 8051 AA 01 | 601 | 540 | 499 | 508 | 394 | 441 | 400 | 372 | 329 | 338 | 326 | 100 |

The technical data contained in the above table is approximate. FAMI S.r.l. reserves the right to make any modifications it sees fit to improve the performance and appearance of products. The manufacturer is not liable for any printing errors.

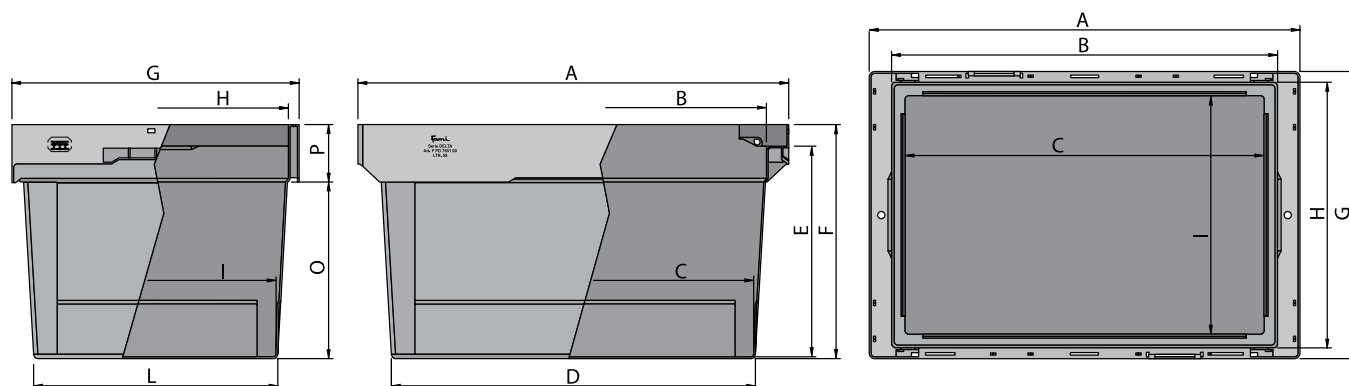

H3



SOLID BOTTOM

ORD. NO. F PD 6851 A0 01 -single

Measurements: 4620D
Standard colour: 01 grey ■

Weight gr.: 1706
External nominal dim. mm: 600x400x225 h
Internal nominal dim. mm: 501x330x192 h

ORD. NO. FYD 6851 A0 01 -pallet

Weight of pallet kg: 214
Qty. Containers per pallet: 120 pcs.
Shipping dimensions mm: 1200x800x1850 h



SOLID BOTTOM

ORD. NO. F PD 7651 A0 01 -single

Measurements: 4630D
Standard colour: 01 grey ■

Weight gr.: 2270
External nominal dim. mm: 600x400x325 h
Internal nominal dim. mm: 501x330x292 h

ORD. NO. FYD 7651 A0 01 -pallet

Weight of pallet kg: 145
Qty. Containers per pallet: 60 pcs.
Shipping dimensions mm: 1200x800x1600 h

ACCESSORIES
PAGE
H7



SOLID BOTTOM

ORD. NO. F PD 8051 A0 01 -single

Measurements: 4640D
Standard colour: 01 grey ■

Weight gr.: 2890
External nominal dim. mm: 600x400x425 h
Internal nominal dim. mm: 499x329x394 h

ORD. NO. FYD 8051 A0 01 -pallet

Weight of pallet kg: 125
Qty. Containers per pallet: 40 pcs.
Shipping dimensions mm: 1200x800x1500 h



SOLID BOTTOM

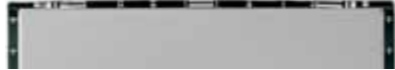

ORD. NO. F PD 6851 AB 01 -single

| | |
|------------------|-----------|
| Measurements: | 4620DS |
| Standard colour: | 01 grey ■ |

| | |
|---------------------------|---------------|
| Weight gr.: | 1992 |
| External nominal dim. mm: | 600×400×230 h |
| Internal nominal dim. mm: | 501×330×192 h |

ORD. NO. FYD 6851 AB 01 -pallet

| | |
|-----------------------------|-----------------|
| Weight of pallet kg: | 248 |
| Qty. Containers per pallet: | 120 pcs. |
| Shipping dimensions mm: | 1200×800×1850 h |



SOLID BOTTOM

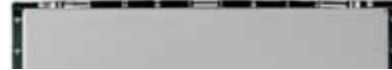

ORD. NO. F PD 7651 AB 01 -single

| | |
|------------------|-----------|
| Measurements: | 4630DS |
| Standard colour: | 01 grey ■ |

| | |
|---------------------------|---------------|
| Weight gr.: | 2486 |
| External nominal dim. mm: | 600×400×330 h |
| Internal nominal dim. mm: | 501×330×292 h |

ORD. NO. FYD 7651 AB 01 -pallet

| | |
|-----------------------------|-----------------|
| Weight of pallet kg: | 158 |
| Qty. Containers per pallet: | 60 pcs. |
| Shipping dimensions mm: | 1200×800×1600 h |



SOLID BOTTOM



ORD. NO. F PD 8051 AB 01 -single

| | |
|------------------|-----------|
| Measurements: | 4640DS |
| Standard colour: | 01 grey ■ |

| | |
|---------------------------|---------------|
| Weight gr.: | 3106 |
| External nominal dim. mm: | 600×400×430 h |
| Internal nominal dim. mm: | 499×329×394 h |

ORD. NO. FYD 8051 AB 01 -pallet

| | |
|-----------------------------|-----------------|
| Weight of pallet kg: | 133 |
| Qty. Containers per pallet: | 40 pcs. |
| Shipping dimensions mm: | 1200×800×1500 h |



SOLID BOTTOM



ORD. NO. F PD 6851 AA 01 -single

| | |
|------------------|-----------|
| Measurements: | 4620DC |
| Standard colour: | 01 grey ■ |

| | |
|---------------------------|---------------|
| Weight gr.: | 2606 |
| External nominal dim. mm: | 610×400×240 h |
| Internal nominal dim. mm: | 501×330×192 h |

ORD. NO. FYD 6851 AA 01 -pallet

| | |
|-----------------------------|------------------|
| Weight of pallet kg: | 116 |
| Qty. Containers per pallet: | 40 pcs. |
| Shipping dimensions mm: | 1300×1000×1600 h |



SOLID BOTTOM



ORD. NO. F PD 7651 AA 01 -single

| | |
|------------------|-----------|
| Measurements: | 4630DC |
| Standard colour: | 01 grey ■ |

| | |
|---------------------------|---------------|
| Weight gr.: | 3170 |
| External nominal dim. mm: | 610×400×340 h |
| Internal nominal dim. mm: | 501×330×292 h |

ORD. NO. FYD 7651 AA 01 -pallet

| | |
|-----------------------------|------------------|
| Weight of pallet kg: | 139 |
| Qty. Containers per pallet: | 40 pcs. |
| Shipping dimensions mm: | 1300×1000×1700 h |



SOLID BOTTOM



ORD. NO. F PD 8051 AA 01 -single

| | |
|------------------|-----------|
| Measurements: | 4640DC |
| Standard colour: | 01 grey ■ |

| | |
|---------------------------|---------------|
| Weight gr.: | 3790 |
| External nominal dim. mm: | 610×400×440 h |
| Internal nominal dim. mm: | 499×329×394 h |

ORD. NO. FYD 8051 AA 01 -pallet

| | |
|-----------------------------|------------------|
| Weight of pallet kg: | 164 |
| Qty. Containers per pallet: | 40 pcs. |
| Shipping dimensions mm: | 1300×1000×1800 h |



ACCESSORIES
PAGE
H7



H6

ACCESSORIES
DELTA
600x400





lid complete with **6 hinges** for the **Delta** series of storage containers



6 spare hinges for the **Delta** series of storage containers



| ORD. NO. | Weight gr. |
|-----------------|------------|
| F PD 1151 00 01 | 900 |

| ORD. NO. | R FPZ 0002 01 |
|----------|---------------|
|----------|---------------|

OT GREY

SUPPORTS



pair of supports for the Delta series of storage containers

| ORD. NO. | F PZ 8559 00 05 |
|----------|-----------------|
|----------|-----------------|

The lid can be fastened with a security seal



H8

The FAMI polypropylene stacking and storage containers have been designed and produced to offer companies rational solutions to their various material storage and handling requirements. First quality materials, together with detailed structural research are the basis for this top quality product. The wide range of containers is available in five colours to allow the storage of materials in easily recognisable categories.

stacking containers series page I3

ZEUS



storage containers series page J1

ZEUS - COMPAT



WITH OPEN FRONT



STACKING CONTAINERS SERIES
ZEUS





Zeus Series containers cater for any **specific storage** requirement. The Zeus containers are **light** and due to the smooth sides **clean easily**. The **sturdy** edge allows firm and safe **stacking**. Easy **stacking**, together with **elevated load capacity**, ensures the available warehouse space is **exploited** to the most and guarantees trouble-free **handling**.

Lifting

Lifting and Transportation. The stacking containers are fitted with handles for easy carrying even if the operator wears gloves.



Labels

The labels inserted in their relative holders allow the contents to be easily identified. Smaller label holders and larger ones for longer descriptions are also available.



LaTeRaL RiBBING

The lateral ribbing at the bottom of the FAMI polypropylene stacking and storage containers offer trouble-free stacking even when fully loaded.

SOLID BOTTOM

The stacking containers adapt perfectly to standard pallets and due to the smooth container base can be utilized on roller or belt conveyor systems while keeping the stored materials well protected and easy to access within the sturdy container.



available in five colours

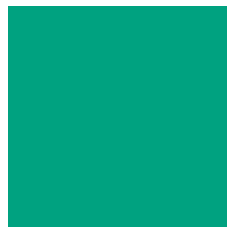
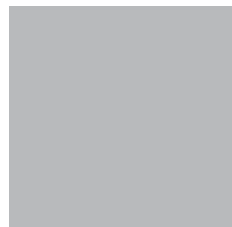

ZEUS



| container ORD. NO. | A | B | C | D | E | F | G | H | I | L |
|--------------------|-----|-----|-----|-----|-----|-----|-----|-----|-----|-----|
| F PJ 0151 00 04 | 144 | 127 | 123 | 137 | 63 | 70 | 91 | 84 | 81 | 84 |
| F PJ 1751 00 04 | 144 | 126 | 124 | 137 | 63 | 70 | 139 | 132 | 126 | 132 |
| F PJ 2551 00.. | 211 | 178 | 187 | 202 | 110 | 123 | 148 | 129 | 125 | 140 |
| F PJ 3351 00.. | 311 | 255 | 284 | 303 | 130 | 144 | 209 | 184 | 182 | 201 |
| F PJ 5751 00.. | 463 | 427 | 423 | 453 | 105 | 120 | 313 | 277 | 275 | 304 |
| F PJ 6551 00.. | 464 | 403 | 425 | 452 | 181 | 197 | 312 | 288 | 277 | 301 |
| F PJ 7351 00.. | 466 | 407 | 426 | 453 | 285 | 301 | 314 | 281 | 276 | 302 |
| F PJ 8951 00.. | 655 | 570 | 604 | 638 | 276 | 299 | 471 | 435 | 429 | 458 |

The technical data contained in the above table is approximate. FAMI S.r.l. reserves the right to make any modifications it sees fit to improve the performance and appearance of products. The manufacturer is not liable for any printing errors.



Detail of
**SOLID
BOTTOM**

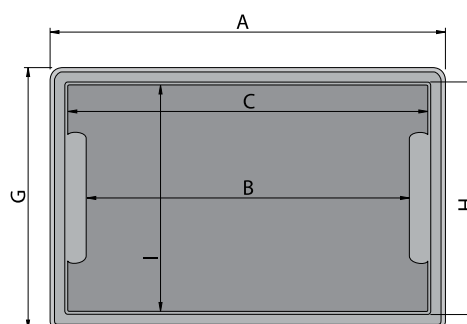
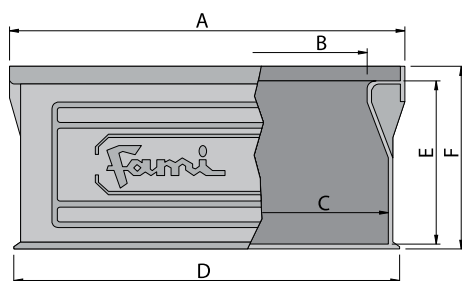
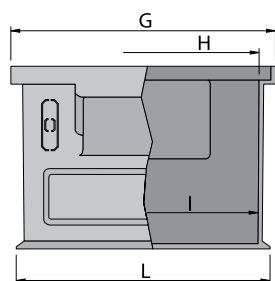

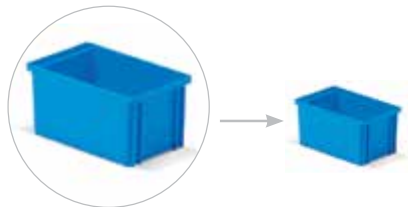

SOLID BOTTOM



ORD. NO. F PJ 0151 00 04 **-single**

| | |
|------------------|---------------------------------------------|
| Measurements: | 701 |
| Standard colour: | 04 blue ■ |
| Batch of: | 50 pcs. |

| | |
|---------------------------|-------------|
| Weight gr.: | 66 |
| External nominal dim. mm: | 145×90×70 h |
| Internal nominal dim. mm: | 123×81×63 h |

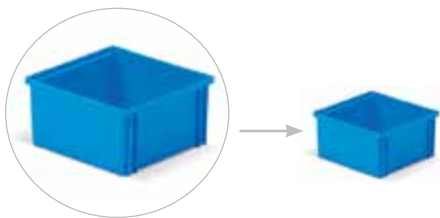

SOLID BOTTOM



ORD. NO. F PJ 1751 00 04 **-single**

| | |
|------------------|---------------------------------------------|
| Measurements: | 702 |
| Standard colour: | 04 blue ■ |
| Batch of: | 54 pcs. |

| | |
|---------------------------|--------------|
| Weight gr.: | 106 |
| External nominal dim. mm: | 145×140×70 h |
| Internal nominal dim. mm: | 124×126×63 h |



ACCESSORIES
PAGE
17



SOLID BOTTOM



ORD. NO. F PJ 2551 00 01 **-single**

| | |
|------------------|-------------------------------------------|
| Measurements: | 272-2PL1 |
| Standard colour: | 01 grey 02 green 03 red 04 blue 05 yellow |
| Batch of: | 54 pcs. |

| | |
|---------------------------|---------------|
| Weight gr.: | 264 |
| External nominal dim. mm: | 200×140×130 h |
| Internal nominal dim. mm: | 187×125×110 h |

ORD. NO. FYJ 2551 00 01 **-pallet**

| | |
|-----------------------------|------------------|
| Weight of pallet kg: | 239 |
| Qty. Containers per pallet: | 810 pcs. |
| Shipping dimensions mm: | 1400×1100×1660 h |



SOLID BOTTOM



ORD. NO. F PJ 3351 00 02 -single

| | |
|------------------------------------------------------------|------------|
| Measurements: | 272-3A2PL2 |
| Standard colour: 01 grey 02 green 03 red 04 blue 05 yellow | |
| Batch of: | 21 pcs. |

| | |
|---------------------------|---------------|
| Weight gr.: | 522 |
| External nominal dim. mm: | 300×200×145 h |
| Internal nominal dim. mm: | 284×182×130 h |

ORD. NO. FYJ 3351 00 02 -pallet

| | |
|-----------------------------|------------------|
| Weight of pallet kg: | 163 |
| Qty. Containers per pallet: | 252 pcs. |
| Shipping dimensions mm: | 1350×1000×2000 h |



SOLID BOTTOM



ORD. NO. F PJ 5751 00 04 -single

| | |
|------------------------------------------------------------|------------|
| Measurements: | 272-4A2PL4 |
| Standard colour: 01 grey 02 green 03 red 04 blue 05 yellow | |
| Batch of: | 16 pcs. |

| | |
|---------------------------|---------------|
| Weight gr.: | 972 |
| External nominal dim. mm: | 450×300×120 h |
| Internal nominal dim. mm: | 423×275×105 h |

ORD. NO. FYJ 5751 00 04 -pallet

| | |
|-----------------------------|------------------|
| Weight of pallet kg: | 136 |
| Qty. Containers per pallet: | 128 pcs. |
| Shipping dimensions mm: | 1300×1000×1900 h |



SOLID BOTTOM



ORD. NO. F PJ 6551 00 05 -single

| | |
|------------------------------------------------------------|----------|
| Measurements: | 272-4PL5 |
| Standard colour: 01 grey 02 green 03 red 04 blue 05 yellow | |
| Batch of: | 10 pcs. |

| | |
|---------------------------|---------------|
| Weight gr.: | 1270 |
| External nominal dim. mm: | 450×300×200 h |
| Internal nominal dim. mm: | 425×277×181 h |

ORD. NO. FYJ 6551 00 05 -pallet

| | |
|-----------------------------|------------------|
| Weight of pallet kg: | 114 |
| Qty. Containers per pallet: | 80 pcs. |
| Shipping dimensions mm: | 1300×1000×2000 h |



SOLID BOTTOM



ORD. NO. F PJ 7351 00 01 -single

| | |
|------------------------------------------------------------|------------|
| Measurements: | 272-4A5PL1 |
| Standard colour: 01 grey 02 green 03 red 04 blue 05 yellow | |

| | |
|---------------------------|---------------|
| Weight gr.: | 1824 |
| External nominal dim. mm: | 450×300×300 h |
| Internal nominal dim. mm: | 426×276×285 h |

ORD. NO. FYJ 7351 00 01 -pallet

| | |
|-----------------------------|------------------|
| Weight of pallet kg: | 114 |
| Qty. Containers per pallet: | 56 pcs. |
| Shipping dimensions mm: | 1300×1000×2160 h |



SOLID BOTTOM



ORD. NO. F PJ 8951 00 03 -single

| | |
|------------------------------------------------------------|----------|
| Measurements: | 272-5PL3 |
| Standard colour: 01 grey 02 green 03 red 04 blue 05 yellow | |

| | |
|---------------------------|---------------|
| Weight gr.: | 4355 |
| External nominal dim. mm: | 630×450×300 h |
| Internal nominal dim. mm: | 604×429×276 h |

ORD. NO. FYJ 8951 00 03 -pallet

| | |
|-----------------------------|------------------|
| Weight of pallet kg: | 134 |
| Qty. Containers per pallet: | 28 pcs. |
| Shipping dimensions mm: | 1300×1000×2110 h |

LABELS

Proportional to the size of the containers to which they are applied.



| label sheet | for stacking container ORD. NO. |
|-----------------|----------------------------------------------------|
| F PL 9160 00 00 | F PJ 6551 00.. F PJ 7351 00.. F PJ 8951 00.. |
| F PL 9140 00 00 | F PJ 5751 00.. |

| size of label Art. F PL 9160 00 00 | number of labels per sheet |
|---------------------------------------|----------------------------|
| 189x85 | 3 |
| size of label Art. F PL 9140 00 00 | number of labels per sheet |
| 189x82 | 3 |

The technical data contained in the above table is approximate. FAMI S.r.l. reserves the right to make any modifications it sees fit to improve the performance and appearance of products. The manufacturer is not liable for any printing errors.

SPECIAL LABELS

Page Q1



STORAGE CONTAINERS SERIES ZEUS-COMPAT

The design and construction of Fami boxes and containers are based on years of market experience and client feedback.



The **polypropylene** stacking containers of the **Zeus** and **Compat** series are the perfect solution for all **storage** problems both in the **warehouse** and the **workshop**. They are designed to keep various components close at hand and easily accessible. These containers can be **firmly** and **safely stacked** and the material they contain is **easy to access** even when they are **stacked**.

Lifting

Lifting and Transportation.
The stacking containers are fitted with handles for easy carrying even if the operator wears gloves.



Labels

The labels inserted in their relative holders allow the contents to be easily identified. Smaller label holders and larger ones for longer descriptions are also available.



LaTeRaL RiBBING

The lateral ribbing at the bottom of the FAMI polypropylene stacking and storage containers offer trouble-free stacking even when fully loaded.

ZEUS & COMPAT

The Compat version features double front walls that ensure maximum stability even when stacked. A carrying bar is fixed with self-threading screws to all the series Zeus containers. This prevents the side walls from deforming under heavy loads and makes the container easier to carry.



available in five colours

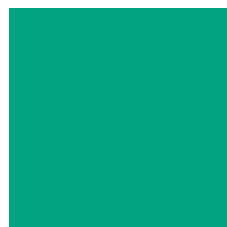
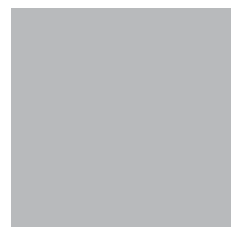

ZEUS COMPAT



zeus

| container ORD. NO. | A | B | C | D | E | F | G | H | I | L | M | N | P |
|--------------------|-----|-----|-----|-----|-----|-----|-----|-----|-----|-----|-----|-----|-----|
| F PL 0151 00.. | 77 | 55 | 55 | 59 | 32 | 37 | 50 | 40 | 39 | 47 | 18 | 15 | |
| F PL 0951 00.. | 93 | 63 | 63 | 67 | 44 | 52 | 103 | 92 | 90 | 99 | 27 | 21 | |
| F PL 4951 00.. | 352 | 295 | 295 | 307 | 131 | 146 | 469 | 439 | 432 | 455 | 75 | 60 | |
| F PL 8151 00.. | 535 | 412 | 433 | 452 | 277 | 300 | 472 | 436 | 430 | 459 | 151 | 132 | 362 |
| F PL 8951 00.. | 720 | 598 | 618 | 636 | 276 | 300 | 471 | 434 | 428 | 459 | 150 | 131 | 545 |

The technical data contained in the above table is approximate. FAMI S.r.l. reserves the right to make any modifications it sees fit to improve the performance and appearance of products. The manufacturer is not liable for any printing errors.

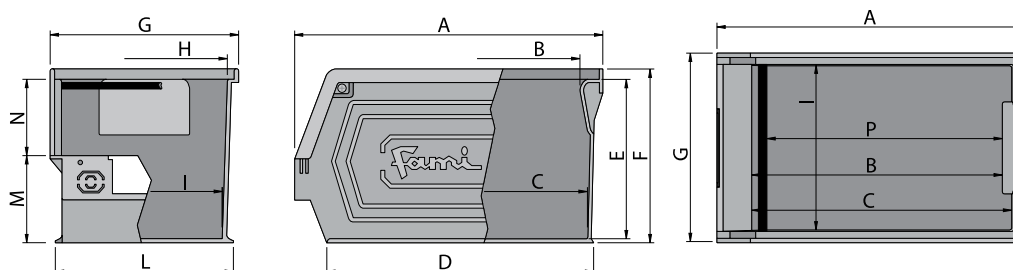

compat

| container ORD. NO. | A | B | C | D | E | F | G | H | I | L | M | N |
|--------------------|-----|-----|-----|-----|-----|-----|-----|-----|-----|-----|-----|-----|
| F PM 1751 00.. | 169 | 134 | 134 | 136 | 66 | 75 | 102 | 88 | 87 | 96 | 35 | 34 |
| F PM 2551 00.. | 235 | 193 | 193 | 202 | 111 | 122 | 149 | 128 | 125 | 141 | 61 | 52 |
| F PM 3351 00.. | 342 | 272 | 285 | 296 | 130 | 142 | 209 | 185 | 182 | 201 | 71 | 61 |
| F PM 4151 00.. | 347 | 269 | 279 | 291 | 186 | 200 | 209 | 181 | 178 | 200 | 99 | 90 |
| F PM 5751 00.. | 501 | 427 | 440 | 450 | 129 | 143 | 311 | 284 | 279 | 300 | 75 | 60 |
| F PM 6551 00.. | 500 | 425 | 436 | 443 | 185 | 200 | 312 | 285 | 281 | 303 | 100 | 88 |
| F PM 7351 00.. | 501 | 423 | 433 | 445 | 286 | 301 | 313 | 284 | 279 | 302 | 150 | 141 |

The technical data contained in the above table is approximate. FAMI S.r.l. reserves the right to make any modifications it sees fit to improve the performance and appearance of products. The manufacturer is not liable for any printing errors.

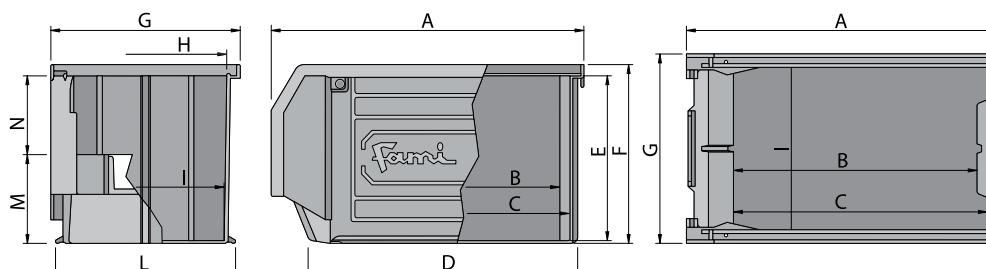

J3

ACCESSORIES
PAGE
J7



Detail of
SOLID
BOTTOM



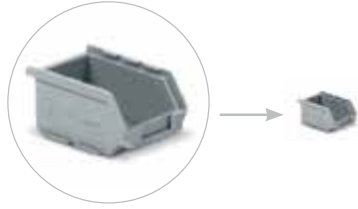

| | |
|---------------------------------|-------------------------------------------|
| ORD. NO. F PL 0151 00 01 | -single |
| Measurements: | 01PL-Z1 |
| Standard colour: | 01 grey 02 green 03 red 04 blue 05 yellow |
| Batch of: | 100 pcs. |
| Weight gr.: | 18 |
| External nominal dim. mm: | 72/60×45×32 h |
| Internal nominal dim. mm: | 55×39×32 h |

SOLID BOTTOM

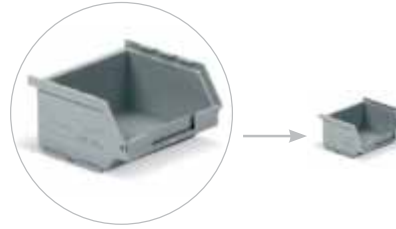

| | |
|---------------------------------|-------------------------------------------|
| ORD. NO. F PL 0951 00 01 | -single |
| Measurements: | 0PL-Z1 |
| Standard colour: | 01 grey 02 green 03 red 04 blue 05 yellow |
| Batch of: | 50 pcs. |
| Weight gr.: | 38 |
| External nominal dim. mm: | 85/65×95×45 h |
| Internal nominal dim. mm: | 63×90×44 h |

SOLID BOTTOM



| | |
|---------------------------------|-------------------------------------------|
| ORD. NO. F PM 1751 00 04 | -single |
| Measurements: | 1PL-C4 |
| Standard colour: | 01 grey 02 green 03 red 04 blue 05 yellow |
| Batch of: | 50 pcs. |
| Weight gr.: | 78 |
| External nominal dim. mm: | 160/140×95×75 h |
| Internal nominal dim. mm: | 134×87×66 h |

SOLID BOTTOM



| | |
|---------------------------------|-------------------------------------------|
| ORD. NO. F PM 2551 00 05 | -single |
| Measurements: | 2PL-C5 |
| Standard colour: | 01 grey 02 green 03 red 04 blue 05 yellow |
| Batch of: | 54 pcs. |
| Weight gr.: | 214 |
| External nominal dim. mm: | 230/200×140×130 h |
| Internal nominal dim. mm: | 193×125×111 h |

SOLID BOTTOM



| | |
|---------------------------------|------------------|
| ORD. NO. F YM 1751 00 04 | -pallet |
| Weight of pallet kg: | 167 |
| Qty. Containers per pallet: | 1750 pcs. |
| Shipping dimensions mm: | 1300×1100×2000 h |

| | |
|---------------------------------|------------------|
| ORD. NO. F YM 2551 00 05 | -pallet |
| Weight of pallet kg: | 265 |
| Qty. Containers per pallet: | 1080 pcs. |
| Shipping dimensions mm: | 1450×1200×2100 h |



| | |
|---------------------------------|-------------------------------------------|
| ORD. NO. F PM 3351 00 03 | -single |
| Measurements: | 3A2PL-C3 |
| Standard colour: | 01 grey 02 green 03 red 04 blue 05 yellow |
| Batch of: | 21 pcs. |
| Weight gr.: | 598 |
| External nominal dim. mm: | 350/300×200×145 h |
| Internal nominal dim. mm: | 272×182×130 h |

SOLID BOTTOM



| | |
|---------------------------------|-------------------------------------------|
| ORD. NO. F PM 4151 00 01 | -single |
| Measurements: | 3PL-C1 |
| Standard colour: | 01 grey 02 green 03 red 04 blue 05 yellow |
| Batch of: | 15 pcs. |
| Weight gr.: | 784 |
| External nominal dim. mm: | 350/300×200×200 h |
| Internal nominal dim. mm: | 269×178×186 h |

SOLID BOTTOM



| | |
|---------------------------------|------------------|
| ORD. NO. F YM 4151 00 01 | -pallet |
| Weight of pallet kg: | 153 |
| Qty. Containers per pallet: | 180 pcs. |
| Shipping dimensions mm: | 1300×1000×2000 h |



SOLID BOTTOM



ORD. NO. F PL 4951 00 02 -single

| | |
|------------------|-------------------------------------------|
| Measurements: | 3L5PL-Z2 |
| Standard colour: | 01 grey 02 green 03 red 04 blue 05 yellow |
| Batch of: | 14 pcs. |

| | |
|---------------------------|-------------------|
| Weight gr.: | 1074 |
| External nominal dim. mm: | 350/300×450×145 h |
| Internal nominal dim. mm: | 295×432×131 h |

ORD. NO. FYL 4951 00 02 -pallet

| | |
|-----------------------------|------------------|
| Weight of pallet kg: | 145 |
| Qty. Containers per pallet: | 112 pcs. |
| Shipping dimensions mm: | 1450×1000×2100 h |



SOLID BOTTOM



ORD. NO. F PM 5751 00 01 -single

| | |
|------------------|-------------------------------------------|
| Measurements: | 4A2PL-C1 |
| Standard colour: | 01 grey 02 green 03 red 04 blue 05 yellow |
| Batch of: | 14 pcs. |

| | |
|---------------------------|-------------------|
| Weight gr.: | 1222 |
| External nominal dim. mm: | 500/450×300×145 h |
| Internal nominal dim. mm: | 427×279×129 h |

ORD. NO. FYM 5751 00 01 -pallet

| | |
|-----------------------------|------------------|
| Weight of pallet kg: | 149 |
| Qty. Containers per pallet: | 112 pcs. |
| Shipping dimensions mm: | 1300×1000×2000 h |

ORD. NO. F PM 6551 00 05 -single

| | |
|------------------|-------------------------------------------|
| Measurements: | 4PL-C5 |
| Standard colour: | 01 grey 02 green 03 red 04 blue 05 yellow |
| Batch of: | 10 pcs. |

| | |
|---------------------------|-------------------|
| Weight gr.: | 1335 |
| External nominal dim. mm: | 500/450×300×200 h |
| Internal nominal dim. mm: | 425×281×185 h |

ORD. NO. FYM 6551 00 05 -pallet

| | |
|-----------------------------|------------------|
| Weight of pallet kg: | 119 |
| Qty. Containers per pallet: | 80 pcs. |
| Shipping dimensions mm: | 1300×1000×2000 h |



SOLID BOTTOM



SOLID BOTTOM



ORD. NO. F PM 7351 00 01 -single

| | |
|------------------|-------------------------------------------|
| Measurements: | 4A5PL-C1 |
| Standard colour: | 01 grey 02 green 03 red 04 blue 05 yellow |

| | |
|---------------------------|-------------------|
| Weight gr.: | 1874 |
| External nominal dim. mm: | 500/450×300×300 h |
| Internal nominal dim. mm: | 423×279×286 h |

ORD. NO. FYM 7351 00 01 -pallet

| | |
|-----------------------------|------------------|
| Weight of pallet kg: | 117 |
| Qty. Containers per pallet: | 56 pcs. |
| Shipping dimensions mm: | 1300×1000×2150 h |

ORD. NO. F PL 8151 00 04 -single

| | |
|------------------|-------------------------------------------|
| Measurements: | 5P4PL-Z4 |
| Standard colour: | 01 grey 02 green 03 red 04 blue 05 yellow |

| | |
|---------------------------|-------------------|
| Weight gr.: | 3370 |
| External nominal dim. mm: | 520/450×450×300 h |
| Internal nominal dim. mm: | 433×430×277 h |

ORD. NO. FYL 8151 00 04 -pallet

| | |
|-----------------------------|------------------|
| Weight of pallet kg: | 154 |
| Qty. Containers per pallet: | 42 pcs. |
| Shipping dimensions mm: | 1400×1100×2100 h |



SOLID BOTTOM



SOLID BOTTOM



ORD. NO. F PL 8951 00 03 -single

| | |
|------------------|-------------------------------------------|
| Measurements: | 5PL-Z3 |
| Standard colour: | 01 grey 02 green 03 red 04 blue 05 yellow |

| | |
|---------------------------|-------------------|
| Weight gr.: | 4378 |
| External nominal dim. mm: | 700/630×450×300 h |
| Internal nominal dim. mm: | 618×428×276 h |

ORD. NO. FYL 8951 00 03 -pallet

| | |
|-----------------------------|------------------|
| Weight of pallet kg: | 135 |
| Qty. Containers per pallet: | 28 pcs. |
| Shipping dimensions mm: | 1450×1000×2100 h |

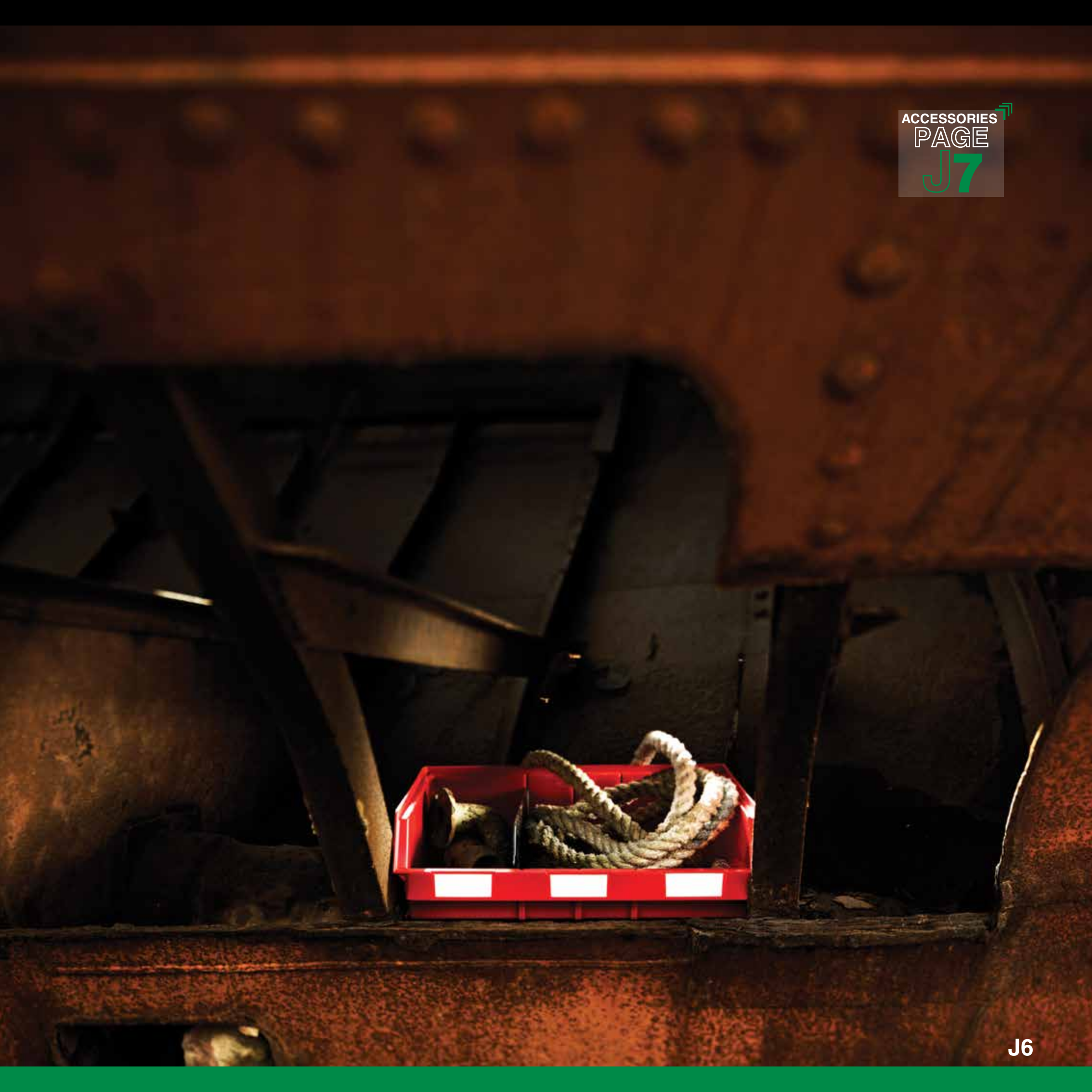

ACCESSORIES STORAGE CONTAINERS

ZEUS - COMPAT



TROUGHS

Made from **polypropylene**, the **troughs** can **divide** the container into **6 or 8 compartments** according to **requirements**.



| ORD. NO. | External dim. mm |
|------------------------|----------------------------------------------------------------|
| F PJ 2551 00 01 | 200×140×130 h |
| No. of troughs | 6 per ORD. NO. F PL 8151 00.. 8 per ORD. NO. F PL 8951 00.. |

| ORD. NO. | colour |
|-----------------|--------|
| F PJ 2551 00 01 | grey |
| F PJ 2551 00 02 | green |
| F PJ 2551 00 03 | red |
| F PJ 2551 00 04 | blue |
| F PJ 2551 00 05 | yellow |



troughs with 2/4 compartments

The **smaller containers** can be divided using polypropylene **troughs** with **2 or 4 compartments**. The troughs can also be used **separately** to **store** and **separate** small objects.



2 compartments



| ORD. NO. | External dim. mm |
|-------------------------|------------------|
| F PP 0551 00 01 | 150/120×90×35 h |
| No. of troughs | 2 |
| For containers ORD. NO. | F PM 1751 00.. |



| ORD. NO. | External dim. mm |
|-------------------------|------------------|
| F PP 1551 00 01 | 205/160×125×60 h |
| No. of troughs | 2 |
| For containers ORD. NO. | F PM 2551 00.. |

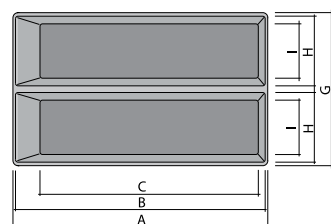
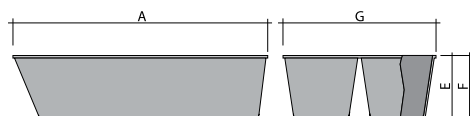

| troughs | A | B | B1 | C | C1 | E | F | G | H | I |
|------------------------|-----|-----|----|-----|----|----|----|-----|----|----|
| F PP 0551 00 01 | 148 | 140 | - | 115 | - | 32 | 33 | 87 | 40 | 30 |
| F PP 1551 00 01 | 201 | 190 | - | 155 | - | 57 | 58 | 125 | 55 | 40 |

The technical data contained in the above table is approximate. FAMI S.r.l. reserves the right to make any modifications it sees fit to improve the performance and appearance of products. The manufacturer is not liable for any printing errors.

4 compartments



| ORD. NO. | External dim. mm |
|-------------------------|------------------|
| F PP 1051 00 01 | 150/120×90×35 h |
| No. of troughs | 4 |
| For containers ORD. NO. | F PM 1751 00.. |



| ORD. NO. | External dim. mm |
|-------------------------|------------------|
| F PP 2051 00 01 | 205/160×125×60 h |
| No. of troughs | 4 |
| For containers ORD. NO. | F PM 2551 00.. |

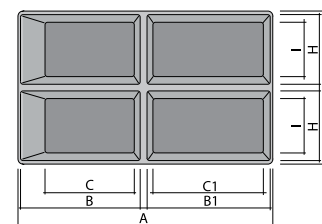
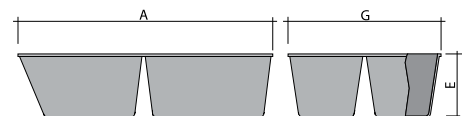

| troughs | A | B | B1 | C | C1 | E | F | G | H | I |
|------------------------|-----|----|----|----|----|----|----|-----|----|----|
| F PP 1051 00 01 | 148 | 66 | 66 | 44 | 58 | 32 | 33 | 87 | 37 | 30 |
| F PP 2051 00 01 | 201 | 93 | 93 | 56 | 76 | 57 | 58 | 125 | 57 | 40 |

The technical data contained in the above table is approximate. FAMI S.r.l. reserves the right to make any modifications it sees fit to improve the performance and appearance of products. The manufacturer is not liable for any printing errors.

FRONT TO BACK METAL DIVIDER

The container can be **sub-divided** using **metal front to back dividers** to fit into the existing **slots** of the container whilst some ranges allow **sub-division** with metal front to back dividers through **guide rails**.



front to back metal divider with pair of supports

| | |
|------------------------|-------------------------|
| ORD. NO. | For containers ORD. NO. |
| F ND 0211 01 99 | F PL 8151 00.. |

| | |
|------------------------|-------------------------|
| ORD. NO. | For containers ORD. NO. |
| F ND 0231 01 99 | F PL 8951 00.. |

supplementary front to back divider

| | |
|------------------------|-------------------------|
| ORD. NO. | For containers ORD. NO. |
| F ND 0211 00 99 | F PL 8151 00.. |

| | |
|------------------------|-------------------------|
| ORD. NO. | For containers ORD. NO. |
| F ND 0321 00 99 | F PL 8951 00.. |



front to back metal divider

| | |
|------------------------|-------------------------|
| ORD. NO. | For containers ORD. NO. |
| F ND 0110 00 99 | F PM 3351 00.. |

| | |
|------------------------|-------------------------|
| ORD. NO. | For containers ORD. NO. |
| F ND 0140 00 99 | F PM 4151 00.. |

| | |
|------------------------|-------------------------|
| ORD. NO. | For containers ORD. NO. |
| F ND 0150 00 99 | F PL 4951 00.. |

| | |
|------------------------|-------------------------|
| ORD. NO. | For containers ORD. NO. |
| F ND 0160 00 99 | F PM 5751 00.. |

| | |
|------------------------|-------------------------|
| ORD. NO. | For containers ORD. NO. |
| F ND 0180 00 99 | F PM 6551 00.. |

| | |
|------------------------|-------------------------|
| ORD. NO. | For containers ORD. NO. |
| F ND 0170 00 99 | F PM 7351 00.. |

sub-dividers

A pair of galvanized sheet metal **sub-dividers** may be **fitted perpendicularly** to the front to back **metal divider** in order to divide the container into **four or more compartments**.

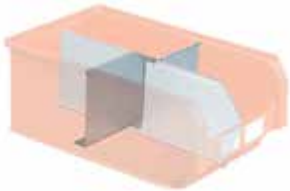

| | |
|------------------------|-------------------------|
| ORD. NO. | For containers ORD. NO. |
| F ND 1110 00 99 | F PM 6551 00.. |



99 HOT GALVANISED

front to back plastic divider

In addition to the metal dividers, front to back plastic dividers are also available and fit easily into the slots in the containers.

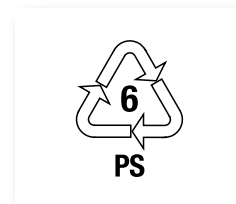
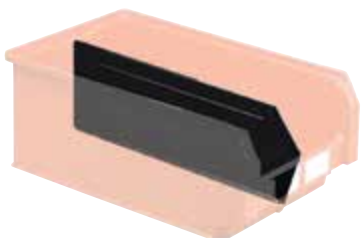

| | |
|------------------------|-------------------------|
| ORD. NO. | For containers ORD. NO. |
| F PZ 1071 00 07 | F PM 3351 00.. |

| | |
|------------------------|-------------------------|
| ORD. NO. | For containers ORD. NO. |
| F PZ 1571 00 07 | F PM 4151 00.. |

| | |
|------------------------|-------------------------|
| ORD. NO. | For containers ORD. NO. |
| F PZ 2071 00 07 | F PL 4951 00.. |

| | |
|------------------------|-------------------------|
| ORD. NO. | For containers ORD. NO. |
| F PZ 2571 00 07 | F PM 6551 00.. |

| | |
|------------------------|-------------------------|
| ORD. NO. | For containers ORD. NO. |
| F PZ 3071 00 07 | F PM 7351 00.. |

07 BLACK

INCLINED LABEL HOLDER

This **type** of label holder makes it easier to **read** the **labels** applied to containers located in the **lower** parts of shelving units, **trolleys** and **cabinets**. It can be fitted and removed with ease.

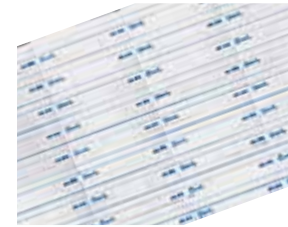

ORD. NO. F ND 2110 00 99

FOR containers
ORD. NO. F PM 3351 00.. - F PM 4151 00..
F PM 4251 00.. - F PM 6551 00..
F PM 6651 00.. - F PM 7351 00..
F PM 7451 00..



ORD. NO. F ND 2130 00 99

FOR containers
ORD. NO. F PL 8151 00.. - F PL 8951 00..

SPECIAL LABELS

Page Q1

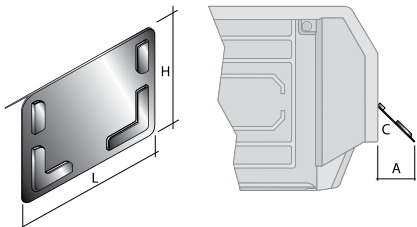

| inclined label holder ORD. NO. | L (mm) | H (mm) | A (mm) | C (grade) |
|-----------------------------------|-----------|-----------|-----------|--------------|
| F ND 2110 00 99 | 100 | 67 | 40*50** | 45° |
| F ND 2130 00 99 | 128 | 90 | 65 | 45° |

* ZEUS - ** COMPAT

The technical data contained in the above table is approximate. FAMI S.r.l. reserves the right to make any modifications it sees fit to improve the performance and appearance of products. The manufacturer is not liable for any printing errors.

labels

Proportional to the size of the **containers** to which they are applied.

| label sheet | For containers ORD. NO. | Size of label | No. of labels per sheet |
|-----------------|-------------------------------------------------------|---------------|-------------------------|
| F PL 9020 00 00 | F PL 0951 00 .. | 49x11 | 80 |
| F PL 9040 00 00 | F PM 1751 00 .. | 75x20 | 36 |
| F PL 9100 00 00 | F PM 2551 00 .. | 104x33 | 16 |
| F PL 9060 00 00 | F PM 3351 00 .. F PL 4951 00 .. F PM 5751 00 .. | 77x31 | 18 |
| F PL 9080 00 00 | F PM 4151 00 .. F PM 6551 00 .. F PM 7351 00 .. | 77x42 | 12 |
| F PL 9120 00 00 | F PL 8151 00 .. F PL 8951 00 .. | 127x39 | 10 |
| F PL 9160 00 00 | F PL 8151 00 .. F PL 8951 00 .. | 189x85 | 3 |

The technical data contained in the above table is approximate. FAMI S.r.l. reserves the right to make any modifications it sees fit to improve the performance and appearance of products. The manufacturer is not liable for any printing errors.

dust cover

Made from **transparent polystyrene**, the **dust cover** allows the product to be **identified** while **protecting** it from dust. It can be opened with a **slot and hinge** on the **front** of the container and, when **closed**, it increases the **load capacity** of the container itself.



ORD. NO. For containers
ORD. NO.
F PZ 5668 00 96 F PM 3351 00..

ORD. NO. For containers
ORD. NO.
F PZ 5368 00 96 F PM 4151 00..

ORD. NO. For containers
ORD. NO.
F PZ 6568 00 96 F PM 6551 00..

ORD. NO. For containers
ORD. NO.
F PZ 6268 00 96 F PM 7351 00..

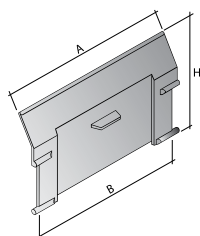

| dust cover ORD. NO. | A (mm) | B (mm) | H (mm) |
|------------------------|-----------|-----------|-----------|
| F PZ 5668 00 96 | 157 | 169 | 63 |
| F PZ 5368 00 96 | 153 | 166 | 93 |
| F PZ 6568 00 96 | 250 | 264 | 93 |
| F PZ 6268 00 96 | 250 | 262 | 135 |

The technical data contained in the above table is approximate. FAMI S.r.l. reserves the right to make any modifications it sees fit to improve the performance and appearance of products. The manufacturer is not liable for any printing errors.

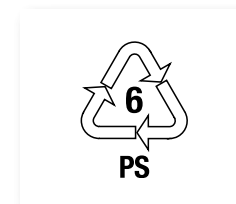

96 TRANSPARENT

J10

boxes series

MULTIBOX

page K3



stacking housings for

MULTIBOX boxes

page K9



K1



MULTIBOX SYSTEM



BOXES SERIES MULTIBOX

The **Multibox** series **F PK** boxes are produced in **10** different sizes and are available in **blue**. They are **manufactured** with top quality **polypropylene** that makes them **resistant** and **long-lasting**. They are available in widths of **120, 140, 160** and **240** mm and can be partitioned by **dividers** into various compartments. A **special** area on the **fronts** of the boxes and **dividers** allows **labels** to be applied if required. A practical **handle** that makes it **easy** to **lift** and carry the **boxes** by **hand** can be supplied on request.

HandLe



A special handle, supplied on request, makes it easy to lift and carry the Multibox series F PK boxes.

The special design of the Multibox Series F PK polypropylene boxes and their relative shelving units make for flexible and functional warehousing by keeping everything neat and tidy and within easy reach. Available in ten different sizes to satisfy all requirements, these boxes are oil resistant and can be partitioned with dividers making them especially suitable for stockists.

DiScOVER The WoRLd Of **muLtibOx** !

shelving system series **F ST**

steel workstations

cabinets for Multibox



Walls

Made from top quality polypropylene, the Multibox series F PK boxes feature shock resistant walls reinforced with special ribbing.



Dividers

Made from transparent polystyrene, the dividers allow the boxes to be separated into various compartments.

Transparent polystyrene dividers and labels available.



labels



They are provided with various sizes of label holders and relative labels depending on the sizes of the boxes to which they are attached.

MULTIBOX



04 BLUE

| boxes ORD. NO. | A | B | C | D | E | F | G | G1 | H | I | L |
|-----------------|-----|-----|-----|-----|----|-----|-----|-----|-----|-----|-----|
| F PK 0551 00 04 | 299 | 262 | 257 | 265 | 89 | 100 | 121 | 121 | 98 | 95 | 112 |
| F PK 1551 00 04 | 401 | 365 | 357 | 367 | 89 | 100 | 121 | 121 | 98 | 96 | 111 |
| F PK 3051 00 04 | 503 | 466 | 461 | 468 | 89 | 100 | 120 | 120 | 97 | 95 | 112 |
| F PK 1051 00 04 | 299 | 263 | 260 | 267 | 89 | 100 | 160 | 162 | 138 | 136 | 151 |
| F PK 2051 00 04 | 399 | 363 | 358 | 367 | 89 | 100 | 160 | 162 | 138 | 136 | 150 |
| F PK 3551 00 04 | 499 | 464 | 460 | 467 | 89 | 100 | 159 | 162 | 139 | 136 | 150 |
| F PK 4551 00 04 | 601 | 565 | 560 | 569 | 89 | 100 | 160 | 162 | 138 | 136 | 151 |
| F PK 2551 00 04 | 401 | 363 | 358 | 367 | 89 | 100 | 240 | 242 | 216 | 215 | 232 |
| F PK 4051 00 04 | 504 | 466 | 461 | 469 | 89 | 100 | 241 | 243 | 217 | 215 | 231 |
| F PK 2751 00 04 | 434 | 421 | 403 | 420 | 70 | 79 | 139 | 139 | 122 | 121 | 127 |

The technical data contained in the above table is approximate. FAMI S.r.l. reserves the right to make any modifications it sees fit to improve the performance and appearance of products. The manufacturer is not liable for any printing errors.



Detail of
SOLID
BOTTOM

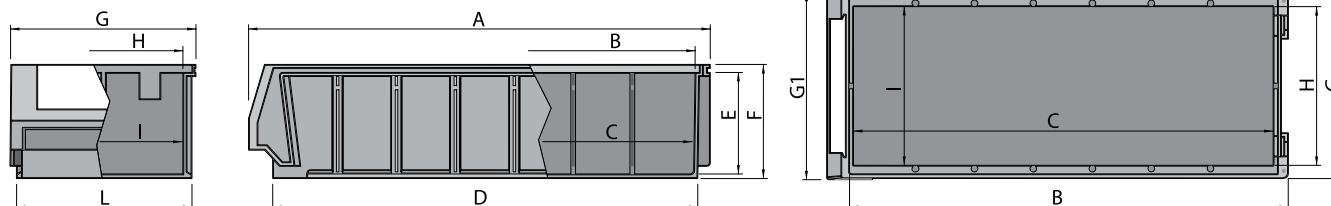

**ORD. NO. F PK 0551 00 04 -single**

| | |
|------------------|-----------|
| Measurements: | RK3012 |
| Standard colour: | 04 blue ■ |
| Batch of: | 32 pcs. |

| | |
|---------------------------|---------------|
| Weight gr.: | 348 |
| External nominal dim. mm: | 300×120×100 h |
| Internal nominal dim. mm: | 257×95×89 h |

ORD. NO. FYK 0551 00 04 -pallet

| | |
|-----------------------------|------------------|
| Weight of pallet kg: | 202 |
| Qty. Containers per pallet: | 512 pcs. |
| Shipping dimensions mm: | 1300×1000×1700 h |

SOLID BOTTOM**ORD. NO. F PK 1551 00 04 -single**

| | |
|------------------|-----------|
| Measurements: | RK4012 |
| Standard colour: | 04 blue ■ |
| Batch of: | 32 pcs. |

| | |
|---------------------------|---------------|
| Weight gr.: | 438 |
| External nominal dim. mm: | 400×120×100 h |
| Internal nominal dim. mm: | 357×96×89 h |

ORD. NO. FYK 1551 00 04 -pallet

| | |
|-----------------------------|------------------|
| Weight of pallet kg: | 192 |
| Qty. Containers per pallet: | 384 pcs. |
| Shipping dimensions mm: | 1300×1000×1700 h |

SOLID BOTTOM

ACCESSORIES
PAGE
K15

**ORD. NO. F PK 3051 00 04 -single**

| | |
|------------------|-----------|
| Measurements: | RK5012 |
| Standard colour: | 04 blue ■ |
| Batch of: | 32 pcs. |

| | |
|---------------------------|---------------|
| Weight gr.: | 528 |
| External nominal dim. mm: | 500×120×100 h |
| Internal nominal dim. mm: | 461×95×89 h |

ORD. NO. FYK 3051 00 04 -pallet

| | |
|-----------------------------|------------------|
| Weight of pallet kg: | 154 |
| Qty. Containers per pallet: | 256 pcs. |
| Shipping dimensions mm: | 1050×1000×1700 h |

SOLID BOTTOM**ORD. NO. F PK 1051 00 04 -single**

| | |
|------------------|-----------|
| Measurements: | RK3016 |
| Standard colour: | 04 blue ■ |
| Batch of: | 24 pcs. |

| | |
|---------------------------|---------------|
| Weight gr.: | 370 |
| External nominal dim. mm: | 300×160×100 h |
| Internal nominal dim. mm: | 260×136×89 h |

ORD. NO. FYK 1051 00 04 -pallet

| | |
|-----------------------------|------------------|
| Weight of pallet kg: | 166 |
| Qty. Containers per pallet: | 384 pcs. |
| Shipping dimensions mm: | 1300×1000×1700 h |

SOLID BOTTOM



SOLID BOTTOM



SOLID BOTTOM



SOLID BOTTOM



ORD. NO. F PK 2051 00 04 -single

Measurements: RK4016

Standard colour: 04 blue ■

Batch of: 24 pcs.

Weight gr.: 448

External nominal dim. mm: 400×160×100 h

Internal nominal dim. mm: 358×136×89 h

ORD. NO. FYK 2051 00 04 -pallet

Weight of pallet kg: 153

Qty. Containers per pallet: 288 pcs.

Shipping dimensions mm: 1300×1000×1700 h

ORD. NO. F PK 3551 00 04 -single

Measurements: RK5016

Standard colour: 04 blue ■

Batch of: 24 pcs.

Weight gr.: 540

External nominal dim. mm: 500×160×100 h

Internal nominal dim. mm: 460×136×89 h

ORD. NO. FYK 3551 00 04 -pallet

Weight of pallet kg: 123

Qty. Containers per pallet: 192 pcs.

Shipping dimensions mm: 1050×1000×1700 h

ORD. NO. F PK 4551 00 04 -single

Measurements: RK6016

Standard colour: 04 blue ■

Batch of: 24 pcs.

Weight gr.: 662

External nominal dim. mm: 600×160×100 h

Internal nominal dim. mm: 560×136×89 h

ORD. NO. FYK 4551 00 04 -pallet

Weight of pallet kg: 150

Qty. Containers per pallet: 192 pcs.

Shipping dimensions mm: 1300×1000×1700 h

ACCESSORIES
PAGE
K15



SOLID BOTTOM



SOLID BOTTOM



SOLID BOTTOM



ORD. NO. F PK 2551 00 04 -single

| | |
|------------------|-----------|
| Measurements: | RK4024 |
| Standard colour: | 04 blue ■ |
| Batch of: | 16 pcs. |

| | |
|---------------------------|---------------|
| Weight gr.: | 644 |
| External nominal dim. mm: | 400×240×100 h |
| Internal nominal dim. mm: | 358×215×89 h |

ORD. NO. FYK 2551 00 04 -pallet

| | |
|-----------------------------|------------------|
| Weight of pallet kg: | 148 |
| Qty. Containers per pallet: | 192 pcs. |
| Shipping dimensions mm: | 1300×1000×1700 h |

ORD. NO. F PK 4051 00 04 -single

| | |
|------------------|-----------|
| Measurements: | RK5024 |
| Standard colour: | 04 blue ■ |
| Batch of: | 16 pcs. |

| | |
|---------------------------|---------------|
| Weight gr.: | 766 |
| External nominal dim. mm: | 500×240×100 h |
| Internal nominal dim. mm: | 461×215×89 h |

ORD. NO. FYK 4051 00 04 -pallet

| | |
|-----------------------------|------------------|
| Weight of pallet kg: | 117 |
| Qty. Containers per pallet: | 128 pcs. |
| Shipping dimensions mm: | 1050×1000×1700 h |

ORD. NO. F PK 2751 00 04 -single

| | |
|------------------|-----------|
| Measurements: | RK218 |
| Standard colour: | 04 blue ■ |
| Batch of: | 30 pcs. |

| | |
|---------------------------|--------------|
| Weight gr.: | 324 |
| External nominal dim. mm: | 435×140×80 h |
| Internal nominal dim. mm: | 403×121×70 h |

ORD. NO. FYK 2751 00 04 -pallet

| | |
|-----------------------------|------------------|
| Weight of pallet kg: | 226 |
| Qty. Containers per pallet: | 600 pcs. |
| Shipping dimensions mm: | 1400×1150×1960 h |

STACKING HOUSINGS FOR
MULTIBOX BOXES





The Multibox series F PK boxes fit perfectly into sheet steel stacking containers that have been designed to be modular in order to satisfy numerous operative requirements. The upper part of each stacking container is fitted with two tabs for fixing the container mounted above it while in the lower part a base plinth can be fitted. Stacking containers with the same depth or with decreasing depths can be fitted on top of each other. The shelves are fixed and fitted with slots for inserting the Multibox box guides. Each shelf can contain four 120 mm, three 160 mm and two 240 mm wide Multibox boxes.

GuidES

Made from galvanized sheet steel, the guides are fitted into the relative slots in the stacking containers and allow the Multibox boxes to slide freely.



SaFeTy GUARDS



The shelving units can be mounted on vans. In this case, special galvanized steel safety guards should be used to prevent the boxes from falling out.

GalvanIzED STEEL saFeTy GUARD



The galvanised steel safety guard prevents the boxes from accidentally falling out of the stacking housings.



Stacking shelves

The Multibox stacking containers can be mounted one on top of the other and can satisfy a wide range of user requirements. Containers with the same depth or with decreasing depths can be stacked so as to fully exploit all available space.



Stacking housings with tabs for fixing the containers mounted one on the top of the other. The stacking housing must be fitted to the wall with 2 Ø 8 mm screws.

FITTING THE BASE PLINTh





01 grey ral 7000
electrophoresis painted

500 × 300 × 545

without multibox

Including Guide RAILS and SaFeTy GUARDS for boxes



| ORD. NO. | DIM. mm |
|-----------------|-------------|
| F PK 9030 00 01 | 500×300×545 |



| ORD. NO. | DIM. mm |
|----------------------------------|-------------|
| F PK 9030 01 01 | 500×300×545 |
| 16 pcs. ORD. NO. F PK 0551 00 04 | |



| ORD. NO. | DIM. mm |
|----------------------------------|-------------|
| F PK 9030 02 01 | 500×300×545 |
| 12 pcs. ORD. NO. F PK 1051 00 04 | |



| ORD. NO. | DIM. mm |
|---------------------------------|-------------|
| F PK 9030 03 01 | 500×300×545 |
| 8 pcs. ORD. NO. F PK 0551 00 04 | |
| 6 pcs. ORD. NO. F PK 1051 00 04 | |

500 × 400 × 545

without multibox

Including Guide RAILS and SaFeTy GUARDS for boxes



| ORD. NO. | DIM. mm |
|-----------------|-------------|
| F PK 9040 00 01 | 500×400×545 |



| ORD. NO. | DIM. mm |
|----------------------------------|-------------|
| F PK 9040 01 01 | 500×400×545 |
| 16 pcs. ORD. NO. F PK 1551 00 04 | |



| ORD. NO. | DIM. mm |
|----------------------------------|-------------|
| F PK 9040 02 01 | 500×400×545 |
| 12 pcs. ORD. NO. F PK 2051 00 04 | |



| ORD. NO. | DIM. mm |
|---------------------------------|-------------|
| F PK 9040 03 01 | 500×400×545 |
| 8 pcs. ORD. NO. F PK 1551 00 04 | |
| 6 pcs. ORD. NO. F PK 2051 00 04 | |



| ORD. NO. | DIM. mm |
|---------------------------------|-------------|
| F PK 9040 04 01 | 500×400×545 |
| 8 pcs. ORD. NO. F PK 2551 00 04 | |



| ORD. NO. | DIM. mm |
|---------------------------------|-------------|
| F PK 9040 05 01 | 500×400×545 |
| 8 pcs. ORD. NO. F PK 1551 00 04 | |
| 4 pcs. ORD. NO. F PK 2551 00 04 | |



| ORD. NO. | DIM. mm |
|---------------------------------|-------------|
| F PK 9040 06 01 | 500×400×545 |
| 6 pcs. ORD. NO. F PK 2051 00 04 | |
| 4 pcs. ORD. NO. F PK 2551 00 04 | |



| ORD. NO. | DIM. mm |
|---------------------------------|-------------|
| F PK 9040 07 01 | 500×400×545 |
| 4 pcs. ORD. NO. F PK 1551 00 04 | |
| 6 pcs. ORD. NO. F PK 2051 00 04 | |
| 2 pcs. ORD. NO. F PK 2551 00 04 | |

500x500x545

without multibox

Including Guide RAILS and saFeTy GUARDS for boxes



ORD. NO. DIM. mm
F PK 9050 00 01 500x500x545



ORD. NO. DIM. mm
F PK 9050 01 01 500x500x545
 16 pcs. ORD. NO. F PK 3051 00 04



ORD. NO. DIM. mm
F PK 9050 02 01 500x500x545
 12 pcs. ORD. NO. F PK 3551 00 04



ORD. NO. DIM. mm
F PK 9050 03 01 500x500x545
 8 pcs. ORD. NO. F PK 3051 00 04
 6 pcs. ORD. NO. F PK 3551 00 04



ORD. NO. DIM. mm
F PK 9050 04 01 500x500x545
 8 pcs. ORD. NO. F PK 4051 00 04



ORD. NO. DIM. mm
F PK 9050 05 01 500x500x545
 8 pcs. ORD. NO. F PK 3051 00 04
 4 pcs. ORD. NO. F PK 4051 00 04



ORD. NO. DIM. mm
F PK 9050 06 01 500x500x545
 6 pcs. ORD. NO. F PK 3551 00 04
 4 pcs. ORD. NO. F PK 4051 00 04



ORD. NO. DIM. mm
F PK 9050 07 01 500x500x545
 4 pcs. ORD. NO. F PK 3051 00 04
 6 pcs. ORD. NO. F PK 3551 00 04
 2 pcs. ORD. NO. F PK 4051 00 04

500x600x545

without multibox

Including Guide RAILS and saFeTy GUARDS for boxes



ORD. NO. DIM. mm
F PK 9060 00 01 500x600x545



ORD. NO. DIM. mm
F PK 9060 02 01 500x600x545
 12 pcs. ORD. NO. F PK 4551 00 04



ACCESSORIES
 PAGE
K13

ACCESSORIES FOR STACKING HOUSINGS



BASE PLINTHS

The **stacking containers** can be **raised** and **isolated** from the floor thanks to the **painted sheet steel base plinths**. The stacking containers are simply **fitted on top of them**.



| ORD. NO. | DIM. mm |
|-------------------------------|------------------------|
| F PK 9135 00 01 | 485×275×90 h |
| For stacking housing ORD. NO. | F PK 9030 00 01 |

| ORD. NO. | DIM. mm |
|-------------------------------|------------------------|
| F PK 9145 00 01 | 485×375×90 h |
| For stacking housing ORD. NO. | F PK 9040 00 01 |

| ORD. NO. | DIM. mm |
|-------------------------------|------------------------|
| F PK 9155 00 01 | 485×475×90 h |
| For stacking housing ORD. NO. | F PK 9050 00 01 |

| ORD. NO. | DIM. mm |
|-------------------------------|------------------------|
| F PK 9165 00 01 | 485×575×90 h |
| For stacking housing ORD. NO. | F PK 9060 00 01 |

OT GREY

safety guards for stacking housing

Made from **galvanized steel**, the safety guards prevent the **Multibox** series **F PK** boxes from accidentally **falling out** of the **stacking container**. This **practical** and **simple blocking** system is useful when stacking containers are mounted on cars or **vans** which may **skid** or **brake sharply**.



ORD. NO. **F PK 9360 00 99**

FOR stacking
housings ORD. NO.

F PK 9030 00 01 - F PK 9040 00 01 - F PK 9050 00 01 - F PK 9060 00 01

99 HOT GALVANISED

guides for stacking housings

The **galvanized sheet steel guides** for the **Multibox** boxes are fitted from **front to back** into the relative **slots** on the fixed **shelves** of the **stacking container**.



ORD. NO. **F ST 9830 00 99**

FOR stacking housing
ORD. NO. **F PK 9030 00 01**



ORD. NO. **F ST 9840 00 99**

FOR stacking housing
ORD. NO. **F PK 9040 00 01**



ORD. NO. **F ST 9850 00 99**

FOR stacking housing
ORD. NO. **F PK 9050 00 01**



ORD. NO. **F ST 9860 00 99**

FOR stacking housing
ORD. NO. **F PK 9060 00 01**



99 HOT GALVANISED

ACCESSORIES MULTIBOX



K15

HANDLES



The **Multibox** series **F PK** boxes can be supplied with a **handle** that makes it **easy** to **lift** and carry them. This **handle** must be **ordered** separately.



| ORD. NO. | DIM. mm |
|-----------------|---------|
| F PK 6051 00 04 | 70x90 h |

For ORD. NO.

F PK 0551 00 04 - F PK 1551 00 04 - F PK 3051 00 04

| ORD. NO. | DIM. mm |
|-----------------|----------|
| F PK 6651 00 04 | 110x90 h |

For ORD. NO.

F PK 2551 00 04 - F PK 4051 00 04

| ORD. NO. | DIM. mm |
|-----------------|----------|
| F PK 6351 00 04 | 120x80 h |

For ORD. NO.

F PK 1051 00 04 - F PK 2051 00 04 - F PK 3551 00 04 - F PK 4551 00 04



04 BLUE

safety guards

Made from **galvanized sheet steel**, the **safety guards** are supplied standard and **prevent** the **boxes** from **falling out** by **accident**.



| ORD. NO. | Ø (mm) |
|-----------------|--------|
| F PK 9410 00 99 | 3 |

For ORD. NO.

F PK 0551 00 04 - F PK 1551 00 04 - F PK 3051 00 04

| ORD. NO. | Ø (mm) |
|-----------------|--------|
| F PK 9420 00 99 | 3 |

For ORD. NO.

F PK 1051 00 04 - F PK 2051 00 04 - F PK 3551 00 04 - F PK 4551 00 04 - F PK 2551 00 04 - F PK 4051 00 04



99 HOT GALVANISED

labels

Both the **boxes** and the **dividers** have been **designed** and produced to allow various **sizes** of **labels**, to be applied if **required**.

| label sheet | dim. label mm | no. labels per sheet |
|-----------------|---------------|----------------------|
| F PK 9540 00 00 | 81x42 | 12 |

FOR Boxes
ORD. NO.

F PK 0551 00 04 - F PK 1551 00 04 - F PK 3051 00 04

| label sheet | dim. label mm | no. labels per sheet |
|-----------------|---------------|----------------------|
| F PK 9580 00 00 | 121x44 | 8 |

FOR Boxes
ORD. NO.

F PK 1051 00 04 - F PK 2051 00 04 - F PK 3551 00 04
F PK 4551 00 04 - F PK 2751 00 04

| label sheet | dim. label mm | no. labels per sheet |
|-----------------|---------------|----------------------|
| F PK 9600 00 00 | 200x43 | 6 |

FOR Boxes
ORD. NO.

F PK 2551 00 04 - F PK 4051 00 04



Labels and dividers must be ordered separately

FRONT TO BACK DIVIDERS



Made from **galvanized sheet steel**, they are fitted into the relative **slots** and allow the **Multibox** boxes to be **divided** into two **compartments**.

| ORD. NO. | DIM. mm |
|------------------------|----------|
| F PK 9230 00 99 | 268×88 h |

FOR Boxes
ORD. NO. F PK 0551 00 04
F PK 1051 00 04

| ORD. NO. | DIM. mm |
|------------------------|----------|
| F PK 9240 00 99 | 368×88 h |

FOR Boxes
ORD. NO. F PK 1551 00 04
F PK 2051 00 04
F PK 2551 00 04

| ORD. NO. | DIM. mm |
|------------------------|----------|
| F PK 9250 00 99 | 468×88 h |

FOR Boxes
ORD. NO. F PK 3051 00 04
F PK 3551 00 04
F PK 4051 00 04

| ORD. NO. | DIM. mm |
|------------------------|----------|
| F PK 9260 00 99 | 568×88 h |

FOR Boxes
ORD. NO. F PK 4551 00 04

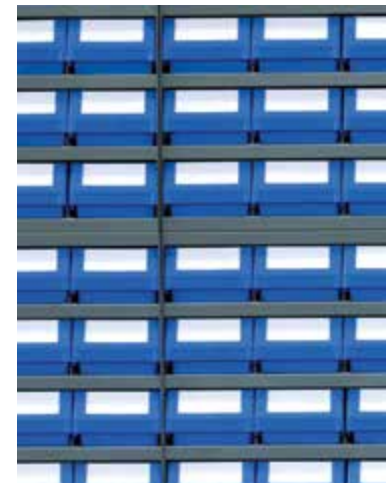

transversal dividers

The transparent polystyrene **sideways** dividers are supplied with **label holders** and allow the **Multibox** boxes to be **divided** into from 2 to 11 **compartments** depending on the **model**.



| ORD. NO. | DIM. mm |
|------------------------|----------|
| F PK 7068 00 96 | 100×90 h |

FOR Boxes
ORD. NO. F PK 0551 00 04
F PK 1551 00 04
F PK 3051 00 04



| ORD. NO. | DIM. mm |
|------------------------|----------|
| F PK 7368 00 96 | 145×90 h |

FOR Boxes
ORD. NO. F PK 1051 00 04
F PK 2051 00 04
F PK 3551 00 04
F PK 4551 00 04

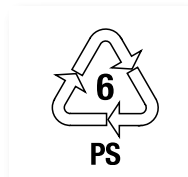

| ORD. NO. | DIM. mm |
|------------------------|----------|
| F PK 7668 00 96 | 225×90 h |

FOR Boxes
ORD. NO. F PK 2551 00 04
F PK 4051 00 04



| ORD. NO. | DIM. mm |
|------------------------|----------|
| F PK 7268 00 96 | 137×75 h |

FOR Boxes
ORD. NO. F PK 2751 00 04

Labels for dividers

| label sheet | dim. label mm | no. labels per sheet |
|-----------------|---------------|----------------------|
| F PK 9520 00 00 | 80x24 | 24 |

| label sheet | dim. label mm | no. labels per sheet |
|-----------------|---------------|----------------------|
| F PK 9560 00 00 | 121x24 | 16 |

| label sheet | dim. label mm | no. labels per sheet |
|-----------------|---------------|----------------------|
| F PK 9560 00 00 | 121x24 | 16 |

| label sheet | dim. label mm | no. labels per sheet |
|-----------------|---------------|----------------------|
| F PK 9520 00 00 | 80x24 | 24 |

for **Partition** No. F PK 7068 00 96

for **Partition** No. F PK 7368 00 96

for **Partition** No. F PK 7668 00 96

for **Partition** No. F PK 7268 00 96





Caron
FLUID CONNECTORS

R&D

KANBAN

CODICE

ARBGG06

DESCRIZIONE

RONDELLA BONDED GAS 3/8" K*

CARTELLINO



466

QUANTITA'

1500

6

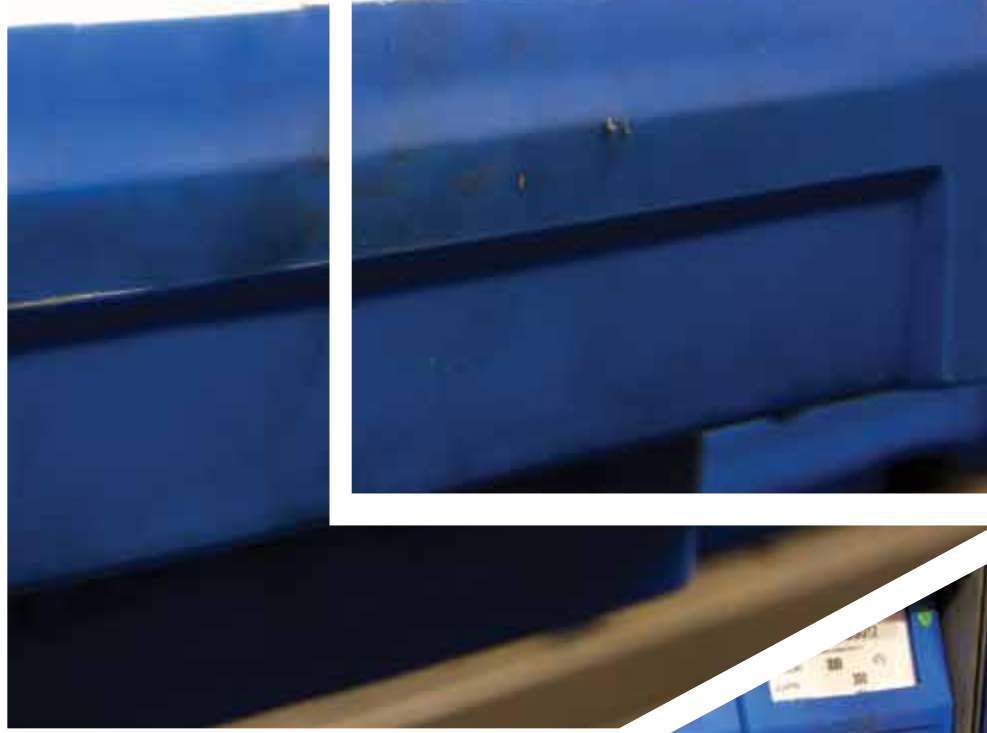

SINGLE CONTAINERS

page
L5



page
L5

BENCH DISPENSER

WALL SHELVING

page
L6



page
L9

SHELVING WITH BASE

ROTARY TOWER

page
L11



page
L13

VERTICAL SYSTEM

The Practibox containers comprise a grey ABS structure and compartments in transparent polystyrene with high mechanical resistance. Available in different depths and sizes, the Practibox containers are all 600 mm wide.

PRACTIBOX SYSTEM



TOP BOX CASE

page
L19



CONTAINERS SERIES
PRACTIBOX



The **FAMI Practibox containers** offer the most **practical** and **rational** solutions for **storing** numerous types of articles (**small items**, spare parts, **electrical material**, etc.). They can be used in **shops**, workshops, **laboratories**, factories, at **home** and for **hobbies**.



It is not recommended to use solvents to clean the compartments



ComPaRtmenTS

The compartments, made from transparent polystyrene with high mechanical resistance, are mounted in the relative ABS containers designed to be fitted to Practibox shelving systems and trolleys or fixed to the wall with brackets.



stackING

Available in various depths and heights, the Practibox containers are all 600 mm wide. Thanks to this feature containers with the same depth or decreasing depths can be mounted one on top of the other in order to create numerous combinations.



FRontAL OPENING



With easy-to-open compartments, the Practibox containers satisfy a wide range of customer requirements.



ORGANiSAtion

Everything is neatly separated, near to hand and easy to see.

ACCESSORIES 
PAGE
L21

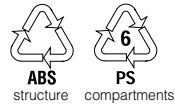

| ORD. NO. | size | width | mm 600 |
|-----------------|------|--------|--------|
| F PG 1071 01 01 | 890 | depth | mm 69 |
| | | height | mm 77 |

Container with 9 compartments
Batch of 2 pcs.

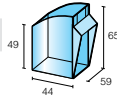

| ORD. NO. | size | width | mm 600 |
|-----------------|------|--------|--------|
| F PG 1571 01 01 | 860 | depth | mm 98 |
| | | height | mm 112 |

Container with 6 compartments
Batch of 2 pcs.

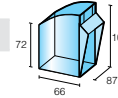

| ORD. NO. | size | width | mm 600 |
|-----------------|------|--------|--------|
| F PG 2071 01 01 | 850 | depth | mm 141 |
| | | height | mm 164 |

Container with 5 compartments

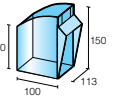

| ORD. NO. | size | width | mm 600 |
|-----------------|------|--------|--------|
| F PG 2571 01 01 | 840 | depth | mm 174 |
| | | height | mm 206 |

Container with 4 compartments

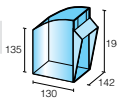

| ORD. NO. | size | width | mm 600 |
|-----------------|------|--------|--------|
| F PG 3071 01 01 | 830 | depth | mm 209 |
| | | height | mm 240 |

Container with 3 compartments

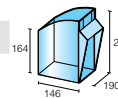

| ORD. NO. | size | width | mm 600 |
|-----------------|------|--------|--------|
| F PG 3571 01 01 | 820 | depth | mm 311 |
| | | height | mm 353 |

Container with 2 compartments

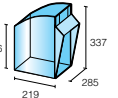

BENCH DISPENSER

Practical support for holding Practibox containers ideal for placing on the work bench they offer the operator a handy little warehouse. Realized in sheet metal, and supplied standard in colour RAL 7000.



| ORD. NO. | width | mm 610 |
|-----------------|--------|--------|
| F PG 0320 00 01 | depth | mm 150 |
| | height | mm 500 |

Realized in steel



| ORD. NO. | width | mm 610 |
|-----------------|--------|----------|
| F PG 0320 01 01 | depth | mm 189,5 |
| | height | mm 500 |

Including practibox containers

INCLUDING
practibox containers
ORD. NO.

- 1 Ord. No. F PG 1571 01 01
- 1 Ord. No. F PG 2071 01 01
- 1 Ord. No. F PG 2571 01 01

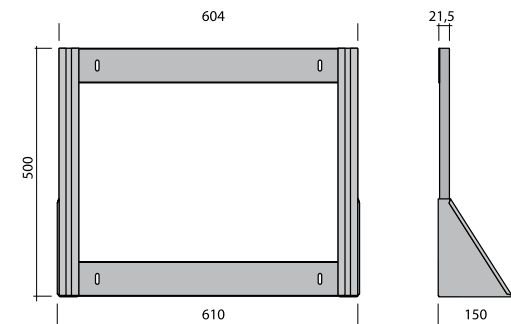

ORD. NO. F PG 0320 00 01 - measurements in mm

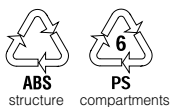

WALL SHELVING

SYSTEM TRANSPARENT
OF GREY

Made from painted sheet steel, the shelving fully exploits wall space and offers quick and practical storage. Available in heights of 300, 500, 650, 1000, 1500, 1750 and 1950 mm, they are supplied in standard grey RAL 7000. Expansion grips are used to mount the shelving to the wall.

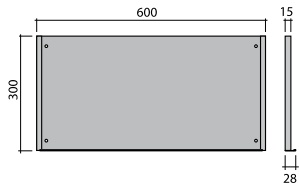
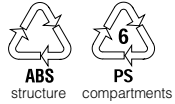

Ord. no. F PG 0410 00 01
measurements in mm



| ORD. NO. | Dim. mm |
|-------------------------------|--------------|
| F PG 0410 00 01 | 600x28x300 h |
| Made from painted sheet steel | |



| ORD. NO. | Dim. mm |
|--------------------------------------|--------------|
| F PG 0410 01 01 | 600x78x308 h |
| Including 4 Ord. no. F PG 1071 01 01 | |



| ORD. NO. | Dim. mm |
|--------------------------------------------------------------------|---------------|
| F PG 0410 02 01 | 600x107x300 h |
| Including 1 Ord. no. F PG 1071 01 01 2 Ord. no. F PG 1571 01 01 | |



| ORD. NO. | Dim. mm |
|--------------------------------------|---------------|
| F PG 0410 03 01 | 600x150x328 h |
| Including 2 Ord. no. F PG 2071 01 01 | |

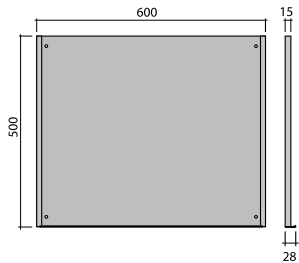

Ord. no. F PG 0420 00 01
measurements in mm



| ORD. NO. | Dim. mm |
|-------------------------------|--------------|
| F PG 0420 00 01 | 600x28x500 h |
| Made from painted sheet steel | |



| ORD. NO. | Dim. mm |
|--------------------------------------|--------------|
| F PG 0420 01 01 | 600x78x500 h |
| Including 6 Ord. no. F PG 1071 01 01 | |



| ORD. NO. | Dim. mm |
|--------------------------------------------------------------------|---------------|
| F PG 0420 02 01 | 600x107x500 h |
| Including 2 Ord. no. F PG 1071 01 01 3 Ord. no. F PG 1571 01 01 | |



| ORD. NO. | Dim. mm |
|--------------------------------------------------------------------------------------------------|---------------|
| F PG 0420 03 01 | 600x183x500 h |
| Including 1 Ord. no. F PG 1571 01 01 1 Ord. no. F PG 2071 01 01 1 Ord. no. F PG 2571 01 01 | |

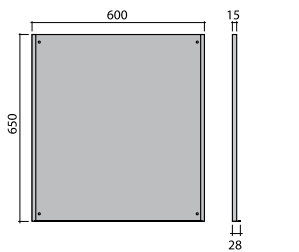

Ord. no. F PG 0430 00 01
measurements in mm



| ORD. NO. | Dim. mm |
|-------------------------------|--------------|
| F PG 0430 00 01 | 600x28x650 h |
| Made from painted sheet steel | |



| ORD. NO. | Dim. mm |
|--------------------------------------------------------------------|---------------|
| F PG 0430 01 01 | 600x150x664 h |
| Including 3 Ord. no. F PG 1571 01 01 2 Ord. no. F PG 2071 01 01 | |



| ORD. NO. | Dim. mm |
|--------------------------------------------------------------------|---------------|
| F PG 0430 02 01 | 600x107x650 h |
| Including 1 Ord. no. F PG 1071 01 01 5 Ord. no. F PG 1571 01 01 | |



| ORD. NO. | Dim. mm |
|--------------------------------------|--------------|
| F PG 0430 03 01 | 600x78x650 h |
| Including 8 Ord. no. F PG 1071 01 01 | |

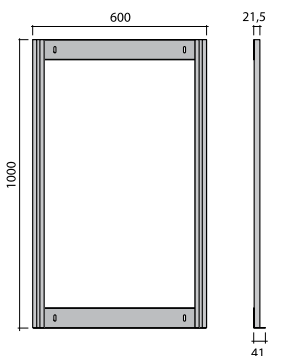

Ord. no. F PG 0530 00 01
measurements in mm



| ORD. NO. | Dim. mm |
|-------------------------------|---------------|
| F PG 0530 00 01 | 600x41x1000 h |
| Made from painted sheet steel | |



| ORD. NO. | Dim. mm |
|--------------------------------------|----------------|
| F PG 0530 02 01 | 600x113x1008 h |
| Including 9 Ord. no. F PG 1571 01 01 | |



| ORD. NO. | Dim. mm |
|--------------------------------------------------------------------------------------------------------------------------------|----------------|
| F PG 0530 03 01 | 600x224x1000 h |
| Including 2 Ord. no. F PG 1571 01 01 2 Ord. no. F PG 2071 01 01 1 Ord. no. F PG 2571 01 01 1 Ord. no. F PG 3071 01 01 | |



| ORD. NO. | Dim. mm |
|--------------------------------------------------------------------|----------------|
| F PG 0530 04 01 | 600x113x1022 h |
| Including 6 Ord. no. F PG 1071 01 01 5 Ord. no. F PG 1571 01 01 | |

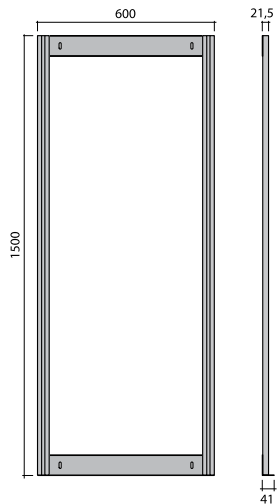
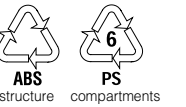

Ord. no. F PG 0540 00 01
measurements in mm



| ORD. NO. | Dim. mm |
|-------------------------------|---------------|
| F PG 0540 00 01 | 600×41×1500 h |
| Made from painted sheet steel | |



| ORD. NO. | Dim. mm |
|--------------------------------------------------------------------|----------------|
| F PG 0540 01 01 | 600×113×1500 h |
| Including 9 Ord. no. F PG 1071 01 01 7 Ord. no. F PG 1571 01 01 | |



| ORD. NO. | Dim. mm |
|---------------------------------------|----------------|
| F PG 0540 02 01 | 600×113×1568 h |
| Including 14 Ord. no. F PG 1571 01 01 | |



| ORD. NO. | Dim. mm |
|--------------------------------------------------------------------------------------------------------------------------------------------------------------|----------------|
| F PG 0540 03 01 | 600×224×1540 h |
| Including 2 Ord. no. F PG 1071 01 01 4 Ord. no. F PG 1571 01 01 3 Ord. no. F PG 2071 01 01 1 Ord. no. F PG 2571 01 01 1 Ord. no. F PG 3071 01 01 | |

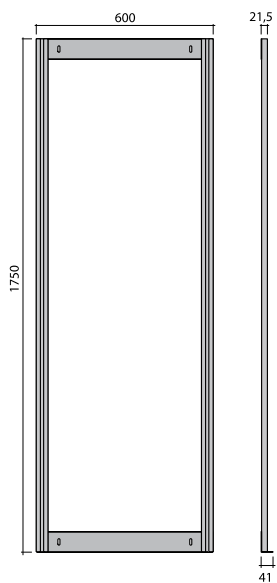

Ord. no. F PG 0550 00 01
measurements in mm



| ORD. NO. | Dim. mm |
|-------------------------------|---------------|
| F PG 0550 00 01 | 600×41×1750 h |
| Made from painted sheet steel | |



| ORD. NO. | Dim. mm |
|---------------------------------------------------------------------|----------------|
| F PG 0550 01 01 | 600×113×1750 h |
| Including 8 Ord. no. F PG 1071 01 01 10 Ord. no. F PG 1571 01 01 | |



| ORD. NO. | Dim. mm |
|---------------------------------------------------------------------|----------------|
| F PG 0550 02 01 | 600×113×1757 h |
| Including 1 Ord. no. F PG 1071 01 01 15 Ord. no. F PG 1571 01 01 | |



| ORD. NO. | Dim. mm |
|--------------------------------------------------------------------------------------------------------------------------------------------------------------|----------------|
| F PG 0550 03 01 | 600×224×1750 h |
| Including 1 Ord. no. F PG 1071 01 01 6 Ord. no. F PG 1571 01 01 2 Ord. no. F PG 2071 01 01 2 Ord. no. F PG 2571 01 01 1 Ord. no. F PG 3071 01 01 | |

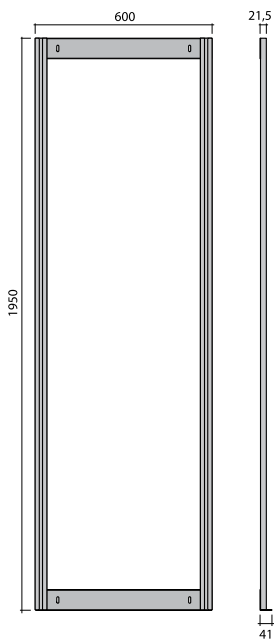

Ord. no. F PG 0560 00 01
measurements in mm



| ORD. NO. | Dim. mm |
|-------------------------------|---------------|
| F PG 0560 00 01 | 600×41×1950 h |
| Made from painted sheet steel | |



| ORD. NO. | Dim. mm |
|------------------------|-----------------|
| F PG 0560 01 01 | 600×113×1960 h |
| Including 8 Ord. no. | F PG 1071 01 01 |
| 12 Ord. no. | F PG 1571 01 01 |



| ORD. NO. | Dim. mm |
|------------------------|-----------------|
| F PG 0560 02 01 | 600×156×1950 h |
| Including 3 Ord. no. | F PG 1071 01 01 |
| 8 Ord. no. | F PG 1571 01 01 |
| 5 Ord. no. | F PG 2071 01 01 |



| ORD. NO. | Dim. mm |
|------------------------|-----------------|
| F PG 0560 03 01 | 600×326×1989 h |
| Including 6 Ord. no. | F PG 2071 01 01 |
| 2 Ord. no. | F PG 2571 01 01 |
| 1 Ord. no. | F PG 3071 01 01 |
| 1 Ord. no. | F PG 3571 01 01 |



Ord. no. F PG 0610 00 01
width mm 600
depth mm 300
height mm 100
complete kit of mounting screws

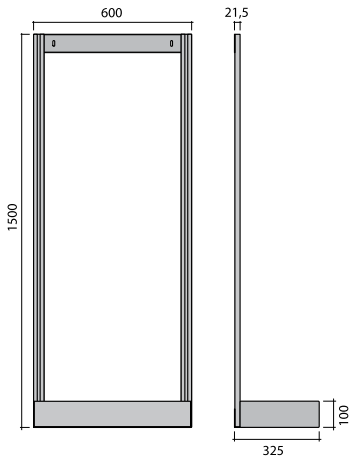
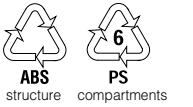

Ord. no. F PG 0640 00 01
measurements in mm

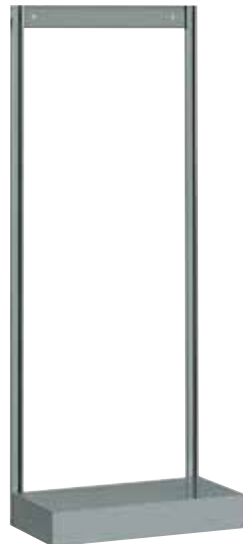

| ORD. NO. | Dim. mm |
|-------------------------------|----------------|
| F PG 0640 00 01 | 600x325x1500 h |
| stacking height | 1400 mm |
| Made from painted sheet steel | |



| ORD. NO. | Dim. mm |
|------------------------|-----------------|
| F PG 0640 01 01 | 600x325x1500 h |
| Including 8 Ord. no. | F PG 1071 01 01 |
| 7 Ord. no. | F PG 1571 01 01 |



| ORD. NO. | Dim. mm |
|------------------------|-----------------|
| F PG 0640 02 01 | 600x325x1556 h |
| Including 13 Ord. no. | F PG 1571 01 01 |



| ORD. NO. | Dim. mm |
|------------------------|-----------------|
| F PG 0640 03 01 | 600x325x1528 h |
| Including 2 Ord. no. | F PG 1071 01 01 |
| 3 Ord. no. | F PG 1571 01 01 |
| 3 Ord. no. | F PG 2071 01 01 |
| 1 Ord. no. | F PG 2571 01 01 |
| 1 Ord. no. | F PG 3071 01 01 |

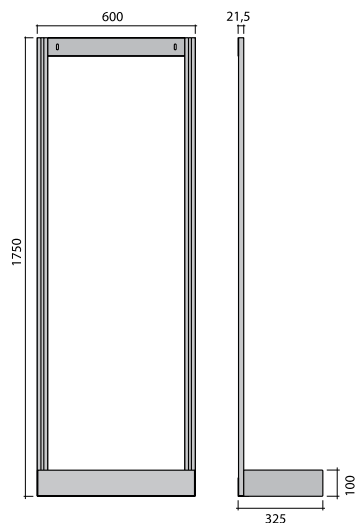

Ord. no. F PG 0650 00 01
measurements in mm



| ORD. NO. | Dim. mm |
|-------------------------------|----------------|
| F PG 0650 00 01 | 600x325x1750 h |
| stacking height | 1650 mm |
| Made from painted sheet steel | |



| ORD. NO. | Dim. mm |
|------------------------|-----------------|
| F PG 0650 02 01 | 600x325x1786 h |
| Including 6 Ord. no. | F PG 1071 01 01 |
| 8 Ord. no. | F PG 1571 01 01 |
| 2 Ord. no. | F PG 2071 01 01 |



| ORD. NO. | Dim. mm |
|------------------------|-----------------|
| F PG 0650 03 01 | 600x325x1750 h |
| Including 2 Ord. no. | F PG 1071 01 01 |
| 3 Ord. no. | F PG 1571 01 01 |
| 3 Ord. no. | F PG 2071 01 01 |
| 2 Ord. no. | F PG 2571 01 01 |
| 1 Ord. no. | F PG 3071 01 01 |



| ORD. NO. | Dim. mm |
|------------------------|-----------------|
| F PG 0650 04 01 | 600x325x1770 h |
| Including 5 Ord. no. | F PG 1571 01 01 |
| 3 Ord. no. | F PG 2071 01 01 |
| 3 Ord. no. | F PG 2571 01 01 |



As an alternative to wall-mounting, the frame is fixed to a practical base made from shaped sheet metal painted in standard grey RAL 7000.

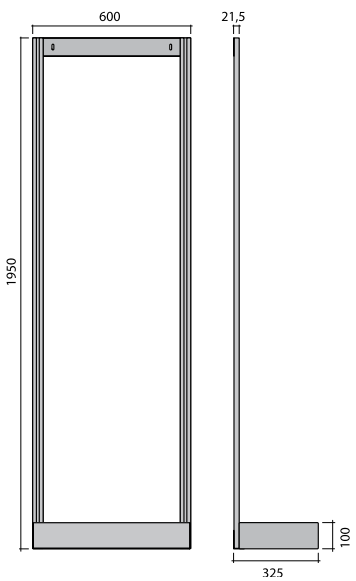

Ord. no. F PG 0660 00 01
measurements in mm



| ORD. NO. | Dim. mm |
|-------------------------------|----------------|
| F PG 0660 00 01 | 600×325×1950 h |
| stacking height | 1850 mm |
| Made from painted sheet steel | |



| ORD. NO. | Dim. mm |
|------------------------|-----------------|
| F PG 0660 01 01 | 600×325×1950 h |
| Including 6 Ord. no. | F PG 1071 01 01 |
| 9 Ord. no. | F PG 1571 01 01 |
| 1 Ord. no. | F PG 2071 01 01 |
| 1 Ord. no. | F PG 2571 01 01 |



| ORD. NO. | Dim. mm |
|------------------------|-----------------|
| F PG 0660 02 01 | 600×325×1950 h |
| Including 2 Ord. no. | F PG 1071 01 01 |
| 3 Ord. no. | F PG 1571 01 01 |
| 3 Ord. no. | F PG 2071 01 01 |
| 3 Ord. no. | F PG 2571 01 01 |
| 1 Ord. no. | F PG 3071 01 01 |



| ORD. NO. | Dim. mm |
|------------------------|-----------------|
| F PG 0660 03 01 | 600×325×1976 h |
| Including 5 Ord. no. | F PG 1571 01 01 |
| 3 Ord. no. | F PG 2071 01 01 |
| 4 Ord. no. | F PG 2571 01 01 |

ROTARY TOWER PRACTIBOX





Perfect for storing different types of material in a rational way, the Practibox rotating shelving, available in three different heights, comprises a base on which 4 Practibox container frames are fixed. The metal structure is electrophoresis painted in grey RAL 7000 and must be fixed to the floor.

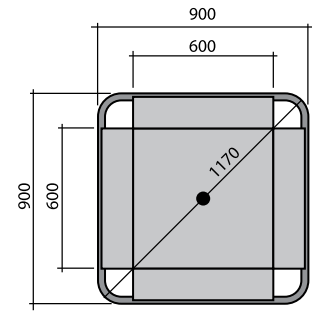
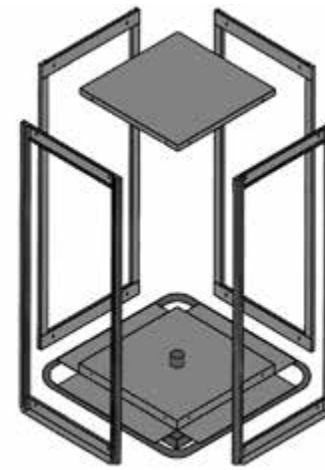

96 TRANSPARENT
OF GREY

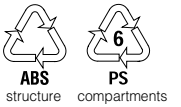

The Rotary Tower must be fixed to the floor.

ORD. NO. F PG 0226 01 01

Rotary tower with 4 frames Ord. no. F PG 0550 00 01

Including:

- 2 Ord. no. F PG 1071 01 01
- 18 Ord. no. F PG 1571 01 01
- 22 Ord. no. F PG 2071 01 01
- 6 Ord. no. F PG 2571 01 01

| | | |
|------------------------|--------|---------|
| ORD. NO. | width | mm 900 |
| | depth | mm 900 |
| F PG 0224 00 01 | height | mm 1615 |

Rotary tower **without** practibox complete with 4 frames Ord. no. **F PG 0540 00 01**

| | | |
|------------------------|--------|---------|
| ORD. NO. | width | mm 900 |
| | depth | mm 900 |
| F PG 0226 00 01 | height | mm 1865 |

Rotary tower **without** practibox complete with 4 frames Ord. no. **F PG 0550 00 01**

| | | |
|------------------------|--------|---------|
| ORD. NO. | width | mm 900 |
| | depth | mm 900 |
| F PG 0228 00 01 | height | mm 2065 |

Rotary tower **without** practibox complete with 4 frames Ord. no. **F PG 0560 00 01**



L12

**VERTICAL SYSTEM
PRACTIBOX**



L13



The Practibox vertical system comprises a modular cabinet for holding the vertical drawers onto which are fixed all models of Practibox containers. The vertical drawer is fixed to the cabinet according to the overall size of Practibox containers placed in it, so as to best exploit available space and still have easy access. The Practibox vertical system cabinet is formed of a steel modular structure, duly shaped and strengthened to support heavy loads. The drawers slide on telescopic guides mounted on ball bearings which guarantee easy and silent opening - even when full.

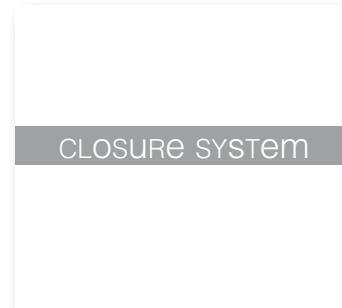

CLOSURE SYSTEM

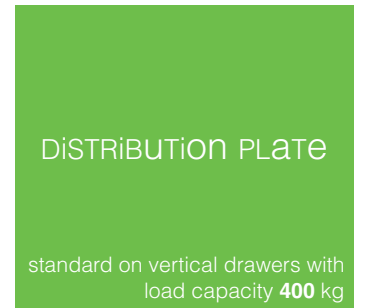

DISTRIBUTION PLATE

standard on vertical drawers with load capacity 400 kg

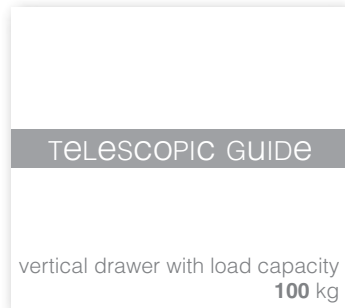

TELESCOPIC GUIDE

vertical drawer with load capacity 100 kg

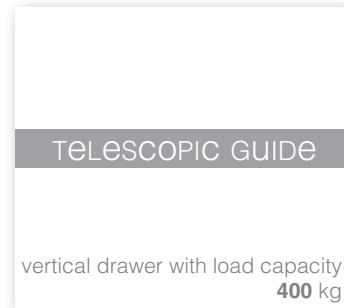

TELESCOPIC GUIDE

vertical drawer with load capacity 400 kg



These cupboards, standard supplied with a single drawer opening device, **must be fixed** to the floor or wall. The floor-fixing material, if required, can be supplied by FAMI.

fixing material

Ord. no. F SR 8999 00 99

Fixing material for a side including 2 steel expansion bolts M10x90 mm for floors in uninterrupted concrete greater than or equal to the class C20/25.



L14

cabinet without compartments Ord. no. F PG 0030 00 01

| | | | | | |
|-------|----|------|----------------|----|------|
| width | mm | 1073 | height | mm | 2000 |
| depth | mm | 705 | internal width | mm | 967 |

cabinet without compartments Ord. no. F PG 0050 00 01

| | | | | | |
|-------|----|------|----------------|----|------|
| width | mm | 1481 | height | mm | 2000 |
| depth | mm | 705 | internal width | mm | 1375 |

vertical compartments Ord. no. F PG 0010 00 01

| | | | | | |
|---------------|----|-----|-----------------|----|------|
| load capacity | kg | 100 | stacking height | mm | 1765 |
| depth | mm | 705 | total height | mm | 1900 |



full extension guide rails



fixing material Ord. no. F SR 8999 00 99

Fixing material for a side including 2 steel expansion bolts M10x90 mm for floors in uninterrupted concrete greater than or equal to the class C20/25.

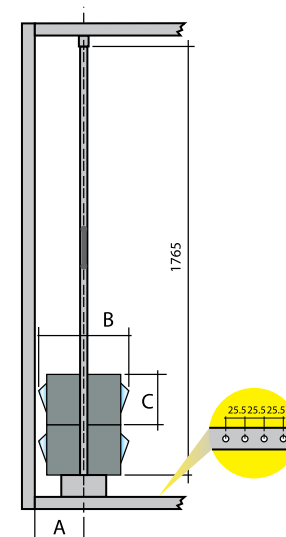

| container ORD. NO. | A | B* | C | quantity for side |
|--------------------|-------|-----|-----|-------------------|
| F PG 3571 01 01 | 330,5 | 650 | 352 | 5 |
| F PG 3071 01 01 | 228,5 | 445 | 241 | 7 |
| F PG 2571 01 01 | 203,5 | 380 | 207 | 8 |
| F PG 2071 01 01 | 177,5 | 315 | 164 | 10 |
| F PG 1571 01 01 | 126,5 | 225 | 112 | 15 |
| F PG 1071 01 01 | 101,5 | 170 | 77 | 22 |

B*- see usable cabinet width without drawers

cabinet with **4** compartments

dim. mm: 1073×705×2000 h

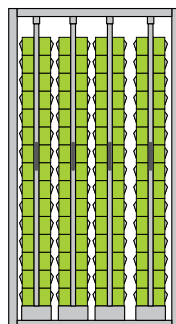

without practibox

Including

120 Ord. no. F PG 1571 01 01

| ORD. NO. | ORD. NO. |
|-----------------|-----------------|
| F PG 0035 01 01 | F PG 0030 01 01 |
| with lock | without lock |

| ORD. NO. | ORD. NO. |
|-----------------|-----------------|
| F PG 0035 51 01 | F PG 0030 51 01 |
| with lock | without lock |

cabinet with **5** compartments

dim. mm: 1481×705×2000 h

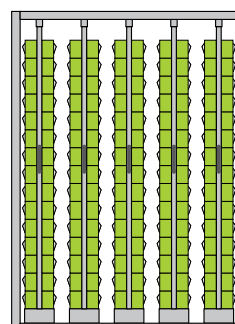

without practibox

Including

150 Ord. no. F PG 1571 01 01

| ORD. NO. | ORD. NO. |
|-----------------|-----------------|
| F PG 0055 01 01 | F PG 0050 01 01 |
| with lock | without lock |

| ORD. NO. | ORD. NO. |
|-----------------|-----------------|
| F PG 0055 51 01 | F PG 0050 51 01 |
| with lock | without lock |

cabinet with **3** compartments

dim. mm: 1073×705×2000 h

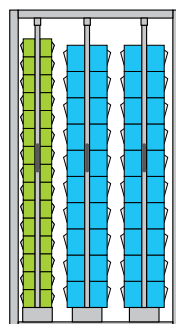

without practibox

Including

30 Ord. no. F PG 1571 01 01
40 Ord. no. F PG 2071 01 01

| ORD. NO. | ORD. NO. |
|-----------------|-----------------|
| F PG 0035 02 01 | F PG 0030 02 01 |
| with lock | without lock |

| ORD. NO. | ORD. NO. |
|-----------------|-----------------|
| F PG 0035 52 01 | F PG 0030 52 01 |
| with lock | without lock |

cabinet with **4** compartments

dim. mm: 1481×705×2000 h

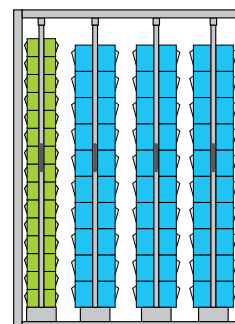

without practibox

Including

30 Ord. no. F PG 1571 01 01
60 Ord. no. F PG 2071 01 01

| ORD. NO. | ORD. NO. |
|-----------------|-----------------|
| F PG 0055 02 01 | F PG 0050 02 01 |
| with lock | without lock |

| ORD. NO. | ORD. NO. |
|-----------------|-----------------|
| F PG 0055 52 01 | F PG 0050 52 01 |
| with lock | without lock |

cabinet with **3** compartments

dim. mm: 1073×705×2000 h

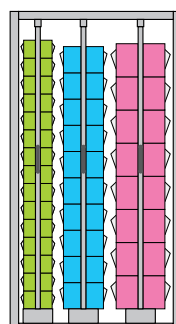

without practibox

Including

30 Ord. no. F PG 1571 01 01
20 Ord. no. F PG 2071 01 01
16 Ord. no. F PG 2571 01 01

| ORD. NO. | ORD. NO. |
|-----------------|-----------------|
| F PG 0035 03 01 | F PG 0030 03 01 |
| with lock | without lock |

| ORD. NO. | ORD. NO. |
|-----------------|-----------------|
| F PG 0035 53 01 | F PG 0030 53 01 |
| with lock | without lock |

cabinet with **3** compartments

dim. mm: 1481×705×2000 h

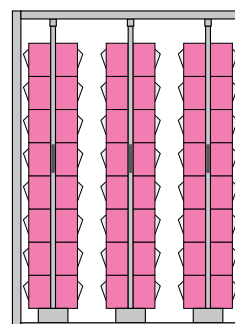

without practibox

Including

48 Ord. no. F PG 2571 01 01

| ORD. NO. | ORD. NO. |
|-----------------|-----------------|
| F PG 0055 03 01 | F PG 0050 03 01 |
| with lock | without lock |

| ORD. NO. | ORD. NO. |
|-----------------|-----------------|
| F PG 0055 53 01 | F PG 0050 53 01 |
| with lock | without lock |

cabinet without compartments Ord. no. F PG 0030 00 01

| | | | |
|-------|---------|----------------|---------|
| width | mm 1073 | height | mm 2000 |
| depth | mm 705 | internal width | mm 967 |

cabinet without compartments Ord. no. F PG 0050 00 01

| | | | |
|-------|---------|----------------|---------|
| width | mm 1481 | height | mm 2000 |
| depth | mm 705 | internal width | mm 1375 |

vertical compartments Ord. no. F PG 0011 00 01

| | | | |
|---------------|--------|-----------------|---------|
| load capacity | kg 400 | stacking height | mm 1725 |
| depth | mm 705 | total height | mm 1900 |



**COMPARTMENT LOAD
CAPACITY 400 KG**

full extension guide rails



fixing material

Ord. no. F SR 8999 00 99

Fixing material for a side including 2 steel expansion bolts M10x90 mm for floors in uninterrupted concrete greater than or equal to the class C20/25.

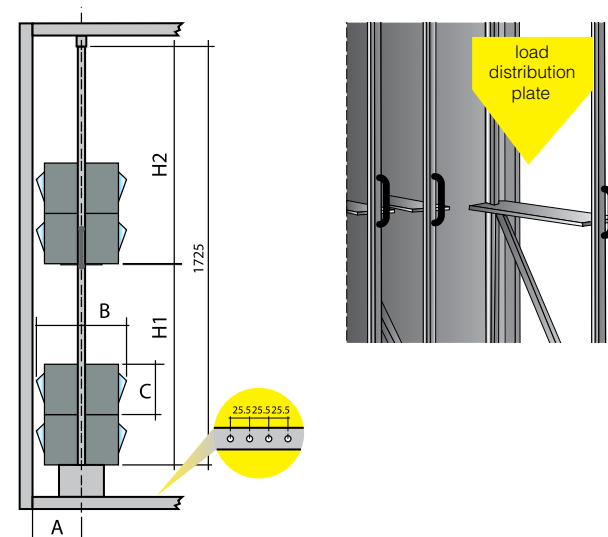

| container ORD. NO. | A | B* | C | quantity H1 | quantity H2 |
|--------------------|-------|-----|-----|-------------|-------------|
| F PG 3571 01 01 | 330,5 | 650 | 352 | 2 | 2 |
| F PG 3071 01 01 | 228,5 | 445 | 241 | 3 | 3 |
| F PG 2571 01 01 | 203,5 | 380 | 207 | 4 | 4 |
| F PG 2071 01 01 | 177,5 | 315 | 164 | 5 | 5 |
| F PG 1571 01 01 | 126,5 | 225 | 112 | 7 | 8 |
| F PG 1071 01 01 | 101,5 | 170 | 77 | 10 | 11 |

B*- see usable cabinet width without drawers

cabinet with **4** compartments

dim. mm: 1073×705×2000 h

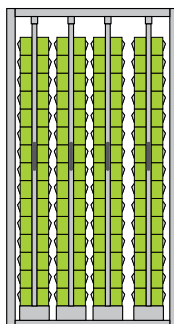

without practibox

Including

120 Ord. no. F PG 1571 01 01

| ORD. NO. | ORD. NO. |
|-----------------|-----------------|
| F PG 0036 01 01 | F PG 0031 01 01 |
| with lock | without lock |

| ORD. NO. | ORD. NO. |
|-----------------|-----------------|
| F PG 0036 51 01 | F PG 0031 51 01 |
| with lock | without lock |

cabinet with **5** compartments

dim. mm: 1481×705×2000 h

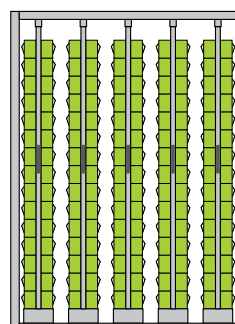

without practibox

Including

150 Ord. no. F PG 1571 01 01

| ORD. NO. | ORD. NO. |
|-----------------|-----------------|
| F PG 0056 01 01 | F PG 0051 01 01 |
| with lock | without lock |

| ORD. NO. | ORD. NO. |
|-----------------|-----------------|
| F PG 0056 51 01 | F PG 0051 51 01 |
| with lock | without lock |

cabinet with **3** compartments

dim. mm: 1073×705×2000 h

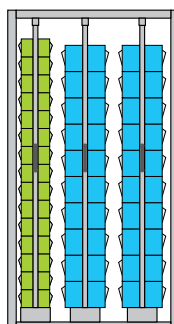

without practibox

Including

30 Ord. no. F PG 1571 01 01
40 Ord. no. F PG 2071 01 01

| ORD. NO. | ORD. NO. |
|-----------------|-----------------|
| F PG 0036 02 01 | F PG 0031 02 01 |
| with lock | without lock |

| ORD. NO. | ORD. NO. |
|-----------------|-----------------|
| F PG 0036 52 01 | F PG 0031 52 01 |
| with lock | without lock |

cabinet with **4** compartments

dim. mm: 1481×705×2000 h

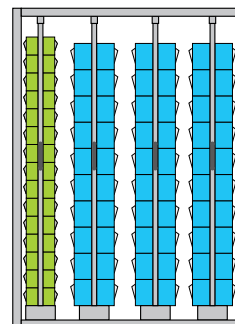

without practibox

Including

30 Ord. no. F PG 1571 01 01
60 Ord. no. F PG 2071 01 01

| ORD. NO. | ORD. NO. |
|-----------------|-----------------|
| F PG 0056 02 01 | F PG 0051 02 01 |
| with lock | without lock |

| ORD. NO. | ORD. NO. |
|-----------------|-----------------|
| F PG 0056 52 01 | F PG 0051 52 01 |
| with lock | without lock |

cabinet with **3** compartments

dim. mm: 1073×705×2000 h

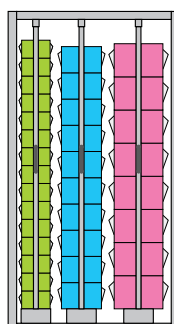

without practibox

Including

30 Ord. no. F PG 1571 01 01
20 Ord. no. F PG 2071 01 01
16 Ord. no. F PG 2571 01 01

| ORD. NO. | ORD. NO. |
|-----------------|-----------------|
| F PG 0036 03 01 | F PG 0031 03 01 |
| with lock | without lock |

| ORD. NO. | ORD. NO. |
|-----------------|-----------------|
| F PG 0036 53 01 | F PG 0031 53 01 |
| with lock | without lock |

cabinet with **3** compartments

dim. mm: 1481×705×2000 h

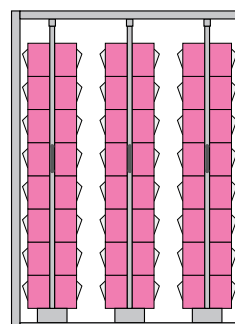

without practibox

Including

48 Ord. no. F PG 2571 01 01

| ORD. NO. | ORD. NO. |
|-----------------|-----------------|
| F PG 0056 03 01 | F PG 0051 03 01 |
| with lock | without lock |

| ORD. NO. | ORD. NO. |
|-----------------|-----------------|
| F PG 0056 53 01 | F PG 0051 53 01 |
| with lock | without lock |

TOP BOX CASE

This comprises 18 compartments made from transparent polystyrene with high mechanical resistance and is fitted with hooks, perfect for storing screwdrivers, scissors and tools, etc..

96 TRANSPARENT
04 14 11



ergonomic handle
stacking joint
tool tray
universal holder
high-proof pull-out plastic container
total pull-out safety mechanism
strong frame supports
tool holder
label holder
compartments with high mechanical resistance



Ord. no. F PG 5561 01 04

Complete with 18 compartments

drawer dimensions

width mm 350
depth mm 200
height mm 465

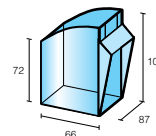

Locking

A handy bar closes the container to hold articles securely when carrying. The structure is realized in tough, shock-resistant material.



ACCESSORIES
CONTAINERS



LOCKING BARS FOR CONTAINERS

Practibox series containers can be fitted in service cars and vans. The simple and practical locking bars prevents opening and subsequent loss of contents in the event of sudden braking. Realized in galvanized steel rod.

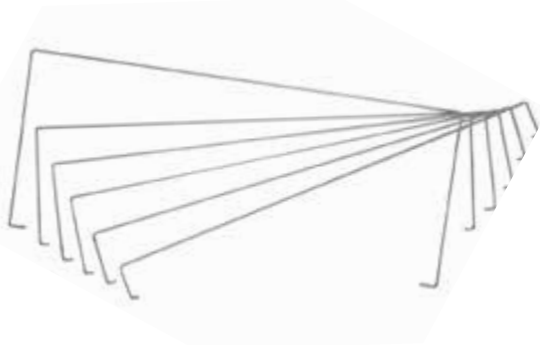

| ORD. NO. | | for containers ORD. NO. |
|-----------------|--|----------------------------|
| F PG 0910 00 99 | | F PG 1071 01 01 |
| F PG 0915 00 99 | | F PG 1571 01 01 |
| F PG 0920 00 99 | | F PG 2071 01 01 |
| F PG 0925 00 99 | | F PG 2571 01 01 |
| F PG 0930 00 99 | | F PG 3071 01 01 |
| F PG 0935 00 99 | | F PG 3571 01 01 |

99 HOT GALVANISED

LABELS

The paper labels make the container's contents easier to identify by clearly showing the codes and/or articles. The relative label has been foreseen for each type of container.



| label sheet | dim. label | no. labels per sheet | for containers ORD. NO. |
|-----------------|------------|-------------------------|----------------------------|
| F PG 9020 00 00 | 35×10 mm | 9 | F PG 1071 01 01 |
| F PG 9040 00 00 | 53×15 mm | 6 | F PG 1571 01 01 |
| F PG 9060 00 00 | 80×22 mm | 5 | F PG 2071 01 01 |
| F PG 9080 00 00 | 80×28 mm | 4 | F PG 2571 01 01 |
| F PG 9100 00 00 | 121×34 mm | 3 | F PG 3071 01 01 |
| F PG 9120 00 00 | 121×50 mm | 2 | F PG 3571 01 01 |



CONDUCTIVE SYSTEM M





PaGe

M 3

conductive stacking containers series
ATHENA

p.c.b. handling frame system

MEGAPRINT®
MINIPRINT®

PaGe

M 17

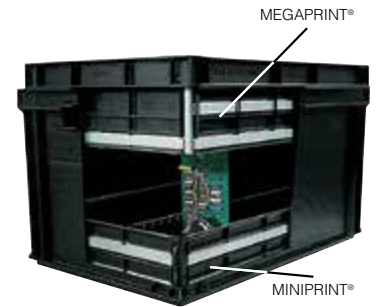

PaGe

M 23

CARD
carrying frame

conductive storage
CONTAINERS

PaGe

M 27



PaGe

M 27

MULTIBOX
boxes series F PK

conductive
FLOORING
MATS

PaGe

M 27



M2

CONDUCTIVE STACKING CONTAINERS SERIES

ATHENA



M3

FAMI Athena conductive containers are produced in conductive plastic in basic sizes of 300x200 mm, 400x300 mm and 600x400 mm, with a variety of depths. These base measurements are subdivisions of the 1200x800 mm Europallet, and as such create a standard modular system. The special external ribbing makes the FAMI system particularly robust, especially when stacked. Side handles make handling safe and easy, and the lid, whilst protecting the contents from dust and dirt, does not inhibit stacking. The smooth internal design makes cleaning easy and the special base allows for the use of the containers on any style of conveyors. The FAMI series of containers are designed to accept both the Megaprint® and Miniprint® systems and to keep safe all types of electronic components from electrostatic damage.



special conductive plastic

FAMI 408 L

particularly suitable for the electronics industry

technical

SPECIFICATIONS

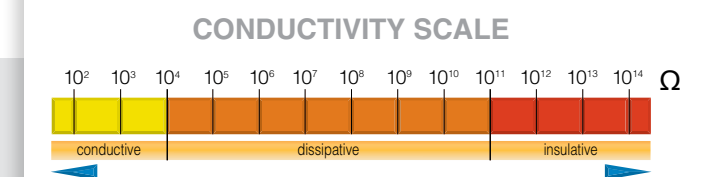

| | |
|-----------------------|--------------------------------------------------------------------------------------------------------------------------|
| BASE MATERIAL | Polypropylene copolymer (PPC) |
| CONDUCTIVITY ADDITIVE | Carbon black |
| COLOUR | Black |
| DENSITY, AT 23°C | 1.04 g/cm ³ |
| VICAT SOFTENING POINT | 154° C ISO 306 |
| WORKING TEMPERATURE | Continuous: approx 80-100°C Short term: approx 100-120°C |
| SURFACE RESISTANCE | less than 10 ⁴ Ω cm (measured according to CEI EN 61340-2-3 at 20°C with a 5 cm ² ring electrode). |
| VOLUME RESISTIVITY | 10 ⁴ Ω cm (measured according to CEI EN 61340-2-3 at 20°C with a 5 cm ² ring electrode). |
| AGEING BEHAVIOUR | No deterioration of conductivity (in 7 years of service), no leaching of corrosive substances, excellent UV resistance. |
| CHEMICAL RESISTANCE | Excellent (according to the generally valid PP classification). |

ATHENA

The **Athena Conductive** containers are made in **many versions** to suit **every need**.

07 BLACK

| container ORD. NO. | A | B | C | D | E | F | G | H | I | L | M |
|--------------------|-----|-----|-----|-----|-----|-----|-----|-----|-----|-----|-----|
| F PA 2452 A0 07 | 299 | 268 | 260 | 266 | 103 | 121 | 201 | 169 | 158 | 165 | |
| F PA 3252 A0 07 | 402 | 366 | 356 | 364 | 36 | 55 | 301 | 266 | 255 | 264 | |
| F PA 3652 A0 07 | 401 | 367 | 355 | 363 | 57 | 75 | 300 | 266 | 255 | 262 | |
| F PA 4052 A0 07 | 402 | 370 | 358 | 366 | 103 | 121 | 301 | 270 | 258 | 264 | |
| F PA 4452 A0 07 | 401 | 370 | 357 | 367 | 152 | 171 | 300 | 269 | 257 | 267 | |
| F PA 4852 A0 07 | 402 | 371 | 358 | 366 | 203 | 222 | 302 | 269 | 258 | 267 | |
| F PA 5252 A0 07 | 402 | 371 | 355 | 368 | 306 | 325 | 301 | 268 | 258 | 267 | |
| F PA 5652 A0 07 | 604 | 566 | 555 | 564 | 57 | 77 | 404 | 365 | 354 | 364 | 607 |
| F PA 6052 A0 07 | 604 | 572 | 557 | 569 | 102 | 121 | 403 | 371 | 357 | 367 | 607 |
| F PA 6452 A0 07 | 605 | 573 | 558 | 568 | 152 | 172 | 403 | 370 | 358 | 367 | 606 |
| F PB 6852 A0 07 | 604 | 570 | 557 | 567 | 199 | 221 | 402 | 366 | 357 | 362 | 607 |
| F PA 7252 A0 07 | 603 | 571 | 557 | 563 | 263 | 281 | 402 | 371 | 357 | 363 | 607 |
| F PA 7652 A0 07 | 604 | 572 | 558 | 567 | 308 | 327 | 403 | 372 | 358 | 366 | 606 |
| F PA 8052 B0 07 | 603 | 573 | 558 | 567 | 413 | 432 | 402 | 369 | 357 | 366 | 604 |
| F PA 8552 A0 07 | 806 | 772 | 758 | 764 | 85 | 121 | 606 | 570 | 555 | 564 | 825 |
| F PA 8752 A0 07 | 806 | 771 | 757 | 764 | 136 | 172 | 605 | 569 | 556 | 563 | 824 |
| F PA 8952 A0 07 | 807 | 770 | 758 | 766 | 187 | 223 | 605 | 569 | 557 | 565 | 823 |
| F PA 9352 A0 07 | 806 | 770 | 757 | 765 | 293 | 328 | 604 | 569 | 557 | 563 | 822 |
| F PA 9752 A0 07 | 805 | 772 | 758 | 763 | 393 | 428 | 603 | 569 | 557 | 563 | 824 |

The technical data contained in the above table is approximate. FAMI S.r.l. reserves the right to make any modifications it sees fit to improve the performance and appearance of products. The manufacturer is not liable for any printing errors.

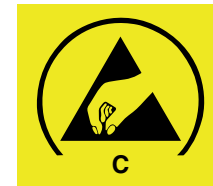
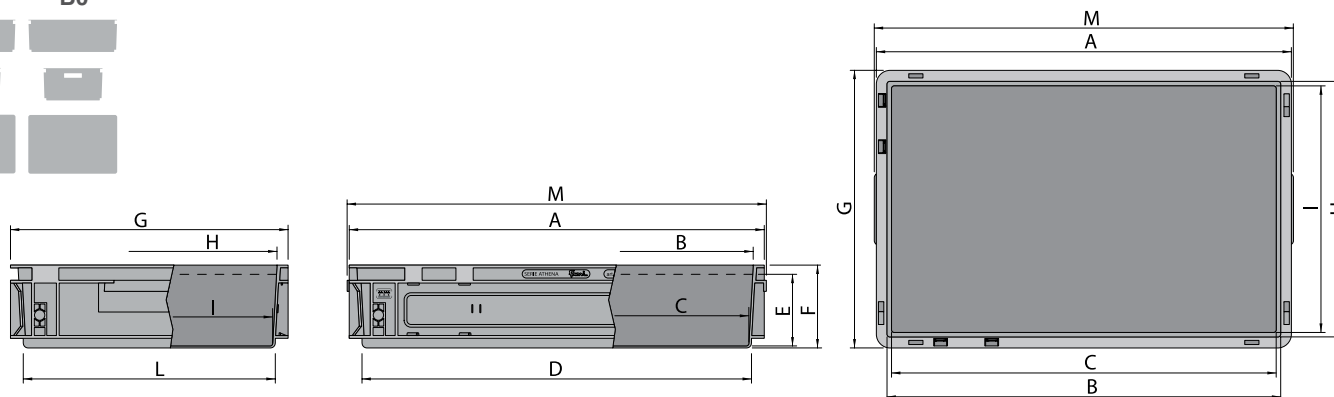
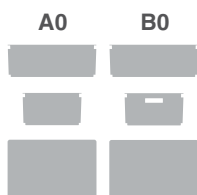

Detail of **SOLID BOTTOM**

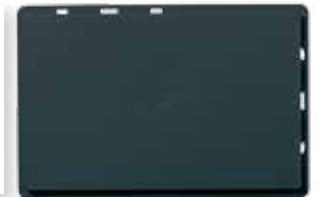

*Athena **800x600**. A smooth bottom is available on all containers on request and with a minimum order quantity.

Detail of **REINFORCED BOTTOM**



*Athena **400x300** and **600x400**. A reinforced bottom is available on all containers on request and with a minimum order quantity.

ACCESSORIES
PAGE
M11



SOLID BOTTOM

ORD. NO. F PA 2452 A0 07 -single

| | |
|------------------|------------|
| Measurements: | EL3212A |
| Standard colour: | 07 black ■ |

| | |
|---------------------------|---------------|
| Weight gr.: | 514 |
| External nominal dim. mm: | 300×200×120 h |
| Internal nominal dim. mm: | 260×158×103 h |

ORD. NO. F YA 2452 A0 07 -pallet

| | |
|-----------------------------|-----------------|
| Weight of pallet kg: | 173 |
| Qty. Containers per pallet: | 320 pcs. |
| Shipping dimensions mm: | 1200×800×2240 h |



SOLID BOTTOM

ORD. NO. F PA 3252 A0 07 -single

| | |
|------------------|------------|
| Measurements: | EL4305A |
| Standard colour: | 07 black ■ |

| | |
|---------------------------|--------------|
| Weight gr.: | 544 |
| External nominal dim. mm: | 400×300×55 h |
| Internal nominal dim. mm: | 356×255×36 h |

ORD. NO. F YA 3252 A0 07 -pallet

| | |
|-----------------------------|-----------------|
| Weight of pallet kg: | 183 |
| Qty. Containers per pallet: | 320 pcs. |
| Shipping dimensions mm: | 1200×800×1730 h |



SOLID BOTTOM

ORD. NO. F PA 3652 A0 07 -single

| | |
|------------------|------------|
| Measurements: | EL4308A |
| Standard colour: | 07 black ■ |

| | |
|---------------------------|--------------|
| Weight gr.: | 636 |
| External nominal dim. mm: | 400×300×75 h |
| Internal nominal dim. mm: | 355×255×57 h |

ORD. NO. F YA 3652 A0 07 -pallet

| | |
|-----------------------------|-----------------|
| Weight of pallet kg: | 162 |
| Qty. Containers per pallet: | 240 pcs. |
| Shipping dimensions mm: | 1200×800×1960 h |



SOLID BOTTOM

ORD. NO. F PA 4052 A0 07 -single

| | |
|------------------|------------|
| Measurements: | EL4312A |
| Standard colour: | 07 black ■ |

| | |
|---------------------------|---------------|
| Weight gr.: | 868 |
| External nominal dim. mm: | 400×300×120 h |
| Internal nominal dim. mm: | 358×258×103 h |

ORD. NO. F YA 4052 A0 07 -pallet

| | |
|-----------------------------|-----------------|
| Weight of pallet kg: | 148 |
| Qty. Containers per pallet: | 160 pcs. |
| Shipping dimensions mm: | 1200×800×2230 h |



SOLID BOTTOM

ORD. NO. F PA 4452 A0 07 -single

| | |
|------------------|------------|
| Measurements: | EL4317A |
| Standard colour: | 07 black ■ |

| | |
|---------------------------|---------------|
| Weight gr.: | 1232 |
| External nominal dim. mm: | 400×300×170 h |
| Internal nominal dim. mm: | 357×257×152 h |

ORD. NO. F YA 4452 A0 07 -pallet

| | |
|-----------------------------|-----------------|
| Weight of pallet kg: | 137 |
| Qty. Containers per pallet: | 104 pcs. |
| Shipping dimensions mm: | 1200×800×2150 h |



SOLID BOTTOM

ORD. NO. F PA 4852 A0 07 -single

| | |
|------------------|------------|
| Measurements: | EL4322A |
| Standard colour: | 07 black ■ |

| | |
|---------------------------|---------------|
| Weight gr.: | 1614 |
| External nominal dim. mm: | 400×300×220 h |
| Internal nominal dim. mm: | 358×258×203 h |

ORD. NO. F YA 4852 A0 07 -pallet

| | |
|-----------------------------|-----------------|
| Weight of pallet kg: | 138 |
| Qty. Containers per pallet: | 80 pcs. |
| Shipping dimensions mm: | 1200×800×2200 h |



SOLID BOTTOM

ORD. NO. F PA 5252 A0 07 -single

| | |
|------------------|------------|
| Measurements: | EL4332A |
| Standard colour: | 07 black ■ |

| | |
|---------------------------|---------------|
| Weight gr.: | 2112 |
| External nominal dim. mm: | 400×300×325 h |
| Internal nominal dim. mm: | 355×258×306 h |

ORD. NO. F YA 5252 A0 07 -pallet

| | |
|-----------------------------|-----------------|
| Weight of pallet kg: | 127 |
| Qty. Containers per pallet: | 56 pcs. |
| Shipping dimensions mm: | 1200×800×2300 h |



SOLID BOTTOM

ORD. NO. F PA 5652 A0 07 -single

| | |
|------------------|------------|
| Measurements: | EL6408A |
| Standard colour: | 07 black ■ |

| | |
|---------------------------|--------------|
| Weight gr.: | 1466 |
| External nominal dim. mm: | 600×400×75 h |
| Internal nominal dim. mm: | 555×354×57 h |

ORD. NO. F YA 5652 A0 07 -pallet

| | |
|-----------------------------|-----------------|
| Weight of pallet kg: | 185 |
| Qty. Containers per pallet: | 120 pcs. |
| Shipping dimensions mm: | 1200×800×1970 h |



SOLID BOTTOM

ORD. NO. F PA 6052 A0 07 -single

| | |
|------------------|------------|
| Measurements: | EL6412A |
| Standard colour: | 07 black ■ |

| | |
|---------------------------|---------------|
| Weight gr.: | 1882 |
| External nominal dim. mm: | 600×400×120 h |
| Internal nominal dim. mm: | 557×357×102 h |

ORD. NO. F YA 6052 A0 07 -pallet

| | |
|-----------------------------|-----------------|
| Weight of pallet kg: | 160 |
| Qty. Containers per pallet: | 80 pcs. |
| Shipping dimensions mm: | 1200×800×2240 h |



SOLID BOTTOM

ORD. NO. F PA 6452 A0 07 -single

| | |
|------------------|------------|
| Measurements: | EL6417A |
| Standard colour: | 07 black ■ |

| | |
|---------------------------|---------------|
| Weight gr.: | 2430 |
| External nominal dim. mm: | 600×400×170 h |
| Internal nominal dim. mm: | 558×358×152 h |

ORD. NO. F YA 6452 A0 07 -pallet

| | |
|-----------------------------|-----------------|
| Weight of pallet kg: | 145 |
| Qty. Containers per pallet: | 56 pcs. |
| Shipping dimensions mm: | 1200×800×2330 h |



SOLID BOTTOM

ORD. NO. F PB 6852 A0 07 -single

| | |
|------------------|------------|
| Measurements: | EL6422-TA |
| Standard colour: | 07 black ■ |

| | |
|---------------------------|---------------|
| Weight gr.: | 2250 |
| External nominal dim. mm: | 600×400×220 h |
| Internal nominal dim. mm: | 557×357×199 h |

ORD. NO. F YB 6852 A0 07 -pallet

| | |
|-----------------------------|-----------------|
| Weight of pallet kg: | 99 |
| Qty. Containers per pallet: | 40 pcs. |
| Shipping dimensions mm: | 1200×800×2200 h |



SOLID BOTTOM

ORD. NO. F PA 7252 A0 07 -single

| | |
|------------------|------------|
| Measurements: | EL6428A |
| Standard colour: | 07 black ■ |

| | |
|---------------------------|---------------|
| Weight gr.: | 3128 |
| External nominal dim. mm: | 600×400×280 h |
| Internal nominal dim. mm: | 557×357×263 h |

ORD. NO. F YA 7252 A0 07 -pallet

| | |
|-----------------------------|-----------------|
| Weight of pallet kg: | 109 |
| Qty. Containers per pallet: | 32 pcs. |
| Shipping dimensions mm: | 1200×800×2270 h |



SOLID BOTTOM

ORD. NO. F PA 7652 A0 07 -single

| | |
|------------------|------------|
| Measurements: | EL6432A |
| Standard colour: | 07 black ■ |
| | |

| | |
|---------------------------|---------------|
| Weight gr.: | 3460 |
| External nominal dim. mm: | 600×400×325 h |
| Internal nominal dim. mm: | 558×358×308 h |

ORD. NO. F YA 7652 A0 07 -pallet

| | |
|-----------------------------|-----------------|
| Weight of pallet kg: | 106 |
| Qty. Containers per pallet: | 28 pcs. |
| Shipping dimensions mm: | 1200×800×2300 h |



SOLID BOTTOM

ORD. NO. F PA 8052 B0 07 -single

| | |
|------------------|------------|
| Measurements: | EL6443B |
| Standard colour: | 07 black ■ |
| | |

| | |
|---------------------------|---------------|
| Weight gr.: | 4250 |
| External nominal dim. mm: | 600×400×430 h |
| Internal nominal dim. mm: | 558×357×413 h |

ORD. NO. F YA 8052 B0 07 -pallet

| | |
|-----------------------------|-----------------|
| Weight of pallet kg: | 94 |
| Qty. Containers per pallet: | 20 pcs. |
| Shipping dimensions mm: | 1200×800×2200 h |





REINFORCED BOTTOM



ORD. NO. F PA 8552 A0 07 -single

| | |
|------------------|------------|
| Measurements: | EL8612A FR |
| Standard colour: | 07 black ■ |

| | |
|---------------------------|---------------|
| Weight gr.: | 3920 |
| External nominal dim. mm: | 800×600×120 h |
| Internal nominal dim. mm: | 758×555×85 h |

ORD. NO. F YA 8552 A0 07 -pallet

| | |
|-----------------------------|-----------------|
| Weight of pallet kg: | 166 |
| Qty. Containers per pallet: | 40 pcs. |
| Shipping dimensions mm: | 1200×800×2300 h |



REINFORCED BOTTOM



ORD. NO. F PA 8752 A0 07 -single

| | |
|------------------|------------|
| Measurements: | EL8617A FR |
| Standard colour: | 07 black ■ |

| | |
|---------------------------|---------------|
| Weight gr.: | 4356 |
| External nominal dim. mm: | 800×600×170 h |
| Internal nominal dim. mm: | 757×556×136 h |

ORD. NO. F YA 8752 A0 07 -pallet

| | |
|-----------------------------|-----------------|
| Weight of pallet kg: | 131 |
| Qty. Containers per pallet: | 28 pcs. |
| Shipping dimensions mm: | 1200×800×2300 h |



REINFORCED BOTTOM



ORD. NO. F PA 8952 A0 07 -single

| | |
|------------------|------------|
| Measurements: | EL8622A FR |
| Standard colour: | 07 black ■ |

| | |
|---------------------------|---------------|
| Weight gr.: | 5310 |
| External nominal dim. mm: | 800×600×220 h |
| Internal nominal dim. mm: | 758×557×187 h |

ORD. NO. F YA 8952 A0 07 -pallet

| | |
|-----------------------------|-----------------|
| Weight of pallet kg: | 115 |
| Qty. Containers per pallet: | 20 pcs. |
| Shipping dimensions mm: | 1200×800×2200 h |



REINFORCED BOTTOM



ORD. NO. F PA 9352 A0 07 -single

| | |
|------------------|------------|
| Measurements: | EL8632A FR |
| Standard colour: | 07 black ■ |

| | |
|---------------------------|---------------|
| Weight gr.: | 5780 |
| External nominal dim. mm: | 800×600×325 h |
| Internal nominal dim. mm: | 757×557×293 h |

ORD. NO. F YA 9352 A0 07 -pallet

| | |
|-----------------------------|-----------------|
| Weight of pallet kg: | 90 |
| Qty. Containers per pallet: | 14 pcs. |
| Shipping dimensions mm: | 1200×800×2320 h |



REINFORCED BOTTOM



ORD. NO. F PA 9752 A0 07 -single

| | |
|------------------|------------|
| Measurements: | EL8643A FR |
| Standard colour: | 07 black ■ |

| | |
|---------------------------|---------------|
| Weight gr.: | 6750 |
| External nominal dim. mm: | 800×600×430 h |
| Internal nominal dim. mm: | 758×557×393 h |

ORD. NO. F YA 9752 A0 07 -pallet

| | |
|-----------------------------|-----------------|
| Weight of pallet kg: | 76 |
| Qty. Containers per pallet: | 10 pcs. |
| Shipping dimensions mm: | 1200×800×2230 h |



ACCESSORIES
PAGE
M11

CONTAINER SUPPLIED ASSEMBLED

container including 1 set of four feet



| ORD. NO. | DIM. mm | Capacity litres |
|----------------------------|---------------|-----------------|
| F PA 8552 AD 07 | 800x600x220 h | 49 |
| Measurements | EL8612A-P | |
| With 120 mm high container | | |

| ORD. NO. | DIM. mm | Capacity litres |
|----------------------------|---------------|-----------------|
| F PA 8752 AD 07 | 800x600x270 h | 69 |
| Measurements | EL8617A-P | |
| With 170 mm high container | | |

| ORD. NO. | DIM. mm | Capacity litres |
|----------------------------|---------------|-----------------|
| F PA 8952 AD 07 | 800x600x320 h | 90 |
| Measurements | EL8622A-P | |
| With 220 mm high container | | |

| ORD. NO. | DIM. mm | Capacity litres |
|----------------------------|---------------|-----------------|
| F PA 9352 AD 07 | 800x600x425 h | 130 |
| Measurements | EL8632A-P | |
| With 325 mm high container | | |

| ORD. NO. | DIM. mm | Capacity litres |
|----------------------------|---------------|-----------------|
| F PA 9752 AD 07 | 800x600x530 h | 175 |
| Measurements | EL8643A-P | |
| With 430 mm high container | | |

container including 1 set of four feet and 1 pair of connection pieces



| ORD. NO. | DIM. mm | Capacity litres |
|----------------------------|---------------|-----------------|
| F PA 8552 AE 07 | 800x600x245 h | 49 |
| Measurements | EL8612A-T | |
| With 120 mm high container | | |

| ORD. NO. | DIM. mm | Capacity litres |
|----------------------------|---------------|-----------------|
| F PA 8752 AE 07 | 800x600x295 h | 69 |
| Measurements | EL8617A-T | |
| With 170 mm high container | | |

| ORD. NO. | DIM. mm | Capacity litres |
|----------------------------|---------------|-----------------|
| F PA 8952 AE 07 | 800x600x345 h | 90 |
| Measurements | EL8622A-T | |
| With 220 mm high container | | |

| ORD. NO. | DIM. mm | Capacity litres |
|----------------------------|---------------|-----------------|
| F PA 9352 AE 07 | 800x600x450 h | 130 |
| Measurements | EL8632A-T | |
| With 325 mm high container | | |

| ORD. NO. | DIM. mm | Capacity litres |
|----------------------------|---------------|-----------------|
| F PA 9752 AE 07 | 800x600x555 h | 175 |
| Measurements | EL8643A-T | |
| With 430 mm high container | | |

container including 1 set of four 100 mm Ø conductive swivel wheels



| ORD. NO. | DIM. mm | Capacity litres |
|----------------------------|---------------|-----------------|
| F PA 8552 AF 07 | 800x600x245 h | 49 |
| Measurements | EL8612A-R | |
| With 120 mm high container | | |

| ORD. NO. | DIM. mm | Capacity litres |
|----------------------------|---------------|-----------------|
| F PA 8752 AF 07 | 800x600x295 h | 69 |
| Measurements | EL8617A-R | |
| With 170 mm high container | | |

| ORD. NO. | DIM. mm | Capacity litres |
|----------------------------|---------------|-----------------|
| F PA 8952 AF 07 | 800x600x345 h | 90 |
| Measurements | EL8622A-R | |
| With 220 mm high container | | |

| ORD. NO. | DIM. mm | Capacity litres |
|----------------------------|---------------|-----------------|
| F PA 9352 AF 07 | 800x600x450 h | 130 |
| Measurements | EL8632A-R | |
| With 325 mm high container | | |

| ORD. NO. | DIM. mm | Capacity litres |
|----------------------------|---------------|-----------------|
| F PA 9752 AF 07 | 800x600x555 h | 175 |
| Measurements | EL8643A-R | |
| With 430 mm high container | | |



The containers can be stacked thanks to the 4 feet which enter inside the container below



The 2 connection pieces allow the containers to be stacked



The containers can be stacked thanks to the 4 wheels which enter inside the container below

ACCESSORIES
ATHENA
CONDUCTIVE



M11

LIDS

The lids are designed to protect the contents of the containers from dust and dirt and to provide a full Faraday Cage effect when closed. Produced in Conductive Co-polymer Polypropylene, all lids are hinged and detachable, therefore they do not inhibit stacking.



300x200

hinged lid

| ORD. NO. | Hinged lid mm |
|-----------------|---------------|
| F PA 0352 00 07 | 300x200 |
| Weight gr. | 174 |



400x300

hinged lid

| ORD. NO. | Hinged lid mm |
|-----------------|---------------|
| F PA 0652 00 07 | 400x300 |
| Weight gr. | 354 |



600x400

hinged lid

| ORD. NO. | Hinged lid mm |
|-----------------|---------------|
| F PA 0952 00 07 | 600x400 |
| Weight gr. | 736 |



lid with handles

| ORD. NO. | Lid with handles mm |
|-----------------|---------------------|
| F PA 1B52 00 07 | 400x300 |
| Weight gr. | 360 |

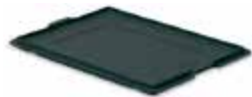

| ORD. NO. | Lid with handles mm |
|-----------------|---------------------|
| F PA 1C52 00 07 | 600x400 |
| Weight gr. | 838 |



sliding lid

The cover cannot be used on containers in the shelving system F TR

| ORD. NO. | Sliding lid mm |
|-----------------|----------------|
| F PA 1652 00 07 | 400x300 |
| Weight gr. | 518 |



800x600

lid with handles

| ORD. NO. | Lid with handles mm |
|-----------------|---------------------|
| F PA 1252 01 07 | 800x600 |
| Weight gr. | 2142 |



07 BLACK

LID CATCHES

SPECIAL LABELS

Page Q1



Pair of lid catches. Suitable for all containers.

ORD. NO. F PZ 0681 00 13



ORD. NO. F PZ 0010 00 99

metal clips



For all Athena series stacking containers



13 WHITE
99 HOT GALVANISED

M12

SUB-DIVIDING CONTAINERS



A range of kitting trays, with moulded dividers, are made to fit into our containers to further enhance their use. Each tray is made with three variations: 1, 2 or 4 compartments. Any two kitting trays part numbers F PP 4052 00 07, F PP 4552 00 07, or F PP 5052 00 07 will fit beside each other into the 43 series containers. Any two kitting trays part numbers F PP 6052 00 07, F PP 6552 00 07 or F PP 7052 00 07 will fit beside each other into the 64 series containers. **The kitting trays can also stack on each other inside the deeper containers**, to provide high density storage.



400x300

600x400



| ORD. NO. | External DIM. mm | ORD. NO. | External DIM. mm | ORD. NO. | External DIM. mm |
|-----------------|------------------|-----------------|------------------|-----------------|------------------|
| F PP 4052 00 07 | 256x178x90 h | F PP 4552 00 07 | 256x178x90 h | F PP 5052 00 07 | 256x178x90 h |

| ORD. NO. | External DIM. mm | ORD. NO. | External DIM. mm | ORD. NO. | External DIM. mm |
|-----------------|------------------|-----------------|------------------|-----------------|------------------|
| F PP 6052 00 07 | 357x278x90 h | F PP 6552 00 07 | 357x278x90 h | F PP 7052 00 07 | 357x278x90 h |



stacking container divided with
1 ORD. NO. **F PP 4052 00 07**
1 ORD. NO. **F PP 4552 00 07**



stacking container divided with
1 ORD. NO. **F PP 4052 00 07**
1 ORD. NO. **F PP 5052 00 07**



stacking container divided with
1 ORD. NO. **F PP 4552 00 07**
1 ORD. NO. **F PP 5052 00 07**



stacking container divided with
1 ORD. NO. **F PP 6052 00 07**
1 ORD. NO. **F PP 6552 00 07**



stacking container divided with
1 ORD. NO. **F PP 6052 00 07**
1 ORD. NO. **F PP 7052 00 07**



stacking container divided with
1 ORD. NO. **F PP 6552 00 07**
1 ORD. NO. **F PP 7052 00 07**

07 BLACK

LABEL HOLDER

Identification labels and holders are now available to fit directly onto the sides of the FAMI **Euro-stacking containers**. The injection molded label holder clips into formings on **the outside** of the **container walls**. **They can be fitted onto either the short or long wall or both if needed**. The benefits of labelling are many and will greatly assist all production and storage processes and stock inventory.

400x300



| Ord. no. | dim. label mm | label sheet |
|-----------------|---------------|-----------------|
| F PZ 9551 00 07 | 145x81 | F PZ 0920 00 00 |

4 labels per sheet

EXCLUDING Athena Ord. No. F PA 3252 A0 07 - F PA 3652 A0 07
F PA 4052 A0 07

600x400



| Ord. no. | dim. label mm | label sheet |
|-----------------|---------------|-----------------|
| F PZ 9751 00 07 | 210x81 | F PZ 0940 00 00 |

3 labels per sheet

EXCLUDING Athena Ord. No. F PA 5652 A0 07 - F PA 6052 A0 07

800x600



| Ord. no. | dim. label mm | label sheet |
|-----------------|---------------|-----------------|
| F PZ 9751 00 07 | 210x81 | F PZ 0940 00 00 |

3 labels per sheet

EXCLUDING Athena Ord. No. F PA 8552 A0 07



SPECIAL LABELS
Page Q1

M13

07 BLACK

SLOTTED PARTITIONS



These dividers are suitable for the storage and transportation of delicate items which can be stored together but should not touch. **The slotted partitions are made from 3 mm thick conductive plastic sheets and are slotted in increments of 20 mm.** The slotted partitions are available in various dimensions. A vast quantity of layouts can be achieved with this system. **As an accessory, a plastic cover suitable as a lid or intermediate plate can be supplied.** This cover is fitted with 2 openings which simplifies its retrieval.



slotted partitions 400x300

height mm 45 h

height mm 70 h

height mm 90 h

height mm 120 h

height mm 180 h



| ORD. NO. | DIM. mm | Increments mm |
|-----------------|---------|---------------|
| F HP 1320 00 07 | 255x45 | 20 |
| F HP 1420 00 07 | 355x45 | 20 |

| ORD. NO. | DIM. mm | Increments mm |
|-----------------|---------|---------------|
| F HP 1340 00 07 | 255x70 | 20 |
| F HP 1440 00 07 | 355x70 | 20 |

| ORD. NO. | DIM. mm | Increments mm |
|-----------------|---------|---------------|
| F HP 1350 00 07 | 255x90 | 20 |
| F HP 1450 00 07 | 355x90 | 20 |

| ORD. NO. | DIM. mm | Increments mm |
|-----------------|---------|---------------|
| F HP 1360 00 07 | 255x120 | 20 |
| F HP 1460 00 07 | 355x120 | 20 |

| ORD. NO. | DIM. mm | Increments mm |
|-----------------|---------|---------------|
| F HP 1370 00 07 | 255x180 | 20 |
| F HP 1470 00 07 | 355x180 | 20 |

INTERMEDIATE SHELF

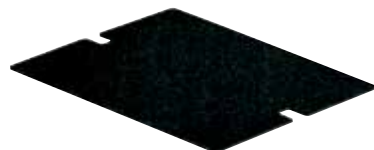

| ORD. NO. | DIM. mm |
|-----------------|---------|
| F HP 5130 00 07 | 355x255 |



slotted partitions 600x400

height mm 45 h

height mm 70 h

height mm 90 h

height mm 120 h

height mm 180 h



| ORD. NO. | DIM. mm | Increments mm |
|-----------------|---------|---------------|
| F HP 1420 00 07 | 355x45 | 20 |
| F HP 1620 00 07 | 555x45 | 20 |

| ORD. NO. | DIM. mm | Increments mm |
|-----------------|---------|---------------|
| F HP 1440 00 07 | 355x70 | 20 |
| F HP 1640 00 07 | 555x70 | 20 |

| ORD. NO. | DIM. mm | Increments mm |
|-----------------|---------|---------------|
| F HP 1450 00 07 | 355x90 | 20 |
| F HP 1650 00 07 | 555x90 | 20 |

| ORD. NO. | DIM. mm | Increments mm |
|-----------------|---------|---------------|
| F HP 1460 00 07 | 355x120 | 20 |
| F HP 1660 00 07 | 555x120 | 20 |

| ORD. NO. | DIM. mm | Increments mm |
|-----------------|---------|---------------|
| F HP 1470 00 07 | 355x180 | 20 |
| F HP 1670 00 07 | 555x180 | 20 |

INTERMEDIATE SHELF



| ORD. NO. | DIM. mm |
|-----------------|---------|
| F HP 5140 00 07 | 555x355 |



CASTORS

Feet, connection pieces and Antistatic castors for conductive stacking containers series **Athena 800x600**



conductive castor

swivel with brake

swivel without brake

fixed



| SWIVEL CASTOR WITH BRAKE | Ø mm |
|--------------------------|------|
| C RG DDD11 100 | 100 |

| SWIVEL CASTOR WITHOUT BRAKE | Ø mm |
|-----------------------------|------|
| C RG CDD11 100 | 100 |

| FIXED CASTOR | Ø mm |
|----------------|------|
| C RG BDD11 100 | 100 |

Set of 16 screws to secure the castors to the container.
Ord. no. F PZ 8800 00 00



antistatic material

FEET



Set of 4 feet
Ord. no. F PZ 8752 01 07
Dim. 105x85x112 mm h
Supplied with screws



Central foot on request



The lid allow the containers with four feet and 1 pair of connection pieces to be stacked on top



The lids allow the containers with four feet to be stacked on top

One pair of cross-braces Ord. no. F PZ 8352 01 07 Dim. 800x132x29 mm h



07 BLACK



M15



MEGA-PRINT®
M16

FOF

FOF

MEGA-PRINT®
M16

P.C.B. HANDLING FRAME SYSTEM
MEGA PRINT®
MINIPRINT®





lid
dividers
Megaprint®
Miniprint®
Athena series containers

MEGAPRINT®



MINIPRINT®

A complete range of conductive products has been designed and produced by FAMI, in order to satisfy in a safe and logical manner all the problems of the electronics industry. Simplistic and modular designs characterise the FAMI products in this field, with actual solutions for the productions, storage, transportation, repair or maintenance of P.C.B.'s and various electronic components. For the manufacture of products, FAMI utilize conductive materials of top quality, which offers an ideal and total protection from electrostatic charges or mechanical damage. The FAMI card systems have been found to be ideal used in the sectors of electro/mechanical, electronics, as well as in manufacturing of explosives.

table of SUB-division

In the Megaprint® and Miniprint® systems, the choice of the type of divider is easy and quick by consulting the recommended and quickly if one consults the recommended table of sub-divisions. This determines the insertion point of the divider to the size of the P.C.B. to be inserted.



DiviDeRs

The sub-division of the Megaprint® and Miniprint® system is perfectly adaptable to the wide range of sizes of P.C.B.'s, particularly as the sub-dividers have been designed in three variants. The variants are as follows:

normal distance divider
minus distance divider
plus distance divider

With this system one can vary the distance between dividers by a pitch of 1.7 mm.

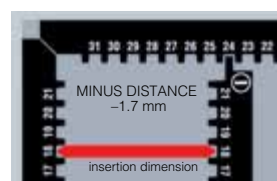
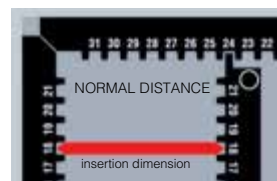
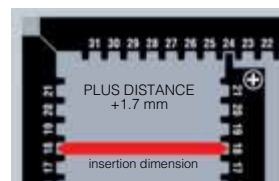

To simplify the insertion of dividers and P.C.B.'s in the Megaprint® and Miniprint® systems, each of the channels are identified numerically. Each channel is referred to by a number which corresponds exactly to the number of the channel opposite.

technical

SPECIFICATIONS



| | |
|------------------------------------|---------|
| WIDTH OF CHANNELS | 2,5 mm |
| DEPTH OF CHANNELS | 3,0 mm |
| PITCH OF CHANNELS | 5,08 mm |
| MINIMUM SUB-DIVISION OF THE SYSTEM | 1,7 mm |

M18

MEGAPRINT® MINIPRINT® 400x300

megaprint® 400x300



The FAMI Megaprint® system 400x300 is reconized as the leader in the field of production and storage of electronic P.C.B.'s. The system itself has been designed and produced to specifically satisfy the work cycle of P.C.B. production, from their design stage to final production. The system is comprised of four rigid walls attached to themselves by reinforced aluminium profiles on their external faces, hence they remains straight and robust. On the internal faces are moulded precision channels which are used to edge locate P.C.B.'s. The design of the system is such that, using the sub-dividers, it can be infinitely adjusted to accomodate P.C.B.'s with a dimension less than 235 mm. The Megaprint® 400x300 is clipped onto the top frame of the 400x300 mm series standard containers.

| | | |
|-----------------------------|------------------------|------------------------|
| ORD. NO. F PV 7752 00 07 | External dimensions mm | Internal dimensions mm |
| | 400x300x140 | 335x235x140 |

| channels | | | minimum sub-division of the system mm | slot pitches |
|----------|----------|----------|---------------------------------------|--------------------|
| width mm | depth mm | pitch mm | | |
| 2,5 | 3,0 | 5,08 | 1,7 | 4 walls of 5,08 mm |

technical specifications of standard system

| | |
|------------------------------------|---------|
| WIDTH OF CHANNELS | 2,5 mm |
| DEPTH OF CHANNELS | 3,0 mm |
| PITCH OF CHANNELS | 5,08 mm |
| MINIMUM SUB-DIVISION OF THE SYSTEM | 1,7 mm |

FITS
container

F PA 4052 A0 07 - F PA 4452 A0 07 - F PA 4852 A0 07 - F PA 5252 A0 07



miniprint® 400x300



The Miniprint® system 400x300 has the same typical characteristics as the Megaprint® system, with the particular characteristic that it can be inserted completely into the conductive FAMI containers of size 400x300 mm and is adapted for the use with P.C.B.'s with a dimension less than 235 mm. For cards which are especially long the Miniprint® system is used in conjunction with the Megaprint® system. The joining of the two systems provides a longer channel, therefore greater security of the inserted P.C.B. is given.

| | | |
|-----------------------------|------------------------|------------------------|
| ORD. NO. F PV 7252 00 07 | External dimensions mm | Internal dimensions mm |
| | 360x260x98 | 335x235x98 |

| channels | | | minimum sub-division of the system mm | slot pitches |
|----------|----------|----------|---------------------------------------|--------------------|
| width mm | depth mm | pitch mm | | |
| 2,5 | 3,0 | 5,08 | 1,7 | 4 walls of 5,08 mm |

technical specifications of standard system

| | |
|------------------------------------|---------|
| WIDTH OF CHANNELS | 2,5 mm |
| DEPTH OF CHANNELS | 3,0 mm |
| PITCH OF CHANNELS | 5,08 mm |
| MINIMUM SUB-DIVISION OF THE SYSTEM | 1,7 mm |

FITS
container

F PA 4052 A0 07 - F PA 4452 A0 07 - F PA 4852 A0 07 - F PA 5252 A0 07





THE USE OF MEGAPRINT® ADDS 44 mm THE CONTAINER HEIGHT OVERALL

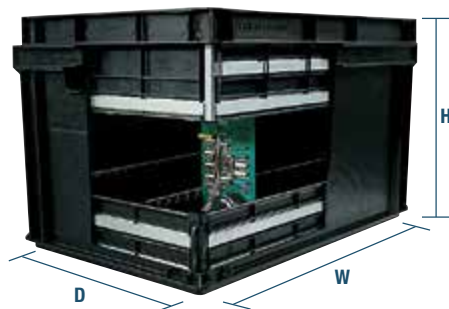

An example of using a Megaprint® in conjunction with a Miniprint® system for P.C.B.'s which are especially long, is shown by using both systems for additional support.

| ORD. NO. | Overall dimensions containers+Megaprint® mm | board capacity | |
|-----------------|------------------------------------------------|----------------|------------|
| | | width (mm) | depth (mm) |
| F PA 4052 A0 07 | 400×300×164 | 235 | 150 |
| F PA 4852 A0 07 | 400×300×264 | 235 | 250 |
| F PA 5252 A0 07 | 400×300×369 | 235 | 355 |

dividers for 400x300

The Megaprint® and Miniprint® systems can be sub-divided in a logical and precise manner using a series of sub-dividers with a special characteristics. These allow the complete and flexible utilization of the system, because any P.C.B., which is smaller than the container itself can be accommodated. The dividers are available with three variants which allow a minimum pitch between sub-dividers of 1.7 mm. The three variants are normal, minus and plus distance. The construction of the dividers is robust and reinforced in profile with aluminium ribs.



| ORD. NO. | distance | divider for mm | external dim. mm |
|-----------------|----------|----------------|------------------|
| F PV 0752 00 07 | minus | 400 | 335×98 |
| F PV 0852 00 07 | normal | 400 | 335×98 |
| F PV 0952 00 07 | plus | 400 | 335×98 |



| ORD. NO. | distance | divider for mm | external dim. mm |
|-----------------|----------|----------------|------------------|
| F PV 0252 00 07 | minus | 300 | 235×98 |
| F PV 0352 00 07 | normal | 300 | 235×98 |
| F PV 0452 00 07 | plus | 300 | 235×98 |

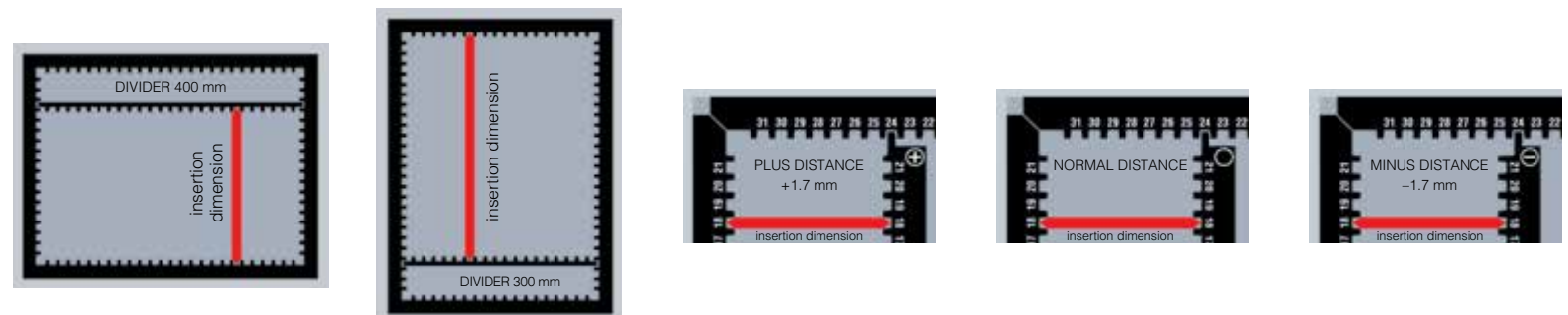

MEGAPRINT® MINIPRINT® 600x400

megaprint® 600x400



The FAMI Megaprint® 600x400 system has technical characteristics equal to the system MP 400x300, and is used with P.C.B.'s with a dimension less than 535 mm. It is insertable in the FAMI conductive container system Athena, with a dimensions of 600x400 mm in various heights.

ORD. NO.
F PV 7952 00 07

External
dimensions mm

600x400x140

Internal
dimensions mm

535x335x140

| width mm | channels | | minimum sub-division of the system mm | slot itches |
|----------|----------|----------|------------------------------------------|--------------------|
| | depth mm | pitch mm | | |
| 2,5 | 3,0 | 5,08 | 1,7 | 4 walls of 5,08 mm |

FITS
container

F PA 6052 A0 07 - F PA 6452 A0 07 - F PB 6852 A0 07 - F PA 7652 A0 07
F PA 8052 B0 07

technical specifications of standard system

| | |
|------------------------------------|---------|
| WIDTH OF CHANNELS | 2,5 mm |
| DEPTH OF CHANNELS | 3,0 mm |
| PITCH OF CHANNELS | 5,08 mm |
| MINIMUM SUB-DIVISION OF THE SYSTEM | 1,7 mm |



miniprint® 600x400



The FAMI Miniprint® 600x400 system has technical characteristics equal to the system MP 400x300, and is used with P.C.B.'s with a dimension less than 535 mm. This system also finds applications using the FAMI conductive container system Athena with dimensions of 600x400 mm with the various heights.

ORD. NO.
F PV 7452 00 07

External
dimensions mm

560x360x98

Internal
dimensions mm

535x335x98

| width mm | channels | | minimum sub-division of the system mm | slot itches |
|----------|----------|----------|------------------------------------------|--------------------|
| | depth mm | pitch mm | | |
| 2,5 | 3,0 | 5,08 | 1,7 | 4 walls of 5,08 mm |

FITS
container

F PA 6052 A0 07 - F PA 6452 A0 07 - F PB 6852 A0 07 - F PA 7652 A0 07
F PA 8052 B0 07

technical specifications of standard system

| | |
|------------------------------------|---------|
| WIDTH OF CHANNELS | 2,5 mm |
| DEPTH OF CHANNELS | 3,0 mm |
| PITCH OF CHANNELS | 5,08 mm |
| MINIMUM SUB-DIVISION OF THE SYSTEM | 1,7 mm |





THE USE OF MEGAPRINT® ADDS 44 mm THE CONTAINER HEIGHT OVERALL

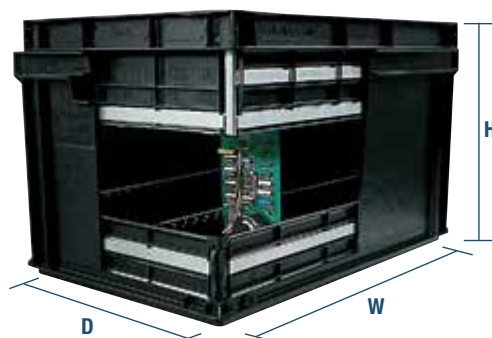

An example of using a Megaprint® in conjunction with a Miniprint® system for P.C.B.'s which are especially long, is shown by using both systems for additional support.

| ORD. NO. | Overall dimensions containers+Megaprint® mm | board capacity | |
|-----------------|------------------------------------------------|----------------|------------|
| | | width (mm) | depth (mm) |
| F PB 6852 A0 07 | 600×400×264 | 535 | 250 |
| F PA 7652 A0 07 | 600×400×369 | 535 | 355 |
| F PA 8052 B0 07 | 600×400×474 | 535 | 455 |

dividers for 600×400

The Megaprint® and Miniprint® systems can be sub-divided in a logical and precise manner using a series of sub-dividers with a special characteristics. These allow the complete and flexible utilization of the system, because any P.C.B., which is smaller than the container itself can be accommodated. The dividers are available with three variants which allow a minimum pitch between sub-dividers of 1.7 mm. The three variants are normal, minus and plus distance. The construction of the dividers is robust and reinforced in profile with aluminium ribs.



| ORD. NO. | distance | divider for mm | external dim. mm | ORD. NO. | distance | divider for mm | external dim. mm |
|-----------------|----------|----------------|------------------|-----------------|----------|----------------|------------------|
| F PV 0752 00 07 | minus | 400 | 335×98 | F PV 1752 00 07 | minus | 600 | 535×98 |
| F PV 0852 00 07 | normal | 400 | 335×98 | F PV 1852 00 07 | normal | 600 | 535×98 |
| F PV 0952 00 07 | plus | 400 | 335×98 | F PV 1952 00 07 | plus | 600 | 535×98 |

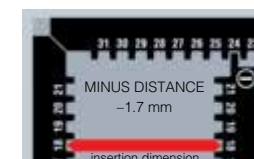
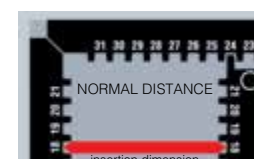
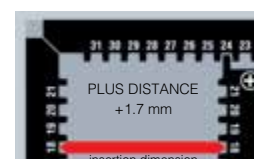
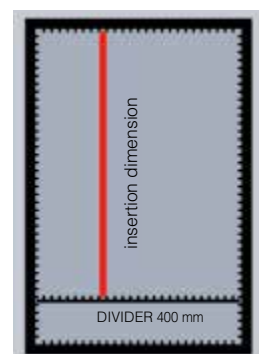
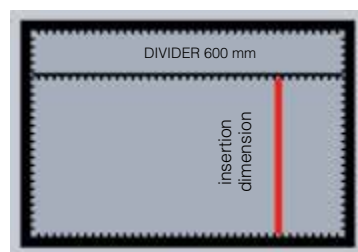

CARD CARRYING SYSTEM



M23



The card carrying frames make up an integral part of the FAMI P.C.B. carrying systems, and are used in the production, storage and transportation of P.C.B.'s. They are formed essentially of two lateral walls and a central fixed wall between them and aluminium guides. These frames can be used either inserted in the containers or else as a totally independant system. Apart from the standardized container insertion dimensions, the system can give the possibility, dependant upon the length of the guides, to have more variable measurements. The frame can be used in a vertical, horizontal or flat position, and they can be stacked providing they are of equal dimensions. Also if the frame is compatible, the precision of the solution is such as to permit the use in either manual or robotic application.

Our Card carries provide an excellent edge mounting system for handling circuit boards. Made from injection moulded conductive co-polymer polypropylene with electrical value of 104Ω/l, they can be used in contact with the majority of solvents and to a temperature 100 °C. The unique flexibility of the clamping system, allow the re-inforced card guides to move over the entire length of the side aluminium guide rails.

pair of aluminium **GUIDES**

| ORD. NO. | Dim. mm | ORD. NO. | Dim. mm | ORD. NO. | Dim. mm | ORD. NO. | Dim. mm |
|-----------------|---------|-----------------|---------|-----------------|---------|-----------------|---------|
| F PV 9110 00 00 | 152x53 | F PV 9120 00 00 | 252x53 | F PV 9140 00 00 | 352x53 | F PV 9160 00 00 | 552x53 |



Frame complete with fasteners



| ORD. NO. F PV 6452 00 07 | | channels | | | |
|--------------------------|--------|----------|-------|-------|--|
| side frames | | width | depth | pitch | |
| Dim. mm | number | mm | mm | mm | |
| 350x30x190 | 22 | 2,5 | 3,0 | 15,03 | |



| ORD. NO. F PV 6852 00 07 | | channels | | | |
|--------------------------|--------|----------|-------|-------|--|
| central frames | | width | depth | pitch | |
| Dim. mm | number | mm | mm | mm | |
| 350x35x190 | 22+22 | 2,5 | 3,0 | 15,03 | |



| ORD. NO. F PV 6252 00 07 | | channels | | | |
|--------------------------|--------|----------|-------|-------|--|
| side frames | | width | depth | pitch | |
| Dim. mm | number | mm | mm | mm | |
| 250x30x95 | 15 | 2,5 | 3,0 | 15,03 | |

fastener complete of

SCREW AND NUT

Ord. No. F PV 9010 00 07

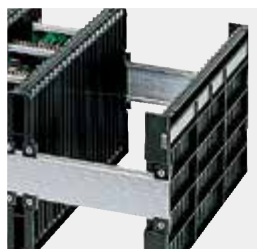

side frames



fastener



fitting the frame



shifting the central divider

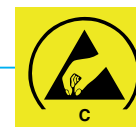

F PV 9110 01 00, F PV 9140 01 00, F PV 9120 01 00 e F PV 9160 01 00

All card guides have as standard a re-inforcing aluminium rail for extra rigidity. **The slot profile in the card guides is 2.5 mm wide and 3.0 mm deep on a 15.3 mm pitch.** Each card guide also has a moulded in slot numbering system, to ensure correct location of cards, and an integral base stop. **All components can be purchased separately and the aluminium rails can be supplied in lengths up to 1.5 m to provide flexibility in designing a system to suit your manufacturing requirements.**

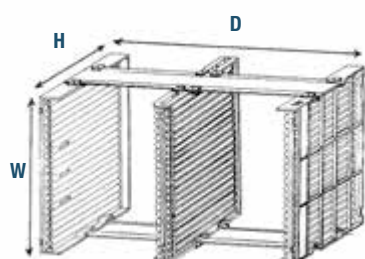
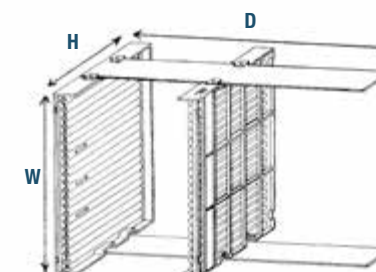

F PV 9120 02 00 e F PV 9160 02 00

This system provides the same low cost solutions as the models F PV 9110 01 00, F PV 9140 01 00, F PV 9120 01 00 and F PV 9160 01 00 **but has the double-sided centre card guide incorporated. Since the centre panel (Order no. F PV 6852 00 07) is double-sided, it allows for extra capacity without the loss of space associated with other systems which need to use two single card guides to achieve the same result.** Standard Conductive Container's for storage of these card carriers are available in varying depths to suit different models of carrier.

| ORD. NO. | overall Dim. mm | p.c.b. capacity maximum mm | p.c.b. slot | fits into container | utilized standard Fami | |
|------------------------|-----------------|----------------------------|-------------|-------------------------------------------------------|------------------------------------------|------------------------------|
| | | | | | p.c.b. card | guide rails |
| F PV 9110 01 00 | 152x250x95 | 135x105 | 15 | F PA 2452 A0 07 | 2x F PV 6252 00 07 | 1x F PV 9110 00 00 152 mm |
| F PV 9140 01 00 | 352x250x95 | 335x150 | 15 | F PA 4052 A0 07 F PA 4452 A0 07 | 2x F PV 6252 00 07 | 1x F PV 9140 00 00 352 mm |
| F PV 9120 01 00 | 252x350x190 | 235x300 | 21 | F PA 4852 A0 07 F PA 5252 A0 07 | 2x F PV 6452 00 07 | 1x F PV 9120 00 00 252 mm |
| F PV 9160 01 00 | 552x350x190 | 535x400 | 21 | F PB 6852 A0 07 F PA 7652 A0 07 F PA 8052 B0 07 | 2x F PV 6452 00 07 | 1x F PV 9160 00 00 552 mm |
| F PV 9120 02 00 | 252x350x190 | 95x300 | 42 | F PA 4852 A0 07 F PA 5252 A0 07 | 2x F PV 6452 00 07 1x F PV 6852 00 07 | 1x F PV 9120 00 00 252 mm |
| F PV 9160 02 00 | 552x350x190 | 254x400 | 42 | F PB 6852 A0 07 F PA 7652 A0 07 F PA 8052 B0 07 | 2x F PV 6452 00 07 1x F PV 6852 00 07 | 1x F PV 9160 00 00 552 mm |

The card carrying frames used in conjunction with ATHENA conductive containers, 600x400 and 400x300 mm.

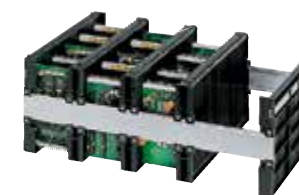
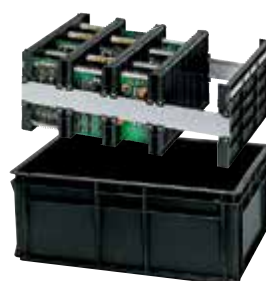

frame in a **horizontal** position

frame in a **vertical** position

frame in a **flat** position

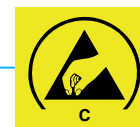

The new FAMI circuit board holder has been so **designed that it allows completely universal usage**. The grid style slot arrangement ensures the best possible utilization of available space. The circuit board holder has been sized to fit securely into the base of a standard 400x300 mm Euro-container. **The spacing of the dimples on a grid pattern will allow for use with all P.C.B's** up to a maximum thickness of 2 mm.



| ORD. NO. | Dim. mm |
|-----------------|--------------|
| F PV 5752 00 07 | 355x255x14 h |



07 BLACK



CONDUCTIVE STORAGE CONTAINERS SERIES

ZELUS COMPAT

CONDUCTIVE

MULTIBOX BOXES

CONDUCTIVE FLOORING

MATS



conductive storage containers

The FAMI Conductive Plastic Picking Bins come complete with all of the standard designs and features universally accepted with this most versatile electronics industry container. The accepted standard features include fitting onto louvre panel racks as well as self stacking upon each other. The half open sloping front wall of the container makes for easy of component picking. An added feature of the FAMI range, is that the two smallest size bins actually "Lock into" each other and hence save the requirement for a louvre panel in the smaller work stations. Manufactured from conductive Copolymer Polypropylene these containers supply full ESD protection to valuable electronics components.

conductive multibox boxes

The Multibox Series F PK boxes are manufactured in four different sizes and are available in black conductive polypropylene for the storage of sensitive electronic components.

They are injection molded in a special conductive compound "FAMI 08 L" which has the characteristics to impede the formation of electrostatic charges or to discharge any charges already present. The boxes are only available in a standard width of 160 mm and a height of 100 mm, but in 4 different depths: 300, 400, 500 and 650 mm. The design allows for the length of the box to be subdivided by removable partitions up to a maximum of 11 cells. The boxes can be fitted with a handle which can provide a multitude of tasks. 1. Manual carrying. 2. Manual withdrawing from storage shelves. 3. Prevention of boxes falling out shelves when partially withdrawn. The box front and partitions have space provided for the fitting of identification labels.

***** Partitions, handles and labels must all be ordered as separate item.**

special conductive plastic FAMI 408 L particularly suitable for the electronics industry

technical

SPECIFICATIONS

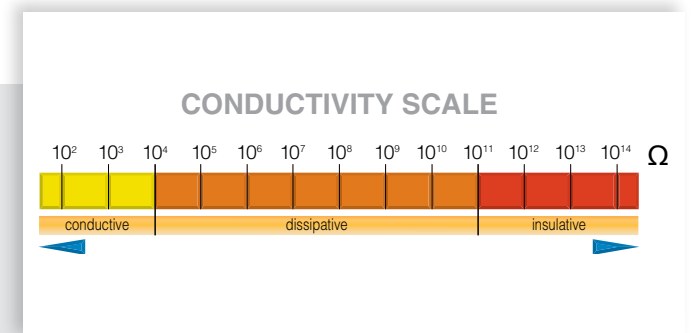

| | |
|-----------------------|--------------------------------------------------------------------------------------------------------------------------|
| BASE MATERIAL | Polypropylene copolymer (PPC) |
| CONDUCTIVITY ADDITIVE | Carbon black |
| COLOUR | Black |
| DENSITY, AT 23°C | 1.04 g/cm ³ |
| VICAT SOFTENING POINT | 154° C ISO 306 |
| WORKING TEMPERATURE | Continuous: approx 80-100°C Short term: approx 100-120°C |
| SURFACE RESISTANCE | less than 10 ⁴ Ω cm (measured according to CEI EN 61340-2-3 at 20°C with a 5 cm ² ring electrode). |
| VOLUME RESISTIVITY | 10 ⁴ Ω cm (measured according to CEI EN 61340-2-3 at 20°C with a 5 cm ² ring electrode). |
| AGEING BEHAVIOUR | No deterioration of conductivity (in 7 years of service), no leaching of corrosive substances, excellent UV resistance. |
| CHEMICAL RESISTANCE | Excellent (according to the generally valid PP classification). |

ZEUS COMPAT



stacking containers series Zeus

| container ORD. NO. | A | B | C | D | E | F | G | H | I | L |
|------------------------|-----|-----|-----|-----|-----|-----|-----|-----|-----|-----|
| F PJ 2552 00 07 | 211 | 178 | 191 | 201 | 109 | 122 | 148 | 129 | 126 | 140 |
| F PJ 3352 00 07 | 312 | 255 | 283 | 303 | 130 | 144 | 209 | 184 | 182 | 201 |
| F PJ 5752 00 07 | 465 | 425 | 425 | 455 | 105 | 120 | 314 | 277 | 275 | 305 |
| F PJ 6552 00 07 | 464 | 403 | 425 | 453 | 181 | 198 | 313 | 281 | 276 | 302 |

storage containers serie Compat

| container ORD. NO. | A | B | C | D | E | F | G | H | I | L | M | N |
|------------------------|-----|-----|-----|-----|-----|-----|-----|-----|-----|-----|-----|-----|
| F PM 1752 00 07 | 168 | 133 | 133 | 136 | 66 | 75 | 102 | 88 | 87 | 96 | 35 | 33 |
| F PM 2552 00 07 | 236 | 193 | 193 | 202 | 110 | 122 | 150 | 128 | 126 | 141 | 61 | 52 |
| F PM 3352 00 07 | 342 | 273 | 285 | 296 | 130 | 143 | 208 | 186 | 183 | 201 | 71 | 61 |
| F PM 4152 00 07 | 347 | 270 | 279 | 291 | 185 | 200 | 209 | 181 | 179 | 201 | 99 | 90 |
| F PM 5752 00 07 | 499 | 428 | 441 | 450 | 129 | 143 | 311 | 284 | 281 | 301 | 73 | 61 |
| F PM 6552 00 07 | 502 | 426 | 436 | 445 | 185 | 200 | 313 | 285 | 282 | 303 | 100 | 90 |
| F PM 7352 00 07 | 503 | 423 | 435 | 445 | 285 | 302 | 313 | 285 | 280 | 303 | 151 | 140 |

storage containers series Zeus

| container ORD. NO. | A | B | C | D | E | F | G | H | I | L | M | N |
|------------------------|----|----|----|----|----|----|-----|----|----|----|----|----|
| F PL 0952 00 07 | 93 | 63 | 63 | 68 | 44 | 52 | 103 | 92 | 91 | 99 | 26 | 21 |

The technical data contained in the above tables is approximate. FAMI S.r.l. reserves the right to make any modifications it sees fit to improve the performance and appearance of products. The manufacturer is not liable for any printing errors.

stacking containers zeus

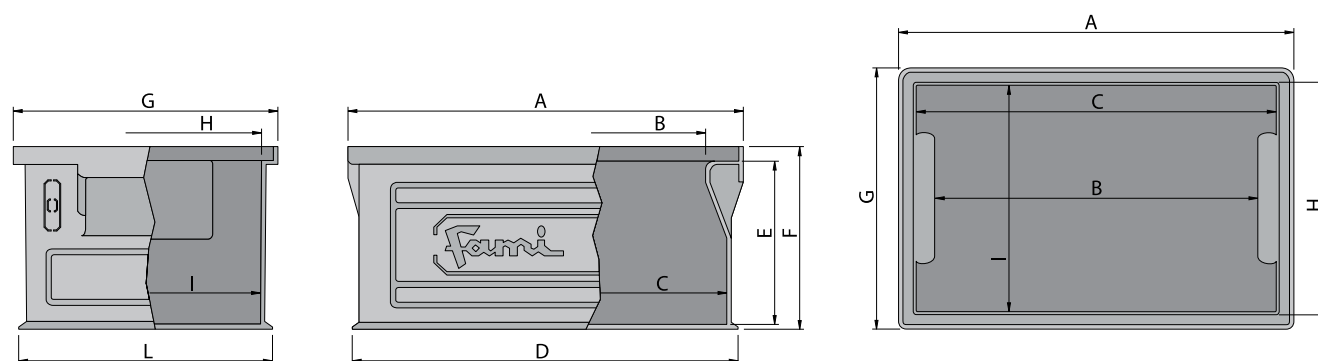

ACCESSORIES
PAGE
M32



series compat

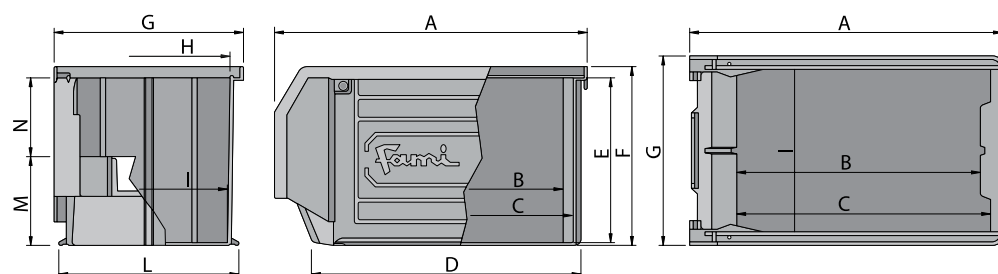

series zeus

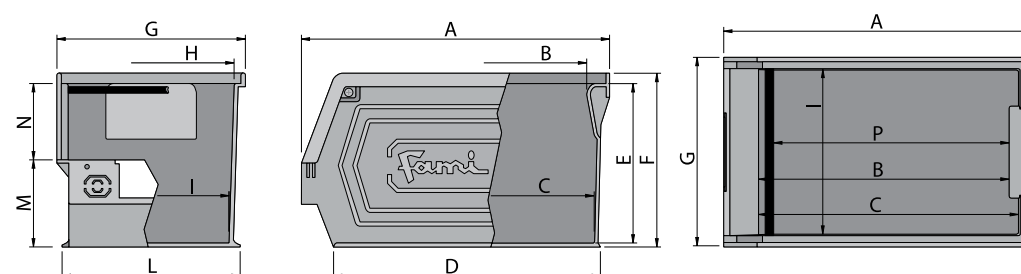

M29

Stacking containers series Zeus



SOLID BOTTOM



ORD. NO. F PJ 2552 00 07 -single

Measurements: EL272-2PL

Standard colour: 07 black ■

Batch of: 54 pcs.

Weight gr.: 306

External nominal dim. mm: 200×140×130 h

Internal nominal dim. mm: 191×126×109 h

ORD. NO. FYJ 2552 00 07 -pallet

Weight of pallet kg: 273

Qty. Containers per pallet: 810 pcs.

Shipping dimensions mm: 1400×1100×1660 h



SOLID BOTTOM



ORD. NO. F PJ 3352 00 07 -single

Measurements: EL272-3A2PL

Standard colour: 07 black ■

Batch of: 21 pcs.

Weight gr.: 582

External nominal dim. mm: 300×200×145 h

Internal nominal dim. mm: 283×182×130 h

ORD. NO. FYJ 3352 00 07 -pallet

Weight of pallet kg: 178

Qty. Containers per pallet: 252 pcs.

Shipping dimensions mm: 1350×1000×2000 h



SOLID BOTTOM

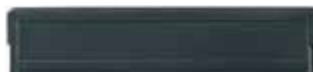

ORD. NO. F PJ 5752 00 07 -single

Measurements: EL272-4A2PL

Standard colour: 07 black ■

Batch of: 16 pcs.

Weight gr.: 1084

External nominal dim. mm: 450×300×120 h

Internal nominal dim. mm: 425×275×105 h

ORD. NO. FYJ 5752 00 07 -pallet

Weight of pallet kg: 151

Qty. Containers per pallet: 128 pcs.

Shipping dimensions mm: 1300×1000×1900 h



SOLID BOTTOM



ORD. NO. F PJ 6552 00 07 -single

Measurements: EL272-4PL

Standard colour: 07 black ■

Batch of: 10 pcs.

Weight gr.: 1526

External nominal dim. mm: 450×300×200 h

Internal nominal dim. mm: 425×276×181 h

ORD. NO. FYJ 6552 00 07 -pallet

Weight of pallet kg: 134

Qty. Containers per pallet: 80 pcs.

Shipping dimensions mm: 1300×1000×2000 h

Storage containers series Zeus



SOLID BOTTOM



ORD. NO. F PL 0952 00 07 -single

Measurements: EL0PL-Z

Standard colour: 07 black ■

Batch of: 50 pcs.

Weight gr.: 48

External nominal dim. mm: 85/65×95×45 h

Internal nominal dim. mm: 63×91×44 h



ORD. NO. F PM 1752 00 07 -single

| | |
|------------------|------------|
| Measurements: | EL1PL-C |
| Standard colour: | 07 black ■ |
| Batch of: | 50 pcs. |

| | |
|---------------------------|-----------------|
| Weight gr.: | 90 |
| External nominal dim. mm: | 160/140×95×75 h |
| Internal nominal dim. mm: | 133×87×66 h |

ORD. NO. F YM 1752 00 07 -pallet

| | |
|-----------------------------|------------------|
| Weight of pallet kg: | 188 |
| Qty. Containers per pallet: | 1750 pcs. |
| Shipping dimensions mm: | 1300×1100×2000 h |

SOLID BOTTOM



ORD. NO. F PM 2552 00 07 -single

| | |
|------------------|------------|
| Measurements: | EL2PL-C |
| Standard colour: | 07 black ■ |
| Batch of: | 54 pcs. |

| | |
|---------------------------|-------------------|
| Weight gr.: | 248 |
| External nominal dim. mm: | 230/200×140×130 h |
| Internal nominal dim. mm: | 193×126×110 h |

ORD. NO. F YM 2552 00 07 -pallet

| | |
|-----------------------------|------------------|
| Weight of pallet kg: | 302 |
| Qty. Containers per pallet: | 1080 pcs. |
| Shipping dimensions mm: | 1450×1200×2100 h |

SOLID BOTTOM



ORD. NO. F PM 3352 00 07 -single

| | |
|------------------|------------|
| Measurements: | EL3A2PL-C |
| Standard colour: | 07 black ■ |
| Batch of: | 21 pcs. |

| | |
|---------------------------|-------------------|
| Weight gr.: | 678 |
| External nominal dim. mm: | 350/300×200×145 h |
| Internal nominal dim. mm: | 273×183×130 h |

ORD. NO. F YM 3352 00 07 -pallet

| | |
|-----------------------------|------------------|
| Weight of pallet kg: | 203 |
| Qty. Containers per pallet: | 252 pcs. |
| Shipping dimensions mm: | 1400×1100×2000 h |

SOLID BOTTOM



ORD. NO. F PM 4152 00 07 -single

| | |
|------------------|------------|
| Measurements: | EL3PL-C |
| Standard colour: | 07 black ■ |
| Batch of: | 15 pcs. |

| | |
|---------------------------|-------------------|
| Weight gr.: | 848 |
| External nominal dim. mm: | 350/300×200×200 h |
| Internal nominal dim. mm: | 270×179×185 h |

ORD. NO. F YM 4152 00 07 -pallet

| | |
|-----------------------------|------------------|
| Weight of pallet kg: | 185 |
| Qty. Containers per pallet: | 180 pcs. |
| Shipping dimensions mm: | 1400×1100×2000 h |

SOLID BOTTOM



ORD. NO. F PM 5752 00 07 -single

| | |
|------------------|------------|
| Measurements: | EL4A2PL-C |
| Standard colour: | 07 black ■ |
| Batch of: | 14 pcs. |

| | |
|---------------------------|-------------------|
| Weight gr.: | 1374 |
| External nominal dim. mm: | 500/450×300×145 h |
| Internal nominal dim. mm: | 428×281×129 h |

ORD. NO. F YM 5752 00 07 -pallet

| | |
|-----------------------------|------------------|
| Weight of pallet kg: | 166 |
| Qty. Containers per pallet: | 112 pcs. |
| Shipping dimensions mm: | 1300×1000×2000 h |

SOLID BOTTOM



ORD. NO. F PM 6552 00 07 -single

| | |
|------------------|------------|
| Measurements: | EL4PL-C |
| Standard colour: | 07 black ■ |
| Batch of: | 10 pcs. |

| | |
|---------------------------|-------------------|
| Weight gr.: | 1534 |
| External nominal dim. mm: | 500/450×300×200 h |
| Internal nominal dim. mm: | 426×282×185 h |

ORD. NO. F YM 6552 00 07 -pallet

| | |
|-----------------------------|------------------|
| Weight of pallet kg: | 148 |
| Qty. Containers per pallet: | 80 pcs. |
| Shipping dimensions mm: | 1300×1000×2000 h |

SOLID BOTTOM



Storage containers series **Compat**



SOLID BOTTOM



ORD. NO. F PM 7352 00 07 -single

Measurements: EL4A5PL-C

Standard colour: 07 black ■

Weight gr.: 2374

External nominal dim. mm: 500/450×300×300 h

Internal nominal dim. mm: 423×280×285 h

ORD. NO. FYM 7352 00 07 -pallet

Weight of pallet kg: 145

Qty. Containers per pallet: 56 pcs.

Shipping dimensions mm: 1300×1000×2150 h



LABELS

SPECIAL LABELS

Page Q1



stacking containers

| label sheet | for stacking container ORD. NO. | size of label | number of labels per sheet |
|-----------------|---------------------------------|---------------|----------------------------|
| F PL 9140 00 00 | F PJ 5752 00 07 | 189×82 | 3 |
| F PL 9160 00 00 | F PJ 6552 00 07 | 189×85 | 3 |

The technical data contained in the above table is approximate. FAMI S.r.l. reserves the right to make any modifications it sees fit to improve the performance and appearance of products. The manufacturer is not liable for any printing errors.

storage containers

| label sheet | for storage container ORD. NO. | size of label | number of labels per sheet |
|-----------------|-------------------------------------------------------|---------------|----------------------------|
| F PL 9020 00 00 | F PL 0952 00 07 | 49×11 | 80 |
| F PL 9040 00 00 | F PM 1752 00 07 | 75×20 | 36 |
| F PL 9100 00 00 | F PM 2552 00 07 | 104×33 | 16 |
| F PL 9060 00 00 | F PM 3352 00 07 F PM 5752 00 07 | 77×31 | 18 |
| F PL 9080 00 00 | F PM 4152 00 07 F PM 6552 00 07 F PM 7352 00 07 | 77×42 | 12 |

The technical data contained in the above table is approximate. FAMI S.r.l. reserves the right to make any modifications it sees fit to improve the performance and appearance of products. The manufacturer is not liable for any printing errors.

MULTIBOX

07 BLACK

| container ORD. NO. | A | B | C | D | E | F | G | G1 | H | I | L |
|--------------------|-----|-----|-----|-----|----|-----|-----|-----|-----|-----|-----|
| F PK 1052 00 07 | 301 | 264 | 258 | 268 | 88 | 100 | 161 | 163 | 139 | 136 | 151 |
| F PK 2052 00 07 | 401 | 365 | 358 | 368 | 89 | 100 | 160 | 163 | 138 | 136 | 151 |
| F PK 3552 00 07 | 502 | 465 | 457 | 468 | 89 | 100 | 161 | 163 | 138 | 136 | 151 |
| F PK 5052 00 07 | 655 | 618 | 613 | 621 | 88 | 101 | 161 | 163 | 138 | 136 | 151 |

The technical data contained in the above table is approximate. FAMI S.r.l. reserves the right to make any modifications it sees fit to improve the performance and appearance of products. The manufacturer is not liable for any printing errors.

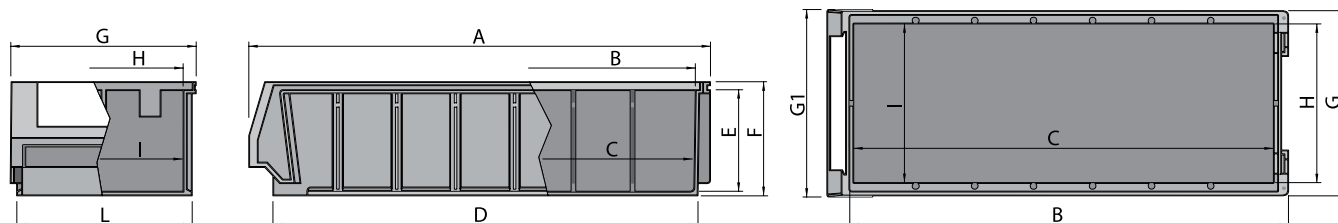

Detail of
SOLID
BOTTOM



M33



SOLID BOTTOM

ORD. NO. F PK 1052 00 07 -single

| | |
|------------------|------------|
| Measurements: | ELRK3016 |
| Standard colour: | 07 black ■ |
| Batch of: | 24 pcs. |

| | |
|---------------------------|---------------|
| Weight gr.: | 438 |
| External nominal dim. mm: | 300×160×100 h |
| Internal nominal dim. mm: | 258×136×88 h |

ORD. NO. F YK 1052 00 07 -pallet

| | |
|-----------------------------|------------------|
| Weight of pallet kg: | 192 |
| Qty. Containers per pallet: | 384 pcs. |
| Shipping dimensions mm: | 1300×1000×1700 h |



SOLID BOTTOM

ORD. NO. F PK 2052 00 07 -single

| | |
|------------------|------------|
| Measurements: | ELRK4016 |
| Standard colour: | 07 black ■ |
| Batch of: | 24 pcs. |

| | |
|---------------------------|---------------|
| Weight gr.: | 516 |
| External nominal dim. mm: | 400×160×100 h |
| Internal nominal dim. mm: | 358×136×89 h |

ORD. NO. F YK 2052 00 07 -pallet

| | |
|-----------------------------|------------------|
| Weight of pallet kg: | 172 |
| Qty. Containers per pallet: | 288 pcs. |
| Shipping dimensions mm: | 1300×1000×1700 h |



SOLID BOTTOM

ORD. NO. F PK 3552 00 07 -single

| | |
|------------------|------------|
| Measurements: | ELRK5016 |
| Standard colour: | 07 black ■ |
| Batch of: | 24 pcs. |

| | |
|---------------------------|---------------|
| Weight gr.: | 648 |
| External nominal dim. mm: | 500×160×100 h |
| Internal nominal dim. mm: | 457×136×89 h |

ORD. NO. F YK 3552 00 07 -pallet

| | |
|-----------------------------|------------------|
| Weight of pallet kg: | 144 |
| Qty. Containers per pallet: | 192 pcs. |
| Shipping dimensions mm: | 1050×1000×1700 h |



SOLID BOTTOM

ORD. NO. F PK 5052 00 07 -single

| | |
|------------------|------------|
| Measurements: | ELRK6516 |
| Standard colour: | 07 black ■ |
| Batch of: | 24 pcs. |

| | |
|---------------------------|---------------|
| Weight gr.: | 816 |
| External nominal dim. mm: | 650×160×100 h |
| Internal nominal dim. mm: | 613×136×88 h |

ORD. NO. F YK 5052 00 07 -pallet

| | |
|-----------------------------|------------------|
| Weight of pallet kg: | 180 |
| Qty. Containers per pallet: | 192 pcs. |
| Shipping dimensions mm: | 1300×1000×1700 h |



| ORD. NO. | DIM. mm |
|-----------------|----------|
| F PK 6352 00 07 | 120×80 h |

For ORD. NO. F PK 1052 00 07 - F PK 2052 00 07 - F PK 3552 00 07 - F PK 5052 00 07

| ORD. NO. | DIM. mm |
|-----------------|----------|
| F PK 7352 00 07 | 145×90 h |

For ORD. NO. F PK 1052 00 07 - F PK 2052 00 07 - F PK 3552 00 07 - F PK 5052 00 07

labels for BOXES

| label sheet | size of label | number of labels per sheet |
|-----------------|---------------|----------------------------|
| F PK 9580 00 00 | 121×44 | 8 |

For ORD. NO. F PK 1052 00 07 - F PK 2052 00 07 - F PK 3552 00 07 - F PK 5052 00 07

labels for DIVIDERS

| label sheet | size of label | number of labels per sheet |
|-----------------|---------------|----------------------------|
| F PK 9560 00 00 | 121×24 | 16 |

For ORD. NO. F PK 7352 00 07



CONDUCTIVE FLOORING MATS

CLOSED
TOP VERSION



SPECIAL FEATURES

anti slip
CONDUCTIVE
easily cleaned
SOFT
sound absorbing

| ORD. NO. | DIM. mm | description |
|-----------------|------------|--------------|
| F PX 1542 00 07 | 800x400x25 | mat |
| F PX 0242 00 07 | 400x120x25 | edge strip |
| F PX 0742 00 07 | 120x120x25 | corner piece |

The special joining system of parts allows for easy assembly, to facilitate routine cleaning and maintenance programmes. These mats are particularly suitable to the electronics as well as the explosive manufacturing industries. The material used is a conductive low density polyethylene.

07 BLACK





NON-SIP MATTING



EXCELLENT ADHERENCE TO THE FLOOR



This matting is used in workshops, metal working industries, laundrettes, the food industry, stores, public swimming pools, camp-sites and changing rooms, etc.. Summary of the test report issued by the Plastics Centre for southern Germany have given the following synthetic results: The matting adheres well to the floor both when “loaded” and “unloaded”: they have no edges (on which people could trip) or large gaps. Furthermore, with a rugged surface, they provide excellent traction in wet or humid conditions.

RESISTANT

The special structure of the matting is designed to withstand heavy loads.

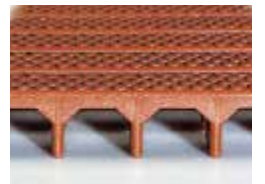

ANTI-SLIP

The special relief pattern on the surface guarantees maximum adherence, even in wet conditions.



ELECTRICAL CABLES

The non-slip matting can cover electrical cables running along the floor in perfect safety.



SAFETY

Connection clamps and chamfered corner pieces increase operator safety, trolley wheels run smoothly over the mat and improve the appearance of the matting.



CONNECTION SYSTEM

All the parts can be fitted together and removed thanks to a special connection system.



solid non-slip matting



grey

brick red

| ORD. NO. | DIM. mm | ORD. NO. | DIM. mm |
|-----------------|--------------|-----------------|--------------|
| F PX 1541 00 01 | 800x400x25 h | F PX 1541 00 06 | 800x400x25 h |

01 GREY
06 BRICK RED

perforated non-slip matting



grey

brick red

| ORD. NO. | DIM. mm | ORD. NO. | DIM. mm |
|-----------------|--------------|-----------------|--------------|
| F PX 2541 00 01 | 800x400x25 h | F PX 2541 00 06 | 800x400x25 h |

01 GREY
06 BRICK RED

N3

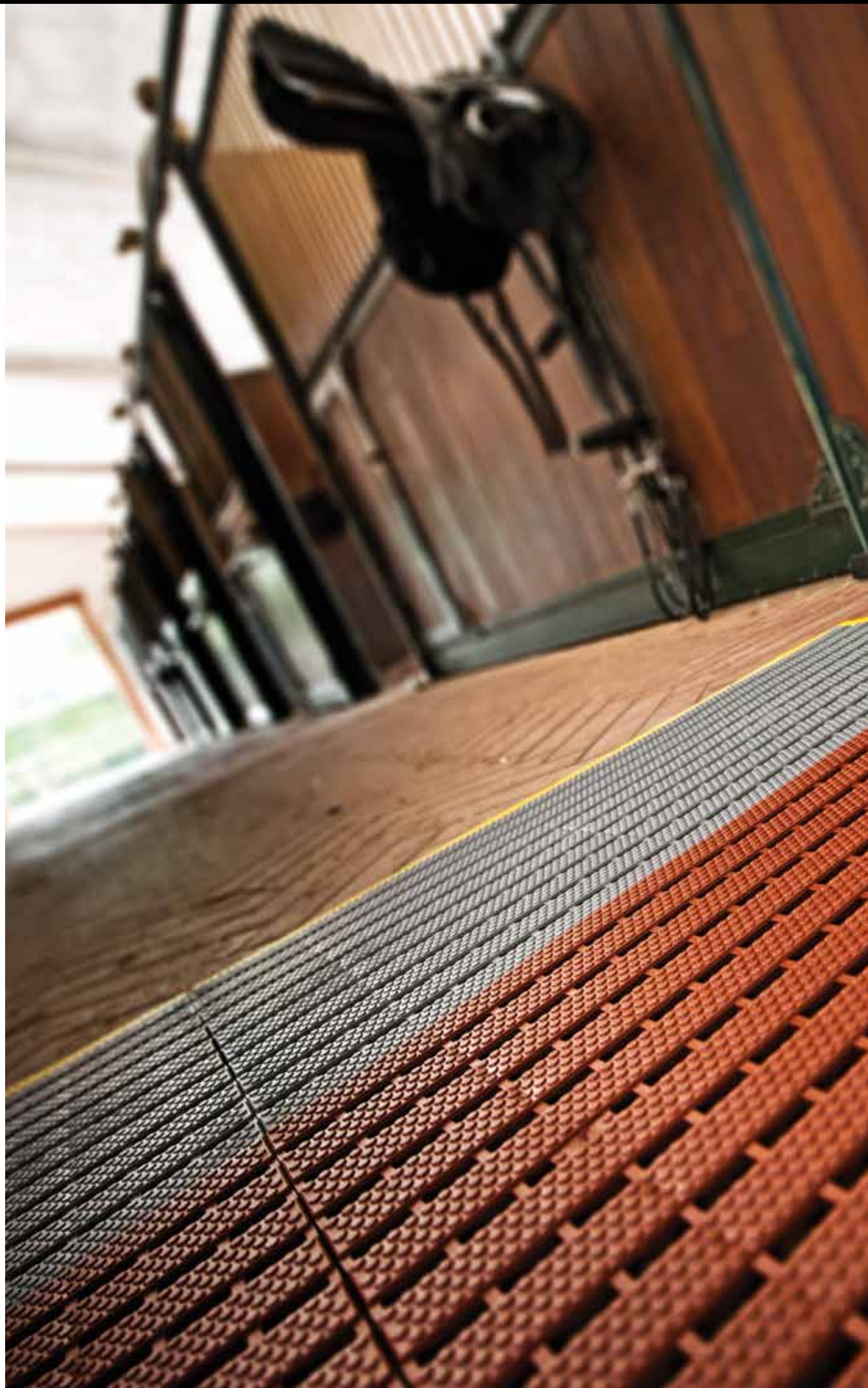



EDGING PIECE



| ORD. NO. | DIM. mm |
|-----------------|---------|
| F PX 0241 00 05 | 400x120 |

corner piece



| ORD. NO. | DIM. mm |
|-----------------|---------|
| F PX 0741 00 05 | 120x120 |

05 YELLOW

galvanised clips



| ORD. NO. | DIM. mm |
|-----------------|---------|
| F PX 0910 00 99 | 120x120 |

99 GALVANISED

FOOD-APPROVED
C STACKING
CONTAINERS





series

page O5

aTHENA



series

page O7

THEma



series

page O9

minERVA



STACKING CONTAINERS SERIES

ATHENA
THEMA
MINERVA



The storage of food is critical because, in addition to guaranteeing perfect hygiene of the food itself, the storage systems must meet specific food grade certifications and consumer choice.





Boxes are manufactured in **Food-APPROVATED PLASTIC** compliant with:

- Italian Ministerial decree of 21 March 1973 and subsequent amendments and additions: Health regulations for packaging, receptacles and utensils intended to come into contact with foodstuffs or personal care products.
- Italian Presidential Decree no. 777 of 23 August 1982 and subsequent amendments and additions: Implementing Directive 76/893/EEC relating to materials and articles intended to come into contact with foodstuffs.
- Regulation (EC) no. 1935/2004 of the European Parliament and of the Council of 27 October 2004 on materials and articles intended to come into contact with food and repealing Directives 80/590/EEC and 89/109/EEC.
- Commission Regulation (EC) no. 1895/2005 of 18 November 2005 on the restriction of use of certain epoxy derivatives in materials and articles intended to come into contact with food.
- Commission Regulation (EC) No. 2023/2006 of 22 December 2006 on good manufacturing practice for materials and articles intended to come into contact with food.
- Commission Regulation (EU) No. 10/2011 of 14 January 2011 on plastic materials and articles intended to come into contact with food (replacing and repealing Directive 2002/72/EC).



ATHENA

Made of **food grade polypropylene**, Series **Athena**, **Minerva** and **Thema** containers are the ideal solution for transporting and storage of **food products**. They are available **with cover**.



| container ORD. NO. | A | B | C | D | E | F | G | H | I | L | M |
|------------------------|-----|-----|-----|-----|-----|-----|-----|-----|-----|-----|-----|
| F PA 4859 A0 00 | 401 | 370 | 358 | 367 | 202 | 221 | 301 | 270 | 258 | 266 | |
| F PA 5659 A0 00 | 602 | 567 | 555 | 563 | 58 | 76 | 404 | 367 | 355 | 363 | 607 |
| F PA 6059 A0 00 | 602 | 570 | 558 | 566 | 102 | 120 | 402 | 369 | 357 | 366 | 601 |
| F PA 7659 A0 00 | 602 | 571 | 558 | 567 | 307 | 326 | 402 | 370 | 357 | 366 | 603 |

A0 The technical data contained in the above table is approximate. FAMI S.r.l. reserves the right to make any modifications it sees fit to improve the performance and appearance of products. The manufacturer is not liable for any printing errors.

Fami S.r.l. declares that the boxes are suitable for contact with all types of food.

The Declaration of Conformity will be provided on request.

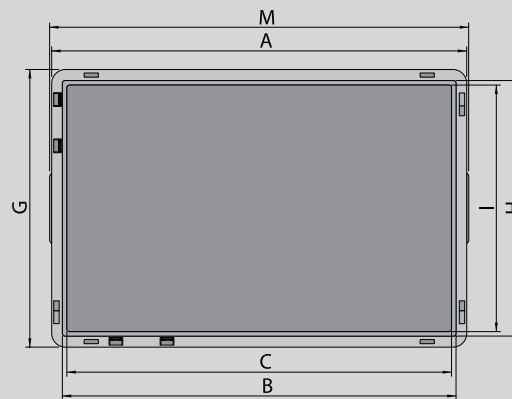
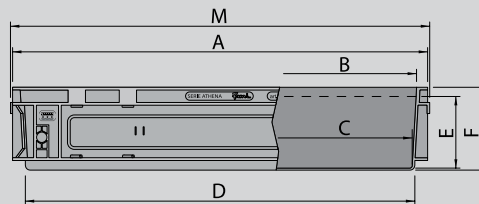
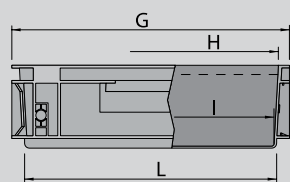

Detail of
**SOLID
BOTTOM**





SOLID BOTTOM

ORD. NO. F PA 4859 A0 00 -single

| | |
|------------------|------------|
| Measurements: | 4322A |
| Standard colour: | colourless |

| | |
|---------------------------|---------------|
| Weight gr.: | 1268 |
| External nominal dim. mm: | 400×300×220 h |
| Internal nominal dim. mm: | 358×258×202 h |

ORD. NO. F YA 4859 A0 00 -pallet

| | |
|-----------------------------|-----------------|
| Weight of pallet kg: | 110 |
| Qty. Containers per pallet: | 80 pcs. |
| Shipping dimensions mm: | 1200×800×2220 h |



SOLID BOTTOM

ORD. NO. F PA 5659 A0 00 -single

| | |
|------------------|------------|
| Measurements: | 6408A |
| Standard colour: | colourless |

| | |
|---------------------------|--------------|
| Weight gr.: | 1226 |
| External nominal dim. mm: | 600×400×75 h |
| Internal nominal dim. mm: | 555×355×58 h |

ORD. NO. F YA 5659 A0 00 -pallet

| | |
|-----------------------------|-----------------|
| Weight of pallet kg: | 156 |
| Qty. Containers per pallet: | 120 pcs. |
| Shipping dimensions mm: | 1200×800×1970 h |



SOLID BOTTOM

ORD. NO. F PA 6059 A0 00 -single

| | |
|------------------|------------|
| Measurements: | 6412A |
| Standard colour: | colourless |

| | |
|---------------------------|---------------|
| Weight gr.: | 1600 |
| External nominal dim. mm: | 600×400×120 h |
| Internal nominal dim. mm: | 558×357×102 h |

ORD. NO. F YA 6059 A0 00 -pallet

| | |
|-----------------------------|-----------------|
| Weight of pallet kg: | 137 |
| Qty. Containers per pallet: | 80 pcs. |
| Shipping dimensions mm: | 1200×800×2240 h |



SOLID BOTTOM

ORD. NO. F PA 7659 A0 00 -single

| | |
|------------------|------------|
| Measurements: | 6432A |
| Standard colour: | colourless |

| | |
|---------------------------|---------------|
| Weight gr.: | 3165 |
| External nominal dim. mm: | 600×400×325 h |
| Internal nominal dim. mm: | 558×357×307 h |

ORD. NO. F YA 7659 A0 00 -pallet

| | |
|-----------------------------|-----------------|
| Weight of pallet kg: | 98 |
| Qty. Containers per pallet: | 28 pcs. |
| Shipping dimensions mm: | 1200×800×2300 h |

lids



| ORD. NO. | Hinged lid mm |
|------------------------|---------------|
| F PA 0659 00 00 | 400×300 |
| Weight gr. | 340 |



| ORD. NO. | Hinged lid mm |
|------------------------|---------------|
| F PA 0959 00 00 | 600×400 |
| Weight gr. | 700 |

closing systems

The covers for the Athena series of stacking containers can be closed with nylon kick-in locks.

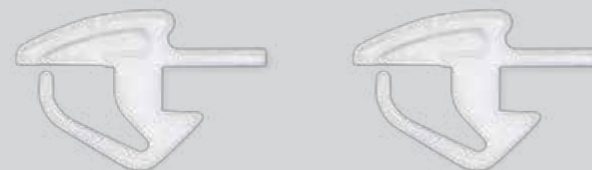

| ORD. NO. | Pair of sliding hooks suitable for Athena series containers |
|------------------------|-------------------------------------------------------------|
| F PZ 0681 00 13 | |

00 COLOURLESS

13 WHITE



Food, in order to be **preserved, stored and distributed**, requires specific storage systems. Fami has developed a new line of **boxes for food** that guarantee the **absence of chemical transfer** to food and is **highly resistant** to changes that can be caused by some **natural** food components.



| container ORD. NO. | A | B | C | D | E | F | G | H | I | L |
|--------------------|-----|-----|-----|-----|-----|-----|-----|-----|-----|-----|
| F PB 6859 A0 00 | 602 | 569 | 555 | 562 | 201 | 220 | 401 | 368 | 355 | 361 |

A0 The technical data contained in the above table is approximate. FAMI S.r.l. reserves the right to make any modifications it sees fit to improve the performance and appearance of products. The manufacturer is not liable for any printing errors.

Fami S.r.l. declares that the boxes are suitable for contact with all types of food.

The Declaration of Conformity will be provided on request.

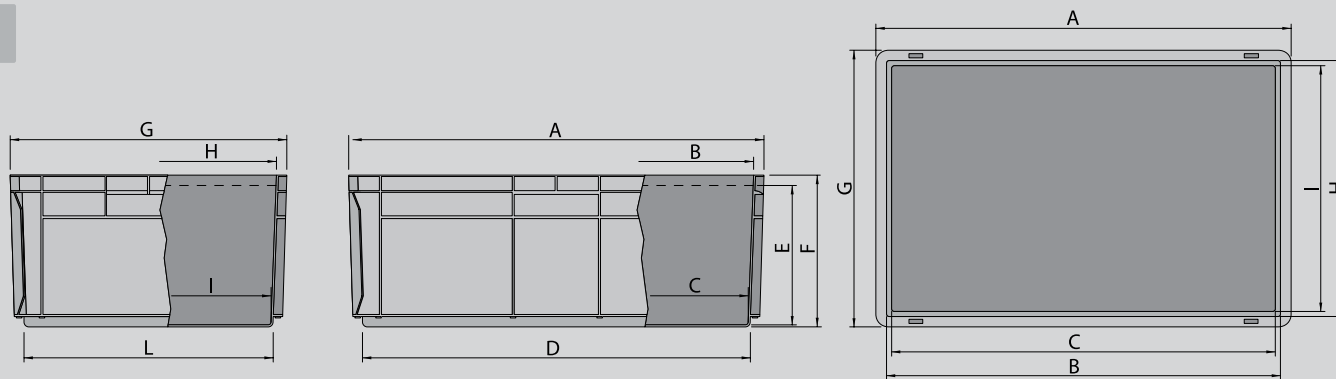

Detail of
**SOLID
BOTTOM**





SOLID BOTTOM

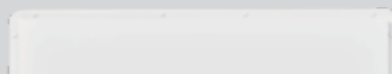

ORD. NO. F PB 6859 A0 00 **-single**

Measurements: 6422-TA

Standard colour: colourless

Weight gr.: 1992

External nominal dim. mm: 600×400×220 h

Internal nominal dim. mm: 555×355×201 h

ORD. NO. FYB 6859 A0 00 **-pallet**

Weight of pallet kg: 89

Qty. Containers per pallet: 40 pcs.

Shipping dimensions mm: 1200×800×2200 h

lid

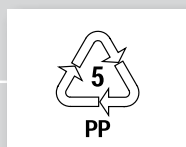

| ORD. NO. | Hinged lid mm |
|------------------------|------------------|
| F PA 0959 00 00 | 600×400 |
| Weight gr. | 700 |

closing systems

The covers for the Thema series of stacking containers can be closed with nylon kick-in locks.



| ORD. NO. |
|-------------------------------------------------------------------|
| F PZ 0681 00 13 |
| Pair of sliding hooks suitable for Thema series containers. |

00 COLOURLESS

13 WHITE



MINERVA

Building on the proven **success** of our current models, **Fami** has responded to **market demands** by ensuring the **soundness** of the product and **compliance** with **packaging standards** suitable for **food contact**.



| container ORD. NO. | A | B | C | D | E | F | G | H | I | L | M | N | O | P |
|--------------------|-----|-----|-----|-----|-----|-----|-----|-----|-----|-----|-----|-----|-----|-----|
| F PE 7659 B0 00 | 601 | 527 | 452 | 536 | 271 | 302 | 400 | 371 | 335 | 346 | 220 | 202 | 214 | 86 |
| F PE 8059 B0 00 | 602 | 526 | 453 | 535 | 372 | 403 | 399 | 368 | 335 | 346 | 220 | 202 | 284 | 117 |

B0 The technical data contained in the above table is approximate. FAMI S.r.l. reserves the right to make any modifications it sees fit to improve the performance and appearance of products. The manufacturer is not liable for any printing errors.
 Fami S.r.l. declares that the boxes are suitable for contact with all types of food.
 The Declaration of Conformity will be provided on request.

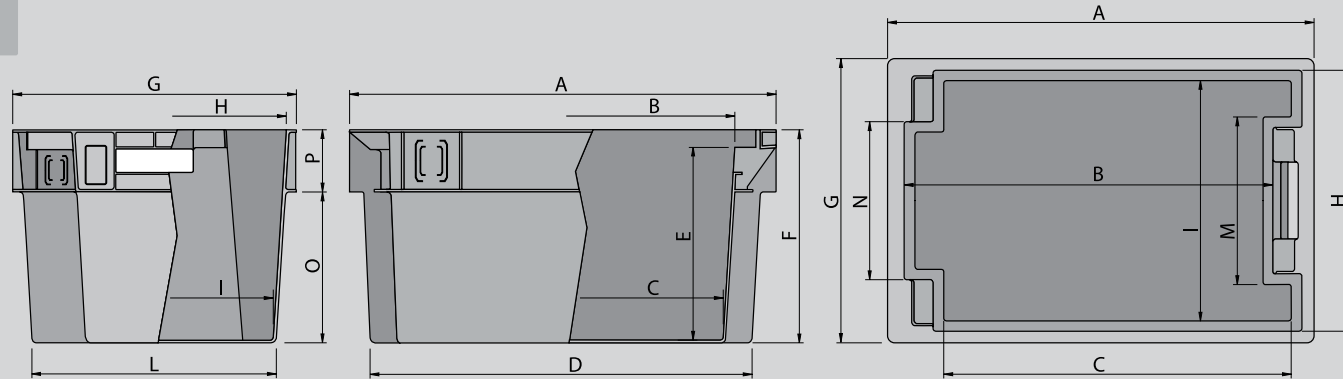

Detail of
**SOLID
BOTTOM**





SOLID BOTTOM



ORD. NO. F PE 7659 B0 00 -single

| | |
|------------------|------------|
| Measurements: | 4630B |
| Standard colour: | colourless |

| | |
|---------------------------|---------------|
| Weight gr.: | 2388 |
| External nominal dim. mm: | 600×400×300 h |
| Internal nominal dim. mm: | 452×335×271 h |

ORD. NO. FYE 7659 B0 00 -pallet

| | |
|-----------------------------|-----------------|
| Weight of pallet kg: | 200 |
| Qty. Containers per pallet: | 80 pcs. |
| Shipping dimensions mm: | 1200×800×2070 h |



SOLID BOTTOM

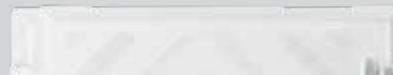

ORD. NO. F PE 8059 B0 00 -single

| | |
|------------------|------------|
| Measurements: | 4640B |
| Standard colour: | colourless |

| | |
|---------------------------|---------------|
| Weight gr.: | 2855 |
| External nominal dim. mm: | 600×400×400 h |
| Internal nominal dim. mm: | 453×335×372 h |

ORD. NO. FYE 8059 B0 00 -pallet

| | |
|-----------------------------|-----------------|
| Weight of pallet kg: | 180 |
| Qty. Containers per pallet: | 60 pcs. |
| Shipping dimensions mm: | 1200×800×2200 h |

lid

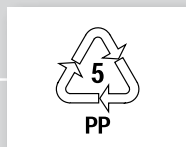

| ORD. NO. | Lid mm |
|-----------------|---------|
| F PE 0959 00 00 | 600×400 |
| Weight gr. | 1000 |

snap spring



| ORD. NO. |
|-----------------|
| F PZ 0020 00 99 |

snap spring for lid closing

00 COLOURLESS

99 GALVANISED





ECO GREEN



STACKING CONTAINERS SERIES

ATHENA

STORAGE CONTAINERS SERIES

COMPAT

BOXES SERIES

MULTIBOX



THE COLOUR OF QUALITY

Recycled plastic, **clean** energy. From materials to manufacturing, everything about this box is **environment-friendly**. A solution that protects the planet, because it gives **new life to plastic**. Available in five colours and different sizes, **ECOGREEN** is versatile, compact and tough.

Low impact, even on costs

80 years of non-stop innovation

solid but light on the environment

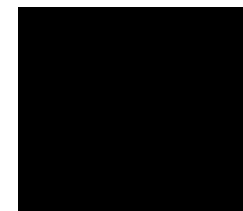

SERIES ATHENA



SERIES COMPAT



SERIES MULTIBOX



! weights can vary by $\pm 10\%$

ATHENA

! weights can vary by $\pm 10\%$

The **Athena** series **polypropylene** boxes of are available in **different heights** and can be closed **with a cover**.

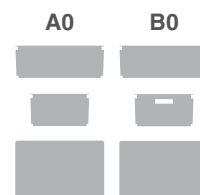

ORD. NO. F PA 4054 A0 01 -single

Measurements: 4312-AE01

Standard colour: **01** grey **XF** green **07** black **IR** blue **IS** red

Weight gr.: 782

External nominal dim. mm: 400x300x120 h

ORD. NO. F YA 4054 A0 01 -pallet

Weight of pallet kg: 134

Qty. Containers per pallet: 160 pcs.

Shipping dimensions mm: 1200x800x2230 h

SOLID BOTTOM



ORD. NO. F PA 4454 A0 01 -single

Measurements: 4317-AE01

Standard colour: **01** grey **XF** green **07** black **IR** blue **IS** red

Weight gr.: 1042

External nominal dim. mm: 400x300x170 h

ORD. NO. F YA 4454 A0 01 -pallet

Weight of pallet kg: 117

Qty. Containers per pallet: 104 pcs.

Shipping dimensions mm: 1200x800x2150 h

SOLID BOTTOM



ORD. NO. F PA 4854 A0 01 -single

Measurements: 4322-AE01

Standard colour: **01** grey **XF** green **07** black **IR** blue **IS** red

Weight gr.: 1284

External nominal dim. mm: 400x300x220 h

ORD. NO. F YA 4854 A0 01 -pallet

Weight of pallet kg: 112

Qty. Containers per pallet: 80 pcs.

Shipping dimensions mm: 1200x800x2200 h

SOLID BOTTOM



ORD. NO. F PA 5254 B0 01 -single

Measurements: 4332-BE01

Standard colour: **01** grey **XF** green **07** black **IR** blue **IS** red

Weight gr.: 1728

External nominal dim. mm: 400x300x325 h

ORD. NO. F YA 5254 B0 01 -pallet

Weight of pallet kg: 106

Qty. Containers per pallet: 56 pcs.

Shipping dimensions mm: 1200x800x2300 h

SOLID BOTTOM



SOLID BOTTOM



ORD. NO. F PA 6054 A0 01 -single

Measurements: 6412-AE01

Standard colour: **01** grey **XF** green **07** black **IR** blue **IS** red

Weight gr.: 1636

External nominal dim. mm: 600×400×120 h

ORD. NO. F YA 6054 A0 01 -pallet

Weight of pallet kg: 140

Qty. Containers per pallet: 80 pcs.

Shipping dimensions mm: 1200×800×2240 h



SOLID BOTTOM



ORD. NO. F PA 6454 A0 01 -single

Measurements: 6417-AE01

Standard colour: **01** grey **XF** green **07** black **IR** blue **IS** red

Weight gr.: 2134

External nominal dim. mm: 600×400×170 h

ORD. NO. F YA 6454 A0 01 -pallet

Weight of pallet kg: 129

Qty. Containers per pallet: 56 pcs.

Shipping dimensions mm: 1200×800×2330 h



SOLID BOTTOM



ORD. NO. F PA 6854 B0 01 -single

Measurements: 6422-BE01

Standard colour: **01** grey **XF** green **07** black **IR** blue **IS** red

Weight gr.: 2518

External nominal dim. mm: 600×400×220 h

ORD. NO. F YA 6854 B0 01 -pallet

Weight of pallet kg: 110

Qty. Containers per pallet: 40 pcs.

Shipping dimensions mm: 1200×800×2200 h



SOLID BOTTOM



ORD. NO. F PA 7654 B0 01 -single

Measurements: 6432-BE01

Standard colour: **01** grey **XF** green **07** black **IR** blue **IS** red

Weight gr.: 3228

External nominal dim. mm: 600×400×325 h

ORD. NO. F YA 7654 B0 01 -pallet

Weight of pallet kg: 99

Qty. Containers per pallet: 28 pcs.

Shipping dimensions mm: 1200×800×2300 h



LIDS

07 GREY
IR BLUE
XF GREEN
01 BLACK
IS RED



Lids 400x300



| ORD. NO. | Hinged lid mm |
|------------------------|---------------|
| F PA 0654 00 07 | 400x300 |
| F PA 0654 00 XF | 400x300 |
| F PA 0654 00 IR | 400x300 |
| F PA 0654 00 01 | 400x300 |
| F PA 0654 00 IS | 400x300 |
| Weight gr. | 340 |

Lids 600x400

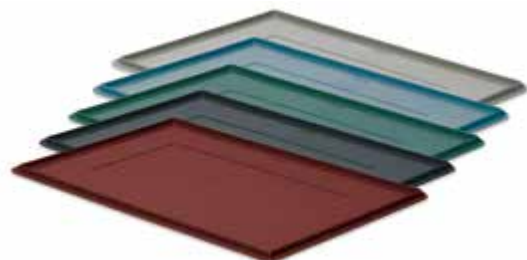

| ORD. NO. | Hinged lid mm |
|------------------------|---------------|
| F PA 0954 00 07 | 600x400 |
| F PA 0954 00 XF | 600x400 |
| F PA 0954 00 IR | 600x400 |
| F PA 0954 00 01 | 600x400 |
| F PA 0954 00 IS | 600x400 |
| Weight gr. | 700 |

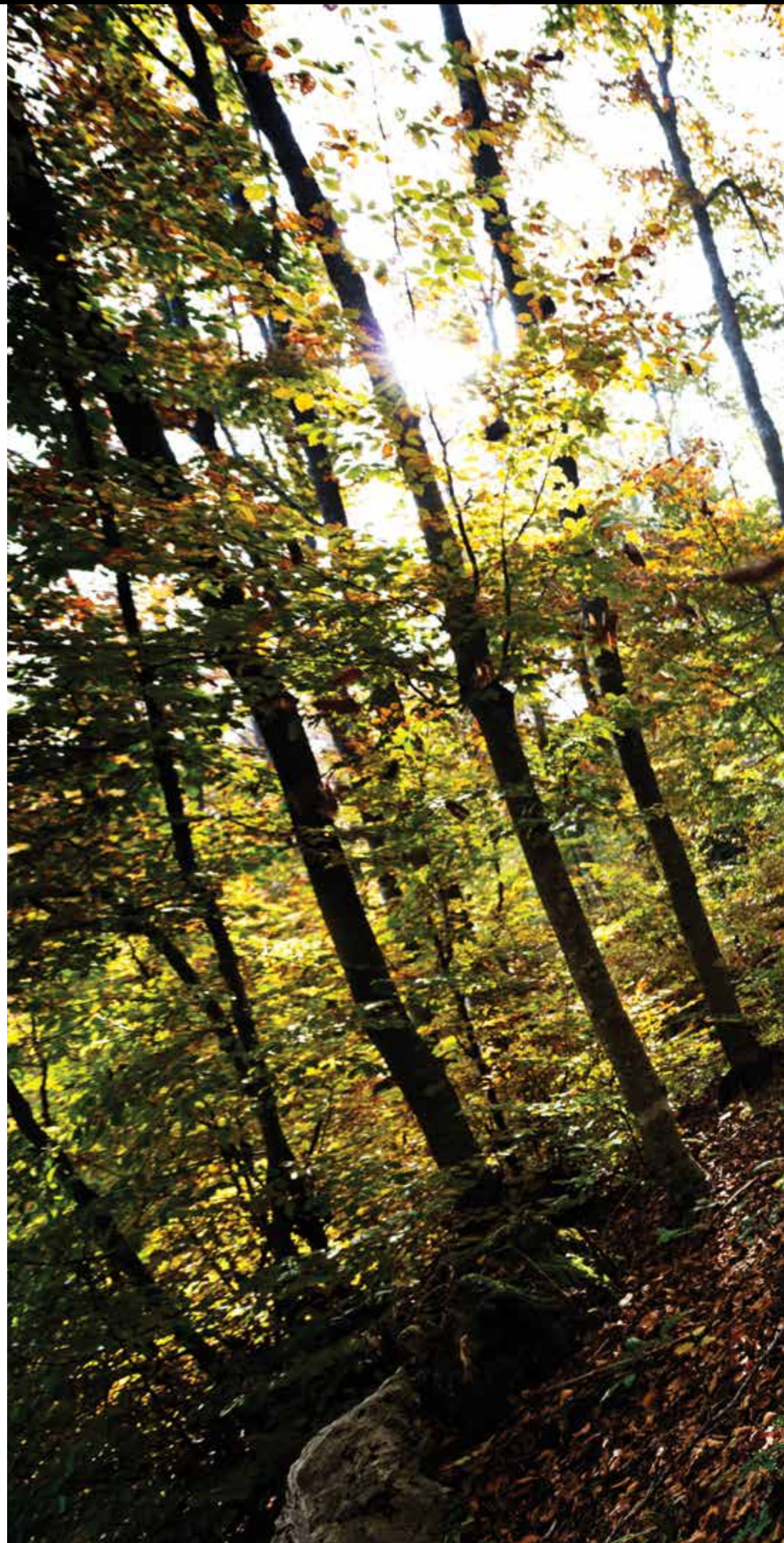



COMPAT

! weights can vary by $\pm 10\%$

The series **Compat** has a double **front wall** that ensures maximum **stability** even when **stacking**. Compat boxes are very **stable** and **secure** when **stacked** and enable easy access to the items inside even when **stacked**.



SPECIAL LABELS

Page Q1

ACCESSORIES
PAGE
J7

01 GREY
IR BLUE
XF GREEN
07 BLACK
IS RED

ORD. NO. F PM 1754 00 01 -single

Measurements: 1PL-CE01

Standard colour: 01 grey XF green 07 black IR blue IS red

Batch of: 50 pcs.

Weight gr.: 78

External nominal dim. mm: 160/140x95x75 h

ORD. NO. FYM 1754 00 01 -pallet

Weight of pallet kg: 167

Qty. Containers per pallet: 1750 pcs.

Shipping dimensions mm: 1300x1100x2000 h



SOLID BOTTOM



ORD. NO. F PM 2554 00 01 -single

Measurements: 2PL-CE01

Standard colour: 01 grey XF green 07 black IR blue IS red

Batch of: 54 pcs.

Weight gr.: 214

External nominal dim. mm: 230/200x140x130 h

ORD. NO. FYM 2554 00 01 -pallet

Weight of pallet kg: 265

Qty. Containers per pallet: 1080 pcs.

Shipping dimensions mm: 1450x1200x2100 h



SOLID BOTTOM



ORD. NO. F PM 3354 00 01 -single

Measurements: 3A2PL-CE01

Standard colour: 01 grey XF green 07 black IR blue IS red

Batch of: 21 pcs.

Weight gr.: 598

External nominal dim. mm: 350/300x200x145 h

ORD. NO. FYM 3354 00 01 -pallet

Weight of pallet kg: 183

Qty. Containers per pallet: 252 pcs.

Shipping dimensions mm: 1400x1100x2000 h



SOLID BOTTOM



SOLID BOTTOM



ORD. NO. F PM 4154 00 01 -single

Measurements: 3PL-CE01

Standard colour: 01 grey XF green 07 black IR blue IS red

Batch of: 15 pcs.

Weight gr.: 784

External nominal dim. mm: 350/300x200x200 h

ORD. NO. FYM 4154 00 01 -pallet

Weight of pallet kg: 174

Qty. Containers per pallet: 180 pcs.

Shipping dimensions mm: 1400x1100x2000 h



SOLID BOTTOM



ORD. NO. F PM 6554 00 01 -single

Measurements: 4PL-CE01

Standard colour: **01** grey **XF** green **07** black **IR** blue **IS** red

Batch of: 10 pcs.

Weight gr.: 1335

External nominal dim. mm: 500/450×300×200 h

ORD. NO. F YM 6554 00 01 -pallet

Weight of pallet kg: 132

Qty. Containers per pallet: 80 pcs.

Shipping dimensions mm: 1300×1000×2000 h



MULTIBOX

Available in **nine** different **sizes** to suit every **requirement**, Eco boxes are particularly suitable for **spare parts** and can keep everything in **order** and in plain sight for a **flexible** and **efficient** warehouse.



! weights can vary by $\pm 10\%$



ACCESSORIES
PAGE
K15

IR BLUE



ORD. NO. F PK 0554 00 IR -single

| | |
|------------------|-----------|
| Measurements: | RK3012-E |
| Standard colour: | IR blue ■ |
| Batch of: | 32 pcs. |

| | |
|---------------------------|---------------|
| Weight gr.: | 348 |
| External nominal dim. mm: | 300×120×100 h |

ORD. NO. FYK 0554 00 IR -pallet

| | |
|-----------------------------|------------------|
| Weight of pallet kg: | 202 |
| Qty. Containers per pallet: | 512 pcs. |
| Shipping dimensions mm: | 1300×1000×1700 h |

SOLID BOTTOM



ORD. NO. F PK 1554 00 IR -single

| | |
|------------------|-----------|
| Measurements: | RK4012-E |
| Standard colour: | IR blue ■ |
| Batch of: | 32 pcs. |

| | |
|---------------------------|---------------|
| Weight gr.: | 438 |
| External nominal dim. mm: | 400×120×100 h |

ORD. NO. FYK 1554 00 IR -pallet

| | |
|-----------------------------|------------------|
| Weight of pallet kg: | 192 |
| Qty. Containers per pallet: | 384 pcs. |
| Shipping dimensions mm: | 1300×1000×1700 h |

SOLID BOTTOM



ORD. NO. F PK 3054 00 IR -single

| | |
|------------------|-----------|
| Measurements: | RK5012-E |
| Standard colour: | IR blue ■ |
| Batch of: | 32 pcs. |

| | |
|---------------------------|---------------|
| Weight gr.: | 528 |
| External nominal dim. mm: | 500×120×100 h |

ORD. NO. FYK 3054 00 IR -pallet

| | |
|-----------------------------|------------------|
| Weight of pallet kg: | 154 |
| Qty. Containers per pallet: | 256 pcs. |
| Shipping dimensions mm: | 1050×1000×1700 h |

SOLID BOTTOM



ORD. NO. F PK 1054 00 IR -single

| | |
|------------------|-----------|
| Measurements: | RK3016-E |
| Standard colour: | IR blue ■ |
| Batch of: | 24 pcs. |

| | |
|---------------------------|---------------|
| Weight gr.: | 370 |
| External nominal dim. mm: | 300×160×100 h |

ORD. NO. FYK 1054 00 IR -pallet

| | |
|-----------------------------|------------------|
| Weight of pallet kg: | 166 |
| Qty. Containers per pallet: | 384 pcs. |
| Shipping dimensions mm: | 1300×1000×1700 h |

SOLID BOTTOM





SOLID BOTTOM

ORD. NO. F PK 2054 00 IR -single

| | |
|------------------|-----------|
| Measurements: | RK4016-E |
| Standard colour: | IR blue ■ |
| Batch of: | 24 pcs. |

| | |
|---------------------------|---------------|
| Weight gr.: | 448 |
| External nominal dim. mm: | 400×160×100 h |

ORD. NO. F YK 2054 00 IR -pallet

| | |
|-----------------------------|------------------|
| Weight of pallet kg: | 153 |
| Qty. Containers per pallet: | 288 pcs. |
| Shipping dimensions mm: | 1300×1000×1700 h |



SOLID BOTTOM

ORD. NO. F PK 3554 00 IR -single

| | |
|------------------|-----------|
| Measurements: | RK5016-E |
| Standard colour: | IR blue ■ |
| Batch of: | 24 pcs. |

| | |
|---------------------------|---------------|
| Weight gr.: | 540 |
| External nominal dim. mm: | 500×160×100 h |

ORD. NO. F YK 3554 00 IR -pallet

| | |
|-----------------------------|------------------|
| Weight of pallet kg: | 123 |
| Qty. Containers per pallet: | 192 pcs. |
| Shipping dimensions mm: | 1050×1000×1700 h |



SOLID BOTTOM

ORD. NO. F PK 4554 00 IR -single

| | |
|------------------|-----------|
| Measurements: | RK6016-E |
| Standard colour: | IR blue ■ |
| Batch of: | 24 pcs. |

| | |
|---------------------------|---------------|
| Weight gr.: | 662 |
| External nominal dim. mm: | 600×160×100 h |

ORD. NO. F YK 4554 00 IR -pallet

| | |
|-----------------------------|------------------|
| Weight of pallet kg: | 150 |
| Qty. Containers per pallet: | 192 pcs. |
| Shipping dimensions mm: | 1300×1000×1700 h |



SOLID BOTTOM

ORD. NO. F PK 2554 00 IR -single

| | |
|------------------|-----------|
| Measurements: | RK4024-E |
| Standard colour: | IR blue ■ |
| Batch of: | 16 pcs. |

| | |
|---------------------------|---------------|
| Weight gr.: | 644 |
| External nominal dim. mm: | 400×240×100 h |

ORD. NO. F YK 2554 00 IR -pallet

| | |
|-----------------------------|------------------|
| Weight of pallet kg: | 148 |
| Qty. Containers per pallet: | 192 pcs. |
| Shipping dimensions mm: | 1300×1000×1700 h |

HANDLES



SOLID BOTTOM

ORD. NO. F PK 4054 00 IR -single

| | |
|------------------|-----------|
| Measurements: | RK5024-E |
| Standard colour: | IR blue ■ |
| Batch of: | 16 pcs. |

| | |
|---------------------------|---------------|
| Weight gr.: | 766 |
| External nominal dim. mm: | 500×240×100 h |

ORD. NO. F YK 4054 00 IR -pallet

| | |
|-----------------------------|------------------|
| Weight of pallet kg: | 117 |
| Qty. Containers per pallet: | 128 pcs. |
| Shipping dimensions mm: | 1050×1000×1700 h |



| ORD. NO. | DIM. mm |
|-----------------|---------|
| F PK 6054 00 IR | 70×90 h |

FOR Ord. No.

F PK 0554 00 IR
F PK 1554 00 IR
F PK 3054 00 IR

| ORD. NO. | DIM. mm |
|-----------------|----------|
| F PK 6654 00 IR | 110×90 h |

FOR Ord. No.

F PK 2554 00 IR
F PK 4054 00 IR

| ORD. NO. | DIM. mm |
|-----------------|----------|
| F PK 6354 00 IR | 120×80 h |

FOR Ord. No.

F PK 1054 00 IR
F PK 2054 00 IR
F PK 3554 00 IR
F PK 4554 00 IR



1/4 Din A4

MI - flexible insert

page Q5



1/3 Din A4

MI - flexible insert

page Q5



1/4 Din A4

RS - rigid with support

page Q6



1/4 Din A4

RA - rigid with adhesive

page Q6



Din A5

MI - flexible insert

page Q7



1/4 Din A4

MF - flexible with hole

page Q7



Din A5

RS - rigid with support

page Q8



Din A5

RA - rigid with adhesive

page Q8



Din A7

RA - rigid with adhesive

page Q9



100-60

RA - rigid with adhesive

page Q10

Q1



1 LABEL HOLDER



LABEL HOLDER



types of label holders

MI ————— flexible insert

size 210×80 mm **1/4** DIN A4
210×100 mm **1/3** DIN A4
210×147 mm **DIN A5**



RA ————— rigid with adhesive

size 110×83 mm **DIN A7**
220×83 mm **1/4** DIN
220×160 mm **DIN A5**



MF ————— flexible with hole

size 210×80 mm **1/4** DIN A4



RS ————— rigid with support

size 215×80×17 mm **1/4** DIN A4
215×155×17 mm **DIN A5**



RA ————— rigid with adhesive

size 100×60×15 mm **100 - 60**



label format

| | | | | |
|-------------------------|-------------------------|-------------------------|-------------------------|--------------------------|
| 100 - 60 | 1/3 din A5 | 1/4 din A4 | 1/3 din A4 | din A5 |
| label dim. 100×60 mm | label dim. 150×67 mm | label dim. 200×67 mm | label dim. 200×85 mm | label dim. 200×135 mm |

number of paper labels per sheet according to the size

A4 - 14 - MI

1/4 DIN A4

label holder



| ORD. NO. | Dim. mm |
|-----------------|---------|
| F A9 A414 MI 96 | 210x80 |

label sheet



| ORD. NO. |
|-----------------|
| F A4 A414 04 00 |

| no. labels per sheet |
|----------------------|
| 4 |

| package of |
|------------|
| 25 pieces |



dim. single label
200x67 mm



stacking container series ATHENA Ord. No. F PA 6951 B0 01 with label holder A4 - 14 - MI insert in label holder A4 - 14 - RS



stacking container series THEMA Ord. No. F PB 6851 F0 01 with label holder A4 - 14 - MI insert in label holder A4 - 14 - RS



stacking container series ODETTE Ord. No. F PC 6851 00 05 with label holder A4 - 14 - MI



stacking container series RL KLT Ord. No. F PC 6651 00 27 with label holder A4 - 14 - MI

A4 - 13 - MI

1/3 DIN A4

label holder



| ORD. NO. | Dim. mm |
|-----------------|---------|
| F A9 A413 MI 96 | 210x100 |

label sheet



| ORD. NO. |
|-----------------|
| F A4 A413 03 00 |

| no. labels per sheet |
|----------------------|
| 3 |

| package of |
|------------|
| 35 pieces |



dim. single label
200x85 mm



Q5

A4 - 14 - RS

1/4 DIN A4

label holder

label sheet

for additional technical information see from page Q11



ORD. NO.
F A4 A414 04 00

no. labels per sheet
4

package of
25 pieces



dim. single label
200x67 mm



| ORD. NO. | Dim. mm |
|-----------------|-----------|
| F A9 A414 RS 96 | 215x80x17 |



stacking container series DELTA Ord. No. F PD 7651 AB 01 with label holder A4 - 14 - RS



stacking container series THEMA Ord. No. F PB 6851 B0 01 with label holder A4 - 14 - RA with label holder A7 - RA



stacking container series NETTUNO Ord. No. F PF 6851 BB 01 with label holder A4 - 14 - MI insert in label holder A4 - 14 - RS



stacking container series ZEUS Ord. No. F PJ 7351 00 03 with label holder A4 - 14 - RA

A4 - 14 - RA

1/4 DIN A4

label holder

label sheet

for additional technical information see from page Q11

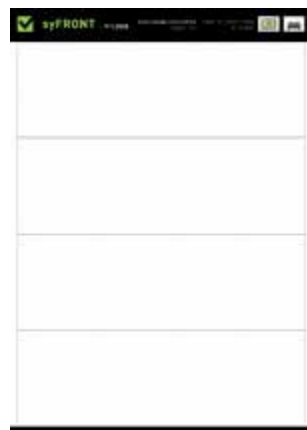

ORD. NO.
F A4 A414 04 00

no. labels per sheet
4

package of
25 pieces



dim. single label
200x67 mm



| ORD. NO. | Dim. mm |
|-----------------|---------|
| F A9 A414 RA 96 | 220x83 |

A5 - MI

DIN A5

label holder



| ORD. NO. | Dim. mm |
|-----------------|---------|
| F A9 A500 MI 96 | 210x147 |

label sheet



| ORD. NO. |
|-----------------|
| F A4 A500 02 00 |

| no. labels per sheet |
|----------------------|
| 2 |

| package of |
|------------|
| 50 pieces |



dim. single label
200x135 mm



stacking container series ATHENA Ord. No. F PA 6851 B0 01 with label holder A5 - RA



stacking container series RL KLT Ord. No. F PC 7251 00 27 with label holder A5 - RS



stacking container series RL KLT Ord. No. F PC 5051 00 27 with label holder A5 - RA



stacking container series THEMA Ord. No. F PB 6851 F0 01 with label holder A5 - RS

A4 - 14 - MF

1/4 DIN A4

label holder



| ORD. NO. | Dim. mm |
|-----------------|---------|
| F A9 A414 MF 96 | 210x80 |

label sheet



| ORD. NO. |
|-----------------|
| F A4 A513 04 00 |

| no. labels per sheet |
|----------------------|
| 4 |

| package of |
|------------|
| 25 pieces |



dim. single label
150x67 mm



A5 - RS

DIN A5

label holder

label sheet

for additional technical information see from page Q11



ORD. NO.
F A4 A500 02 00

no. labels per sheet
2

package of
50 pieces



dim. single label
200×135 mm



| ORD. NO. | Dim. mm |
|-----------------|------------|
| F A9 A500 RS 96 | 215×155×17 |



stacking container series NETTUNO Ord. No. F PF 6851 BB 01 with label holder A5 - RS

stacking container series ATHENA Ord. No. F PA 7651 B0 01 with label holder A5 - RA

stacking container series DELTA Ord. No. F PD 7651 AB 01 with label holder A5 - RA

stacking container series ODETTE Ord. No. F PC 7651 00 05 with label holder A5 - RS

A5 - RA

DIN A5

label holder

label sheet

for additional technical information see from page Q11

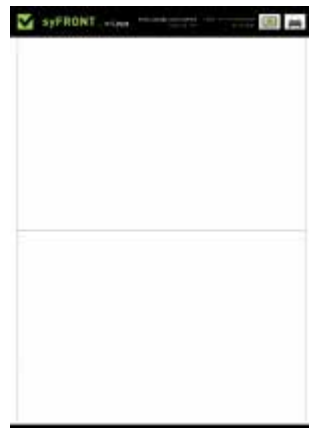

ORD. NO.
F A4 A500 02 00

no. labels per sheet
2

package of
50 pieces



dim. single label
200×135 mm



| ORD. NO. | Dim. mm |
|-----------------|---------|
| F A9 A500 RA 96 | 220×160 |

A7 - RA

DIN A7

label holder



| ORD. NO. | Dim. mm |
|-----------------|---------|
| F A9 A700 RA 96 | 110x83 |

label sheet



ORD. NO.
F A4 1006 08 00

no. labels per sheet
8

package of
15 pieces



stacking container series ODETTTE Ord. No. F PC 6851 00 05
with label holder A7 - RA



stacking container series RL KLT Ord. No. F PC 5051 00 27
with label holder A7 - RA



stacking container series THEMA Ord. No. F PB 6851 B0 01
with label holder A7 - RA



10 - 06 - RA

100 - 60

label holder



| ORD. NO. | Dim. mm |
|-----------------|-----------|
| F A9 1006 RA 96 | 100x60x15 |

label sheet



| ORD. NO. |
|-----------------|
| F A4 1006 08 00 |

| no. labels per sheet |
|----------------------|
| 8 |

| package of |
|------------|
| 15 pieces |



dim. single label
100x60 mm



stacking container series ATHENA Ord. No. F PA 2851 A0 01
with label holder 10 - 60 - RA



stacking container series ATHENA Ord. No. F PA 4451 A0 01
with label holder 10 - 60 - RA



stacking container series ATHENA Ord. No. F PA 6451 A0 01
with label holder 10 - 60 - RA





label holder with support



ord. no. F A9 A414 RS 96



ord. no. F A9 A500 RS 96



athena stacking
container ord. no.

label holder ord. no.

F A9 A414 RS 96

| edge 1/4 | |
|------------|-----------|
| short side | long side |

label holder ord. no.

F A9 A500 RS 96

| edge A5 | |
|------------|-----------|
| short side | long side |

| | | | | |
|-----------------|---|---|---|---|
| F PA 2451 A0 01 | 0 | 2 | 0 | 0 |
| F PA 2851 A0 01 | 0 | 2 | 0 | 2 |
| F PA 3251 A0 01 | 0 | 0 | 0 | 0 |
| F PA 3651 A0 01 | 0 | 0 | 0 | 0 |
| F PA 4051 A0 01 | 2 | 2 | 0 | 0 |
| F PA 4151 A0 01 | 2 | 2 | 0 | 0 |
| F PA 4051 E0 01 | 2 | 2 | 0 | 0 |
| F PA 4451 A0 01 | 2 | 2 | 2 | 2 |
| F PA 4551 A0 01 | 2 | 2 | 2 | 2 |
| F PA 4851 A0 01 | 2 | 2 | 2 | 2 |
| F PA 4851 B0 01 | 2 | 2 | 2 | 2 |
| F PA 4951 B0 01 | 2 | 2 | 2 | 2 |
| F PA 5251 A0 01 | 2 | 2 | 2 | 2 |
| F PA 5251 B0 01 | 2 | 2 | 2 | 2 |
| F PA 5651 A0 01 | 0 | 0 | 0 | 0 |
| F PA 6051 A0 01 | 2 | 2 | 0 | 0 |
| F PA 6151 A0 01 | 2 | 2 | 0 | 0 |
| F PA 6051 C0 01 | 2 | 2 | 0 | 0 |
| F PA 6051 E0 01 | 2 | 2 | 0 | 0 |
| F PA 6451 A0 01 | 2 | 2 | 2 | 2 |
| F PA 6551 A0 01 | 2 | 2 | 2 | 2 |
| F PA 6851 A0 01 | 2 | 2 | 2 | 2 |
| F PA 6851 B0 01 | 2 | 2 | 2 | 2 |
| F PA 6951 B0 01 | 2 | 2 | 2 | 2 |
| F PA 6851 F0 01 | 2 | 2 | 2 | 2 |
| F PA 7251 A0 01 | 2 | 2 | 2 | 2 |
| F PA 7251 B0 01 | 2 | 2 | 2 | 2 |
| F PA 7351 B0 01 | 2 | 2 | 2 | 2 |
| F PA 7651 A0 01 | 2 | 2 | 2 | 2 |
| F PA 7651 B0 01 | 2 | 2 | 2 | 2 |
| F PA 7751 B0 01 | 2 | 2 | 2 | 2 |
| F PA 7651 D0 01 | 2 | 2 | 2 | 2 |
| F PA 8051 B0 01 | 2 | 2 | 2 | 2 |
| F PA 8051 D0 01 | 2 | 2 | 2 | 2 |
| F PA 8051 S0 01 | 2 | 1 | 2 | 1 |
| F PA 8051 R0 01 | 1 | 2 | 1 | 2 |
| F PA 8551 A0 01 | 0 | 0 | 0 | 0 |
| F PA 8751 A0 01 | 0 | 0 | 0 | 0 |
| F PA 8951 A0 01 | 0 | 0 | 0 | 0 |
| F PA 9351 A0 01 | 0 | 0 | 0 | 0 |
| F PA 9751 A0 01 | 0 | 0 | 0 | 0 |

legend



not applicable

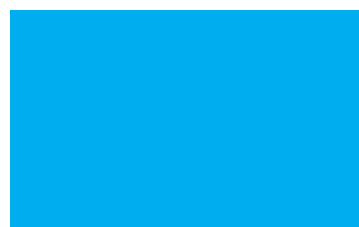

number sides applicable
without the use of the handle



number of sides applicable



label holder with adhesive



ord. no. F A9 A700 RA 96



ord. no. F A9 A414 RA 96



ord. no. F A9 A500 RA 96



athena stacking
container ord. no.

| label holder ord. no. F A9 A414 RA 96 | | label holder ord. no. F A9 A500 RA 96 | | label holder ord. no. F A9 A700 RA 96 | |
|------------------------------------------|-----------|------------------------------------------|-----------|------------------------------------------|-----------|
| adhesive 1/4 | | adhesive A5 | | adhesive A7 | |
| short side | long side | short side | long side | short side | long side |

| | | | | | | |
|-----------------|---|---|---|---|---|---|
| F PA 2451 A0 01 | 0 | 0 | 0 | 0 | 0 | 0 |
| F PA 2851 A0 01 | 0 | 0 | 0 | 0 | 2 | 2 |
| F PA 3251 A0 01 | 0 | 0 | 0 | 0 | 0 | 0 |
| F PA 3651 A0 01 | 0 | 0 | 0 | 0 | 0 | 0 |
| F PA 4051 A0 01 | 0 | 0 | 0 | 0 | 0 | 0 |
| F PA 4151 A0 01 | 0 | 0 | 0 | 0 | 0 | 0 |
| F PA 4051 E0 01 | 0 | 0 | 0 | 0 | 0 | 0 |
| F PA 4451 A0 01 | 0 | 2 | 0 | 0 | 2 | 2 |
| F PA 4551 A0 01 | 0 | 2 | 0 | 0 | 2 | 2 |
| F PA 4851 A0 01 | 0 | 2 | 0 | 1 | 2 | 2 |
| F PA 4851 B0 01 | 0 | 2 | 0 | 1 | 2 | 2 |
| F PA 4951 B0 01 | 0 | 2 | 0 | 1 | 2 | 2 |
| F PA 5251 A0 01 | 0 | 2 | 0 | 2 | 2 | 2 |
| F PA 5251 B0 01 | 0 | 2 | 0 | 2 | 2 | 2 |
| F PA 5651 A0 01 | 0 | 0 | 0 | 0 | 0 | 0 |
| F PA 6051 A0 01 | 0 | 0 | 0 | 0 | 0 | 0 |
| F PA 6151 A0 01 | 0 | 0 | 0 | 0 | 0 | 0 |
| F PA 6051 C0 01 | 0 | 0 | 0 | 0 | 0 | 0 |
| F PA 6051 E0 01 | 0 | 0 | 0 | 0 | 0 | 0 |
| F PA 6451 A0 01 | 1 | 2 | 0 | 0 | 2 | 2 |
| F PA 6551 A0 01 | 1 | 2 | 0 | 0 | 2 | 2 |
| F PA 6851 A0 01 | 2 | 2 | 0 | 2 | 2 | 2 |
| F PA 6851 B0 01 | 2 | 2 | 0 | 2 | 2 | 2 |
| F PA 6951 B0 01 | 2 | 2 | 0 | 2 | 2 | 2 |
| F PA 6851 F0 01 | 0 | 0 | 0 | 0 | 0 | 0 |
| F PA 7251 A0 01 | 2 | 2 | 2 | 2 | 2 | 2 |
| F PA 7251 B0 01 | 2 | 2 | 2 | 2 | 2 | 2 |
| F PA 7351 B0 01 | 2 | 2 | 2 | 2 | 2 | 2 |
| F PA 7651 A0 01 | 2 | 2 | 2 | 2 | 2 | 2 |
| F PA 7651 B0 01 | 2 | 2 | 2 | 2 | 2 | 2 |
| F PA 7751 B0 01 | 2 | 2 | 2 | 2 | 2 | 2 |
| F PA 7651 D0 01 | 0 | 0 | 0 | 0 | 0 | 0 |
| F PA 8051 B0 01 | 2 | 1 | 2 | 0 | 2 | 2 |
| F PA 8051 D0 01 | 0 | 0 | 0 | 0 | 0 | 0 |
| F PA 8051 S0 01 | 2 | 1 | 2 | 0 | 2 | 2 |
| F PA 8051 R0 01 | 2 | 1 | 1 | 0 | 2 | 2 |
| F PA 8551 A0 01 | 0 | 0 | 0 | 0 | 0 | 0 |
| F PA 8751 A0 01 | 2 | 2 | 0 | 0 | 2 | 2 |
| F PA 8951 A0 01 | 2 | 2 | 0 | 0 | 2 | 2 |
| F PA 9351 A0 01 | 2 | 2 | 2 | 2 | 2 | 2 |
| F PA 9751 A0 01 | 2 | 2 | 2 | 2 | 2 | 2 |

legend



not applicable

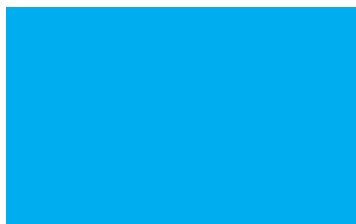

number sides applicable
without the use of the handle



number of sides applicable



label holder with support



ord. no. F A9 A414 RS 96



ord. no. F A9 A500 RS 96



thema stacking
container ord. no.

| |
|-----------------|
| F PB 6851 A0 01 |
| F PB 6851 B0 01 |
| F PB 6851 F0 01 |

| label holder ord. no. F A9 A414 RS 96 | |
|------------------------------------------|-----------|
| edge | 1/4 |
| short side | long side |
| 2 | 2 |
| 2 | 2 |
| 2 | 2 |

| label holder ord. no. F A9 A500 RS 96 | |
|------------------------------------------|-----------|
| edge | A5 |
| short side | long side |
| 2 | 2 |
| 2 | 2 |
| 2 | 2 |

label holder with adhesive



ord. no. F A9 A700 RA 96



ord. no. F A9 A414 RA 96



ord. no. F A9 A500 RA 96



thema stacking
container ord. no.

| |
|-----------------|
| F PB 6851 A0 01 |
| F PB 6851 B0 01 |
| F PB 6851 F0 01 |

| label holder ord. no. F A9 A414 RA 96 | | label holder ord. no. F A9 A500 RA 96 | | label holder ord. no. F A9 A700 RA 96 | |
|------------------------------------------|-----------|------------------------------------------|-----------|------------------------------------------|-----------|
| adhesive | 1/4 | adhesive | A5 | adhesive | A7 |
| short side | long side | short side | long side | short side | long side |
| 1 | 0 | 0 | 0 | 2 | 2 |
| 1 | 0 | 0 | 0 | 2 | 2 |
| 0 | 0 | 0 | 0 | 0 | 0 |

legend



not applicable

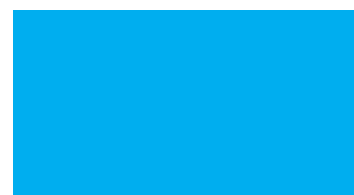

number sides applicable
without the use of the handle



number of sides applicable



label holder with support



ord. no. F A9 A414 RS 96



ord. no. F A9 A500 RS 96



odette stacking
container ord. no.

| |
|-----------------|
| F PC 2451 00 05 |
| F PC 4851 00 05 |
| F PC 6851 00 05 |
| F PC 7651 00 05 |

| label holder ord. no. | |
|-----------------------|-----------|
| F A9 A414 RS 96 | |
| edge | 1/4 |
| short side | long side |
| 0 | 2 |
| 2 | 2 |
| 2 | 2 |
| 2 | 2 |

| label holder ord. no. | |
|-----------------------|-----------|
| F A9 A500 RS 96 | |
| edge | A5 |
| short side | long side |
| 0 | 0 |
| 2 | 2 |
| 2 | 2 |
| 2 | 2 |

label holder with adhesive



ord. no. F A9 A700 RA 96



ord. no. F A9 A414 RA 96



ord. no. F A9 A500 RA 96



odette stacking
container ord. no.

| |
|-----------------|
| F PC 2451 00 05 |
| F PC 4851 00 05 |
| F PC 6851 00 05 |
| F PC 7651 00 05 |

| label holder ord. no. | | label holder ord. no. | | label holder articolo | |
|-----------------------|-----------|-----------------------|-----------|-----------------------|-----------|
| F A9 A414 RA 96 | | F A9 A500 RA 96 | | F A9 A700 RA 96 | |
| adhesive | 1/4 | adhesive | A5 | adhesive | A7 |
| short side | long side | short side | long side | short side | long side |
| 0 | 0 | 0 | 0 | 0 | 0 |
| 0 | 0 | 0 | 0 | 0 | 1 |
| 0 | 0 | 0 | 0 | 0 | 1 |
| 0 | 0 | 0 | 0 | 2 | 0 |

legend



not applicable



number sides applicable
without the use of the handle



number of sides applicable



label holder with support



ord. no. F A9 A414 RS 96



ord. no. F A9 A500 RS 96



RL KLT stacking
container ord. no.

label holder ord. no.
F A9 A414 RS 96

| edge 1/4 | |
|------------|-----------|
| short side | long side |
| | |

label holder ord. no.
F A9 A500 RS 96

| edge A5 | |
|------------|-----------|
| short side | long side |
| | |

| | | |
|-----------------|---|---|
| F PC 2351 00 27 | 0 | 2 |
| F PC 4251 00 27 | 2 | 2 |
| F PC 5051 00 27 | 2 | 2 |
| F PC 6651 00 27 | 2 | 2 |
| F PC 7251 00 27 | 2 | 2 |

| | |
|---|---|
| 0 | 2 |
| 2 | 2 |
| 2 | 2 |
| 2 | 2 |
| 2 | 2 |

| | |
|---|---|
| 2 | 2 |
| 2 | 2 |
| 2 | 2 |
| 2 | 2 |
| 2 | 2 |

| | |
|---|---|
| 0 | 0 |
| 0 | 0 |
| 2 | 2 |
| 0 | 0 |
| 2 | 2 |

| | |
|---|---|
| 0 | 0 |
| 0 | 0 |
| 2 | 2 |
| 0 | 0 |
| 2 | 2 |

label holder with adhesive



ord. no. F A9 A700 RA 96



ord. no. F A9 A414 RA 96



ord. no. F A9 A500 RA 96



RL KLT stacking
container ord. no.

label holder ord. no.
F A9 A414 RA 96

| adhesive 1/4 | |
|--------------|-----------|
| short side | long side |
| | |

label holder ord. no.
F A9 A500 RA 96

| adhesive A5 | |
|-------------|-----------|
| short side | long side |
| | |

label holder ord. no.
F A9 A700 RA 96

| adhesive A7 | |
|-------------|-----------|
| short side | long side |
| | |

| | | |
|-----------------|---|---|
| F PC 2351 00 27 | 0 | 0 |
| F PC 4251 00 27 | 0 | 0 |
| F PC 5051 00 27 | 0 | 1 |
| F PC 6651 00 27 | 0 | 0 |
| F PC 7251 00 27 | 1 | 0 |

| | |
|---|---|
| 0 | 0 |
| 0 | 0 |
| 0 | 1 |
| 0 | 0 |
| 1 | 0 |

| | |
|---|---|
| 0 | 0 |
| 0 | 0 |
| 0 | 1 |
| 0 | 0 |
| 1 | 0 |

| | |
|---|---|
| 0 | 0 |
| 0 | 0 |
| 2 | 2 |
| 0 | 0 |
| 2 | 2 |

| | |
|---|---|
| 0 | 1 |
| 0 | 1 |
| 2 | 2 |
| 0 | 2 |
| 2 | 2 |

| | |
|---|---|
| 1 | 1 |
| 1 | 1 |
| 2 | 2 |
| 2 | 2 |
| 2 | 2 |

legend



not applicable

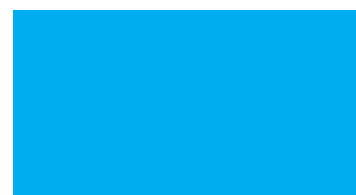

number sides applicable
without the use of the handle



number of sides applicable



label holder with support



ord. no. F A9 A414 RS 96



ord. no. F A9 A500 RS 96



R KLT stacking
container ord. no.

| label holder ord. no. F A9 A414 RS 96 | |
|------------------------------------------|-----------|
| edge | 1/4 |
| short side | long side |
| 0 | 2 |
| 2 | 2 |
| 2 | 2 |
| 2 | 2 |
| 2 | 2 |

| label holder ord. no. F A9 A500 RS 96 | |
|------------------------------------------|-----------|
| edge | A5 |
| short side | long side |
| 0 | 0 |
| 0 | 0 |
| 2 | 2 |
| 0 | 0 |
| 2 | 2 |

| |
|-----------------|
| F PC 2351 00 IG |
| F PC 4351 00 IG |
| F PC 5151 00 IG |
| F PC 6751 00 IG |
| F PC 7351 00 IG |

| |
|---|
| 0 |
| 2 |
| 2 |
| 2 |
| 2 |

| |
|---|
| 2 |
| 2 |
| 2 |
| 2 |
| 2 |

| |
|---|
| 0 |
| 0 |
| 2 |
| 0 |
| 2 |

| |
|---|
| 0 |
| 0 |
| 2 |
| 0 |
| 2 |

label holder with adhesive



ord. no. F A9 A700 RA 96



ord. no. F A9 A414 RA 96



ord. no. F A9 A500 RA 96



R KLT stacking
container ord. no.

| label holder ord. no. F A9 A414 RA 96 | |
|------------------------------------------|-----------|
| adhesive | 1/4 |
| short side | long side |
| 0 | 0 |
| 0 | 0 |
| 0 | 1 |
| 0 | 0 |
| 1 | 0 |

| label holder ord. no. F A9 A500 RA 96 | |
|------------------------------------------|-----------|
| adhesive | A5 |
| short side | long side |
| 0 | 0 |
| 0 | 0 |
| 0 | 1 |
| 0 | 0 |
| 1 | 0 |

| label holder ord. no. F A9 A700 RA 96 | |
|------------------------------------------|-----------|
| adhesive | A7 |
| short side | long side |
| 0 | 0 |
| 0 | 0 |
| 2 | 2 |
| 0 | 0 |
| 2 | 2 |

| |
|-----------------|
| F PC 2351 00 IG |
| F PC 4351 00 IG |
| F PC 5151 00 IG |
| F PC 6751 00 IG |
| F PC 7351 00 IG |

| |
|---|
| 0 |
| 0 |
| 0 |
| 0 |
| 1 |

| |
|---|
| 0 |
| 0 |
| 1 |
| 0 |
| 0 |

| |
|---|
| 0 |
| 0 |
| 1 |
| 0 |
| 0 |

| |
|---|
| 0 |
| 0 |
| 2 |
| 0 |
| 2 |

| |
|---|
| 0 |
| 0 |
| 2 |
| 0 |
| 2 |

legend



not applicable

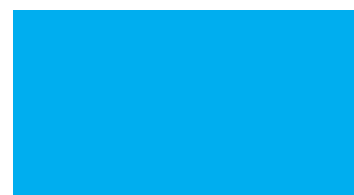

number sides applicable
without the use of the handle



number of sides applicable



label holder with support



ord. no. F A9 A414 RS 96



ord. no. F A9 A500 RS 96



minerva stacking
container ord. no.

| label holder ord. no. | |
|-----------------------|-----------|
| F A9 A414 RS 96 | |
| edge | 1/4 |
| short side | long side |

| label holder ord. no. | |
|-----------------------|-----------|
| F A9 A500 RS 96 | |
| edge | A5 |
| short side | long side |

| | | | | |
|-----------------|---|---|---|---|
| F PE 6851 B0 01 | 0 | 0 | 0 | 0 |
| F PE 6851 F0 01 | 0 | 0 | 0 | 0 |
| F PE 7651 B0 01 | 0 | 2 | 0 | 0 |
| F PE 7651 F0 01 | 0 | 2 | 0 | 0 |
| F PE 8051 B0 01 | 0 | 2 | 0 | 0 |
| F PE 8051 F0 01 | 0 | 2 | 0 | 0 |

label holder with adhesive



ord. no. F A9 A700 RA 96



ord. no. F A9 A414 RA 96



ord. no. F A9 A500 RA 96



minerva stacking
container ord. no.

| label holder ord. no. | | label holder ord. no. | | label holder ord. no. | |
|-----------------------|-----------|-----------------------|-----------|-----------------------|-----------|
| F A9 A414 RA 96 | | F A9 A500 RA 96 | | F A9 A700 RA 96 | |
| adhesive | 1/4 | adhesive | A5 | adhesive | A7 |
| short side | long side | short side | long side | short side | long side |

| | | | | | | |
|-----------------|---|---|---|---|---|---|
| F PE 6851 B0 01 | 0 | 2 | 0 | 0 | 2 | 2 |
| F PE 6851 F0 01 | 0 | 0 | 0 | 0 | 0 | 0 |
| F PE 7651 B0 01 | 0 | 2 | 0 | 2 | 2 | 2 |
| F PE 7651 F0 01 | 0 | 0 | 0 | 0 | 0 | 0 |
| F PE 8051 B0 01 | 0 | 2 | 0 | 2 | 2 | 2 |
| F PE 8051 F0 01 | 0 | 0 | 0 | 0 | 0 | 0 |

legend



not applicable



number sides applicable
without the use of the handle



number of sides applicable



label holder with support



ord. no. F A9 A414 RS 96



ord. no. F A9 A500 RS 96



delta stacking
container ord. no.

| label holder ord. no. F A9 A414 RS 96 | | label holder ord. no. F A9 A500 RS 96 | |
|------------------------------------------|-----------|------------------------------------------|-----------|
| edge 1/4 | | edge A5 | |
| short side | long side | short side | long side |

| | | | | |
|-----------------|---|---|---|---|
| F PD 6851 A0 01 | 0 | 0 | 0 | 0 |
| F PD 7651 A0 01 | 0 | 2 | 0 | 0 |
| F PD 8051 A0 01 | 0 | 2 | 0 | 0 |
| F PD 6851 AB 01 | 0 | 0 | 0 | 0 |
| F PD 7651 AB 01 | 0 | 2 | 0 | 0 |
| F PD 8051 AB 01 | 0 | 2 | 0 | 0 |
| F PD 6851 AA 01 | 0 | 0 | 0 | 0 |
| F PD 7651 AA 01 | 0 | 0 | 0 | 0 |
| F PD 8051 AA 01 | 0 | 0 | 0 | 0 |

label holder with adhesive



ord. no. F A9 A700 RA 96



ord. no. F A9 A414 RA 96



ord. no. F A9 A500 RA 96



delta stacking
container ord. no.

| label holder ord. no. F A9 A414 RA 96 | | label holder ord. no. F A9 A500 RA 96 | | label holder ord. no. F A9 A700 RA 96 | |
|------------------------------------------|-----------|------------------------------------------|-----------|------------------------------------------|-----------|
| adhesive 1/4 | | adhesive A5 | | adhesive A7 | |
| short side | long side | short side | long side | short side | long side |

| | | | | | | |
|-----------------|---|---|---|---|---|---|
| F PD 6851 A0 01 | 2 | 2 | 2 | 2 | 2 | 2 |
| F PD 7651 A0 01 | 2 | 2 | 2 | 2 | 2 | 2 |
| F PD 8051 A0 01 | 2 | 2 | 2 | 2 | 2 | 2 |
| F PD 6851 AB 01 | 2 | 2 | 2 | 2 | 2 | 2 |
| F PD 7651 AB 01 | 2 | 2 | 2 | 2 | 2 | 2 |
| F PD 8051 AB 01 | 2 | 2 | 2 | 2 | 2 | 2 |
| F PD 6851 AA 01 | 2 | 2 | 2 | 2 | 2 | 2 |
| F PD 7651 AA 01 | 2 | 2 | 2 | 2 | 2 | 2 |
| F PD 8051 AA 01 | 2 | 2 | 2 | 2 | 2 | 2 |

legend



not applicable

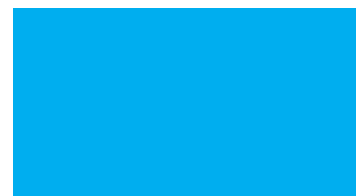

number sides applicable
without the use of the handle



number of sides applicable



➔ label holder applicable only on non collapsible container

label holder with support



ord. no. F A9 A414 RS 96



ord. no. F A9 A500 RS 96



nettuno stacking
container ord. no.

| |
|-----------------|
| F PF 4851 BB 01 |
| F PF 4851 BA 01 |
| F PF 6851 BB 01 |
| F PF 6851 BA 01 |
| F PF 7651 BB 01 |
| F PF 7651 BA 01 |

label holder ord. no.
F A9 A414 RS 96

| | |
|------------|-----------|
| edge | 1/4 |
| short side | long side |

| |
|----|
| 2* |
| 0 |
| 2* |
| 0 |
| 2* |
| 0 |

| |
|----|
| 2* |
| 0 |
| 2* |
| 0 |
| 2* |
| 0 |

label holder ord. no.
F A9 A500 RS 96

| | |
|------------|-----------|
| edge | A5 |
| short side | long side |

| |
|----|
| 2* |
| 0 |
| 2* |
| 0 |
| 2* |
| 0 |

| |
|----|
| 2* |
| 0 |
| 2* |
| 0 |
| 2* |
| 0 |

**only for non collapsible containers

label holder with adhesive



ord. no. F A9 A700 RA 96



ord. no. F A9 A414 RA 96



ord. no. F A9 A500 RA 96



nettuno stacking
container ord. no.

| |
|-----------------|
| F PF 4851 BB 01 |
| F PF 4851 BA 01 |
| F PF 6851 BB 01 |
| F PF 6851 BA 01 |
| F PF 7651 BB 01 |
| F PF 7651 BA 01 |

label holder ord. no.
F A9 A414 RA 96

| | |
|------------|-----------|
| adhesive | 1/4 |
| short side | long side |

| |
|---|
| 0 |
| 0 |
| 0 |
| 0 |
| 0 |
| 0 |

label holder ord. no.
F A9 A500 RA 96

| | |
|------------|-----------|
| adhesive | A5 |
| short side | long side |

| |
|---|
| 0 |
| 0 |
| 0 |
| 0 |
| 0 |
| 0 |

label holder ord. no.
F A9 A700 RA 96

| | |
|------------|-----------|
| adhesive | A7 |
| short side | long side |

| | |
|---|---|
| 0 | 0 |
| 0 | 0 |
| 0 | 0 |
| 0 | 0 |
| 0 | 2 |
| 0 | 2 |

**only for non collapsible containers

legend



not applicable

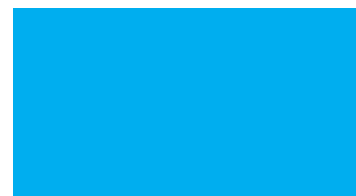

number sides applicable
without the use of the handle



number of sides applicable



label holder with adhesive



ord. no. F A9 A700 RA 96



ord. no. F A9 A414 RA 96



ord. no. F A9 A500 RA 96



zeus stacking
container ord. no.

| label holder ord. no. F A9 A414 RA 96 | | label holder ord. no. F A9 A500 RA 96 | | label holder ord. no. F A9 A700 RA 96 | |
|------------------------------------------|-----------|------------------------------------------|-----------|------------------------------------------|-----------|
| adhesive | 1/4 | adhesive | A5 | adhesive | A7 |
| short side | long side | short side | long side | short side | long side |

| | | | | | | |
|-----------------|---|---|---|---|---|---|
| F PJ 2551 00 .. | 0 | 0 | 0 | 0 | 0 | 2 |
| F PJ 3351 00 .. | 0 | 2 | 0 | 0 | 0 | 2 |
| F PJ 5751 00 .. | 1 | 2 | 0 | 0 | 1 | 2 |
| F PJ 6551 00 .. | 1 | 2 | 0 | 2 | 1 | 2 |
| F PJ 7351 00 .. | 1 | 2 | 1 | 2 | 1 | 2 |
| F PJ 8951 00 .. | 0 | 0 | 0 | 0 | 2 | 2 |

label holder with adhesive storage containers series zeus-compat



ord. no. F A9 A700 RA 96



ord. no. F A9 A414 RA 96



ord. no. F A9 A500 RA 96



zeus-compat
storage container
ord. no.

| label holder ord. no. F A9 A414 RA 96 | | label holder ord. no. F A9 A500 RA 96 | | label holder ord. no. F A9 A700 RA 96 | |
|------------------------------------------|-----------|------------------------------------------|-----------|------------------------------------------|-----------|
| adhesive | 1/4 | adhesive | A5 | adhesive | A7 |
| short side | long side | short side | long side | short side | long side |

| | | | | | | |
|-----------------|---|---|---|---|---|---|
| F PM 1751 00 .. | 0 | 0 | 0 | 0 | 0 | 0 |
| F PM 2551 00 .. | 0 | 0 | 0 | 0 | 0 | 2 |
| F PM 3351 00 .. | 0 | 2 | 0 | 0 | 0 | 2 |
| F PM 4151 00 .. | 0 | 2 | 0 | 2 | 0 | 2 |
| F PL 4951 00 .. | 0 | 2 | 0 | 0 | 0 | 2 |
| F PM 5751 00 .. | 0 | 2 | 0 | 0 | 0 | 2 |
| F PM 6551 00 .. | 0 | 2 | 0 | 2 | 0 | 2 |
| F PM 7351 00 .. | 0 | 2 | 0 | 2 | 1 | 2 |
| F PM 8151 00 .. | 0 | 0 | 0 | 0 | 1 | 2 |
| F PM 8951 00 .. | 0 | 0 | 0 | 0 | 1 | 2 |

legend



not applicable

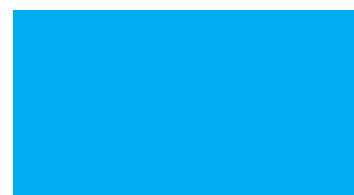

number sides applicable
without the use of the handle



number of sides applicable



PERSONALISED LOGOS





ORD. NO. **F ZA 0001 00 00**

steel insert with your logo inserted in the mold
Minimum production quantities to be agreed upon.

The marking service is available for a minimum order of 50 containers

ORD. NO. **F ZA 0010 00 00**

insert up to 100 cm²

ORD. NO. **F ZA 0020 00 00**

insert from 101 to 250 cm²

ORD. NO. **F ZA 0030 00 00**

insert from 251 to cm²



The codes shown are for marking in standard colors

green ■, red ■, blue ■, yellow ■,
black ■ e white □

For special colors, please request an estimate.

The codes are valid for one-color marking of logos, lettering and progressive numbering. For marking in multiple colors please request an estimate.

The insert remains the property of Fami.

The Fami agrees to store the inserts for a period of 12 months from the date of last use.

ORD. NO.

height

article description

| | | |
|-----------------|---------|---------------------------------------------------------------------------------|
| F ZA 0091 10 00 | H=10 mm | from n°.... to n°.... - 1 short side per box - quantity price from 50 to 99 |
| F ZA 0091 20 00 | H=10 mm | from n°.... to n°.... - 1 long side per box - quantity price from 50 to 99 |
| F ZA 0091 30 00 | H=10 mm | from n°.... to n°.... - 2 short sides per box - quantity price from 50 to 99 |
| F ZA 0091 40 00 | H=10 mm | from n°.... to n°.... - 2 long sides per box - quantity price from 50 to 99 |
| F ZA 0093 10 00 | H=10 mm | from n°.... to n°.... - 1 short side per box - quantity price from 100 to 499 |
| F ZA 0093 20 00 | H=10 mm | from n°.... to n°.... - 1 long side per box - quantity price from 100 to 499 |
| F ZA 0093 30 00 | H=10 mm | from n°.... to n°.... - 2 short sides per box - quantity price from 100 to 499 |
| F ZA 0093 40 00 | H=10 mm | from n°.... to n°.... - 2 long sides per box - quantity price from 100 to 499 |
| F ZA 0095 10 00 | H=10 mm | from n°.... to n°.... - 1 short side per box - quantity price from 500 to |
| F ZA 0095 20 00 | H=10 mm | from n°.... to n°.... - 1 long side per box - quantity price from 500 to |
| F ZA 0095 30 00 | H=10 mm | from n°.... to n°.... - 2 short sides per box - quantity price from 500 to |
| F ZA 0095 40 00 | H=10 mm | from n°.... to n°.... - 2 long sides per box - quantity price from 500 to |



ORD. NO.

article description

| | |
|-----------------|---------------------------------------------------------|
| F ZA 0100 10 00 | 1 short side per box - quantity price from 50 to 99 |
| F ZA 0100 20 00 | 1 long side per box - quantity price from 50 to 99 |
| F ZA 0100 30 00 | 2 short sides per box - quantity price from 50 to 99 |
| F ZA 0100 40 00 | 2 long sides per box - quantity price from 50 to 99 |
| F ZA 0300 10 00 | 1 short side per box - quantity price from 100 to 499 |
| F ZA 0300 20 00 | 1 long side per box - quantity price from 100 to 499 |
| F ZA 0300 30 00 | 2 short sides per box - quantity price from 100 to 499 |
| F ZA 0300 40 00 | 2 long sides per box - quantity price from 100 to 499 |
| F ZA 0500 10 00 | 1 short side per box - quantity price from 500 to |
| F ZA 0500 20 00 | 1 long side per box - quantity price from 500 to |
| F ZA 0500 30 00 | 2 short sides per box - quantity price from 500 to |
| F ZA 0500 40 00 | 2 long sides per box - quantity price from 500 to |
| F ZA 5700 10 00 | 1 short side per container |
| F ZA 5700 20 00 | 1 long side per container |
| F ZA 5700 30 00 | 2 short sides per container |
| F ZA 5700 40 00 | 2 long sides per container |



marking with **standard letters h 10 mm**

ORD. NO.

height

article description

| | | |
|-----------------|---------|---------------------------------------------------------|
| F ZA 1100 10 00 | H=10 mm | 1 short side per box - quantity price from 50 to 99 |
| F ZA 1100 20 00 | H=10 mm | 1 long side per box - quantity price from 50 to 99 |
| F ZA 1100 30 00 | H=10 mm | 2 short sides per box - quantity price from 50 to 99 |
| F ZA 1100 40 00 | H=10 mm | 2 long sides per box - quantity price from 50 to 99 |
| F ZA 1300 10 00 | H=10 mm | 1 short side per box - quantity price from 100 to 499 |
| F ZA 1300 20 00 | H=10 mm | 1 long side per box - quantity price from 100 to 499 |
| F ZA 1300 30 00 | H=10 mm | 2 short sides per box - quantity price from 100 to 499 |
| F ZA 1300 40 00 | H=10 mm | 2 long sides per box - quantity price from 100 to 499 |
| F ZA 1500 10 00 | H=10 mm | 1 short side per box - quantity price from 500 to |
| F ZA 1500 20 00 | H=10 mm | 1 long side per box - quantity price from 500 to |
| F ZA 1500 30 00 | H=10 mm | 2 short sides per box - quantity price from 500 to |
| F ZA 1500 40 00 | H=10 mm | 2 long sides per box - quantity price from 500 to |



marking with **standard letters h 15 mm**

ORD. NO.

height

article description

| | | |
|-----------------|---------|---------------------------------------------------------|
| F ZA 2100 10 00 | H=15 mm | 1 short side per box - quantity price from 50 to 99 |
| F ZA 2100 20 00 | H=15 mm | 1 long side per box - quantity price from 50 to 99 |
| F ZA 2100 30 00 | H=15 mm | 2 short sides per box - quantity price from 50 to 99 |
| F ZA 2100 40 00 | H=15 mm | 2 long sides per box - quantity price from 50 to 99 |
| F ZA 2300 10 00 | H=15 mm | 1 short side per box - quantity price from 100 to 499 |
| F ZA 2300 20 00 | H=15 mm | 1 long side per box - quantity price from 100 to 499 |
| F ZA 2300 30 00 | H=15 mm | 2 short sides per box - quantity price from 100 to 499 |
| F ZA 2300 40 00 | H=15 mm | 2 long sides per box - quantity price from 100 to 499 |
| F ZA 2500 10 00 | H=15 mm | 1 short side per box - quantity price from 500 to |
| F ZA 2500 20 00 | H=15 mm | 1 long side per box - quantity price from 500 to |
| F ZA 2500 30 00 | H=15 mm | 2 short sides per box - quantity price from 500 to |
| F ZA 2500 40 00 | H=15 mm | 2 long sides per box - quantity price from 500 to |



R7

marking with **s** standard letters h 30 mm

ORD. NO.

height

article description

| | | |
|-----------------|---------|---------------------------------------------------------|
| F ZA 5100 10 00 | H=30 mm | 1 short side per box - quantity price from 50 to 99 |
| F ZA 5100 20 00 | H=30 mm | 1 long side per box - quantity price from 50 to 99 |
| F ZA 5100 30 00 | H=30 mm | 2 short sides per box - quantity price from 50 to 99 |
| F ZA 5100 40 00 | H=30 mm | 2 long sides per box - quantity price from 50 to 99 |
| F ZA 5300 10 00 | H=30 mm | 1 short side per box - quantity price from 100 to 499 |
| F ZA 5300 20 00 | H=30 mm | 1 long side per box - quantity price from 100 to 499 |
| F ZA 5300 30 00 | H=30 mm | 2 short sides per box - quantity price from 100 to 499 |
| F ZA 5300 40 00 | H=30 mm | 2 long sides per box - quantity price from 100 to 499 |
| F ZA 5500 10 00 | H=30 mm | 1 short side per box - quantity price from 500 to |
| F ZA 5500 20 00 | H=30 mm | 1 long side per box - quantity price from 500 to |
| F ZA 5500 30 00 | H=30 mm | 2 short sides per box - quantity price from 500 to |
| F ZA 5500 40 00 | H=30 mm | 2 long sides per box - quantity price from 500 to |



PLASTIC CONTAINERS AND PALLETS



PLASTIC CONTAINERS

Made in high-density **polyethylene** for the **chemical**, food, **textile** and **clothing industry**.

- optimal weight **volume ratio**
- easy to **handle** and **suitable** for **manual handling**, with **pallet trucks**, **fork lift** with **wheels**
- stackable and easy to clean due to the **smooth bottom** and **inner walls**, resists weathering and has passed our **physical**, **chemical** and **mechanical** tests with **excellent results**
- **optimal** mechanical resistance even when **stacking** due to the **reinforced ridges**
- resistant to **temperatures** from **-20°C** to **+70°C**



ORD. NO. F PT 1040 00 01

| | |
|------------------|----------------|
| Standard colour: | 01 grey ■ |
| Dim. mm: | 1000×640×655 h |
| Load capacity: | 150 kg |
| Capacity litres: | 280 |



ORD. NO. F PT 3040 00 01

| | |
|------------------|----------------|
| Standard colour: | 01 grey ■ |
| Dim. mm: | 1165×790×800 h |
| Load capacity: | 250 kg |
| Capacity litres: | 520 |



ORD. NO. F PT 5040 00 01

| | |
|------------------|----------------|
| Standard colour: | 01 grey ■ |
| Dim. mm: | 1165×790×800 h |
| Load capacity: | 300 kg |
| Capacity litres: | 520 |

with wheels



ORD. NO. F PT 1140 00 01

| | |
|------------------|----------------|
| Standard colour: | 01 grey ■ |
| Dim. mm: | 1000×640×790 h |
| Load capacity: | 150 kg |
| Capacity litres: | 280 |
| Ø Wheels mm: | 100 |

ORD. NO. F PT 1240 00 01

| | |
|------------------|----------------|
| Standard colour: | 01 grey ■ |
| Dim. mm: | 1000×640×815 h |
| Load capacity: | 150 kg |
| Capacity litres: | 280 |
| Ø Wheels mm: | 125 |

Supplied with 4 swivel wheels without brake



ORD. NO. F PT 3140 00 01

| | |
|------------------|----------------|
| Standard colour: | 01 grey ■ |
| Dim. mm: | 1165×790×935 h |
| Load capacity: | 200 kg |
| Capacity litres: | 520 |
| Ø Wheels mm: | 100 |

ORD. NO. F PT 3240 00 01

| | |
|------------------|----------------|
| Standard colour: | 01 grey ■ |
| Dim. mm: | 1165×790×960 h |
| Load capacity: | 250 kg |
| Capacity litres: | 520 |
| Ø Wheels mm: | 125 |

Supplied with 4 swivel wheels without brake

lids



| ORD. NO. | DIM. mm |
|------------------------|----------|
| F PT 7040 00 01 | 1000×640 |

Lids for ORD. NO. F PT 1040 00 01 /
F PT 1140 00 01 / F PT 1240 00 01



| ORD. NO. | DIM. mm |
|------------------------|----------|
| F PT 7540 00 01 | 1165×790 |

Lids for ORD. NO. F PT 5040 00 01 / F PT 3040
00 01 / F PT 3140 00 01 / F PT 3240 00 01

handles for transport



| ORD. NO. | length |
|------------------------|--------|
| F PT 8010 00 01 | 480 |

For ORD. NO. F PT 1040 / 1140 / 1240

| ORD. NO. | length |
|------------------------|--------|
| F PT 8020 00 01 | 670 |

For ORD. NO. F PT 5040 / 3040 / 3140 / 3240

RECYCLED CONTAINERS



ORD. NO. F PT 1040 00 07

| | |
|------------------|----------------|
| Standard colour: | 07 black ■ |
| Dim. mm: | 1000×640×655 h |
| Load capacity: | 150 kg |
| Capacity litres: | 280 |



ORD. NO. F PT 3040 00 07

| | |
|------------------|----------------|
| Standard colour: | 07 black ■ |
| Dim. mm: | 1165×790×800 h |
| Load capacity: | 250 kg |
| Capacity litres: | 520 |



ORD. NO. F PT 5040 00 07

| | |
|------------------|----------------|
| Standard colour: | 07 black ■ |
| Dim. mm: | 1165×790×800 h |
| Load capacity: | 300 kg |
| Capacity litres: | 520 |

07 BLACK



PALLETS

Constructed in high density **polyethylene**, designed to guarantee **maximum resistance to intensive operating stress**. Extremely useful for the **transport of palletizable goods**, especially **lightweight** and **easy to handle**, suitable for all requirements in load **handling**. Pallets are totally **washable**, thus guaranteeing **maximum hygiene**.



ORD. NO. F PU 2240 00 13

Dimensions mm: 1200×800×150 h

Static Load capacity kg: 4000

Dynamic Load capacity kg: 1500

Weight kg: 13,70

ORD. NO. F PU 3240 00 13

Dimensions mm: 1200×1000×150 h

Static Load capacity kg: 4000

Dynamic Load capacity kg: 1500

Weight kg: 16,90

For Athena and Thema containers with galvanised steel edges on all 4 sides

ORD. NO. F PU 2140 00 13

Dimensions mm: 1200×800×150 h

Static Load capacity kg: 4000

Dynamic Load capacity kg: 1500

Weight kg: 14,50

ORD. NO. F PU 3140 00 13

Dimensions mm: 1200×1000×150 h

Static Load capacity kg: 4000

Dynamic Load capacity kg: 1500

Weight kg: 17,00

For Odette containers with galvanised steel edges on all 4 sides

ORD. NO. F PU 2040 00 13

Dimensions mm: 1200×800×130 h

Static Load capacity kg: 4000

Dynamic Load capacity kg: 1500

Weight kg: 12,30

ORD. NO. F PU 3040 00 13

Dimensions mm: 1200×1000×130 h

Static Load capacity kg: 4000

Dynamic Load capacity kg: 1500

Weight kg: 15,10

13 WHITE

